

EG4[®] FLEXBOSS21 HYBRID INVERTER

USER MANUAL



©2026 EG4[®] ELECTRONICS, LLC. ALL RIGHTS RESERVED.
VERSION 1.3.5 | INFORMATION SUBJECT TO CHANGE WITHOUT NOTICE.
MODEL#: IV-16000-HYB-AW-FX-XX (XX is a number between 00-99)



TABLE OF CONTENTS

1.	TECHNICAL SPECIFICATIONS.....	1
2.	ABBREVIATIONS.....	4
3.	INVERTER SAFETY.....	5
3.1	SAFETY INSTRUCTIONS.....	5
3.2	IMPORTANT SAFETY NOTIFICATIONS.....	5
4.	SÉCURITÉ DE L'ONDULEUR.....	7
4.1	INSTRUCTIONS DE SÉCURITÉ.....	7
4.2	NOTIFICATIONS DE SÉCURITÉ IMPORTANTES.....	7
5.	PRODUCT OVERVIEW.....	9
5.1	PACKING LIST.....	9
5.2	FEATURES OVERVIEW.....	10
5.3	PRODUCT FEATURE IDENTIFICATION.....	11
5.4	PRODUCT DIMENSIONS.....	14
5.5	SYSTEM DIAGRAMS.....	16
6.	STORING THE INVERTER.....	17
7.	SYSTEM INSTALLATION.....	18
7.1	TOOLS NEEDED FOR INSTALLATION.....	18
7.2	LOCATION SELECTION AND INSTALLATION.....	19
7.3	CONNECTION OVERVIEW.....	22
7.4	BATTERY CONNECTIONS.....	23
7.5	PV CONNECTIONS.....	25
7.6	AC WIRING INFORMATION.....	27
7.7	PARALLEL SYSTEM CONNECTION.....	30
7.8	GRID, LOAD, AND AC INFORMATION.....	34
7.9	RAPID SHUTDOWN/ESS DISCONNECT.....	35
8.	INVERTER START-UP AND SHUTDOWN PROCEDURE.....	36
9.	WORKING WITH A GRIDBOSS.....	36
10.	MONITOR SYSTEM SETUP.....	37
10.1	WI-FI/4G DONGLE CONNECTION.....	38
10.2	CONNECTIVITY REQUIREMENTS.....	38
10.3	ONLINE MONITORING SYSTEM USER INTERFACE.....	39
10.4	EG4® MONITOR APP SETUP.....	39
10.5	ENABLE APP NOTIFICATIONS.....	41
10.6	LOCAL MONITORING SETUP WITH THE EG4® MONITOR APP.....	43
11.	MONITOR CENTER SETTINGS.....	43
12.	WORKING MODES AND RELATED SETTINGS.....	44
13.	POWER CONTROL SYSTEM.....	51
13.1	EXPORT LIMITING FROM ALL SOURCES (PEL).....	51
13.2	ESS MODE.....	53
14.	FIRMWARE UPDATES.....	55
14.1	FIRMWARE UPDATES VIA EG4® ELECTRONICS APP.....	55
14.2	FIRMWARE UPDATE VIA MONITOR CENTER (WEBSITE).....	56
15.	TROUBLESHOOTING AND MAINTENANCE.....	56
15.1	REGULAR MAINTENANCE.....	56
15.2	LED DESCRIPTION.....	57
15.3	FAULTS AND ALARMS LIST.....	57
16.	STANDARDS AND CERTIFICATIONS.....	60
17.	WARRANTY INFORMATION.....	60
18.	CHANGELOG.....	61

1. TECHNICAL SPECIFICATIONS

INVERTER	
MODEL	IV-16000-HYB-AW-FX-XX
CEC MODEL #	IV-16000-HYB-AW-FX-XX {240V} IV-16000-HYB-AW-FX-XX {208V}
TYPE	Hybrid
DESIGN TOPOLOGY	High Frequency – Transformerless
AC SYSTEM	
NOMINAL VOLTAGE	120/240 or 208 VAC
FREQUENCY	50/60Hz
PHASE SUPPORT	1ø
AC OUT	
NOMINAL OUTPUT VOLTAGE	120/240 VAC; 120/208 VAC (L1/L2/N required)
MAX. CONTINUOUS OUTPUT	66.7A 16kW
MAX. CONTINUOUS OUTPUT – BATTERY ONLY	50A 12kW
MAX. CONTINUOUS OUTPUT – WITH PV & GRID @25C	66.7A 16kW
PEAK POWER	24000W (.5 sec) 18000W (1 sec) 15000W (6 min) 13200W (12 min)
LOCKED ROTOR AMPS (LRA)	195A
MAX. CONTINUOUS OUTPUT PER-LEG	50A 6kW
POWER FACTOR	.99 @ Full Load
MAX. PASS-THRU CURRENT FROM GRID	90A
REACTIVE POWER ADJUST RANGE	+0.8/-0.8
THD V	<5%
MAX. APPARENT POWER WITH BATTERY	12kVA
MAX. APPARENT POWER WITH PV & GRID	16kVA
AC IN	
NOMINAL GRID VOLTAGE	120/240 VAC 120/208 VAC (L1/L2/N required)
MAX. GRID INPUT POWER TO INVERTER (W/ OUT PASS-THRU)	50A 12kW
MAX. GRID CIRCUIT RATING (W/ PASS-THRU)	90A
MAX. INPUT SHORT CIRCUIT CURRENT RATING	10kA
BATTERY	
NOMINAL VOLTAGE	51.2 VDC
OPERATING VOLTAGE RANGE	40 – 60 VDC
MAX. CHARGE CURRENT (DC AMPS)	250 ADC
MAX. DISCHARGE CURRENT (DC AMPS)	250 ADC
COMPATIBLE BATTERIES	See www.eg4electronics.com
RECOMMENDED MIN. CAPACITY PER INVERTER	600Ah

PV DC IN	
# OF MPPTS	3
RATED CURRENT PER MPPT	26A (MPPT 1) 26A (MPPT 2) 15A (MPPT 3)
INPUTS PER MPPT	3 2 (MPPT 1) 2 (MPPT 2) 1 (MPPT 3)
SHORT-CIRCUIT CURRENT RATING PER MPPT	31A (MPPT 1) 31A (MPPT 2) 19A (MPPT 3)
MAX. DC INPUT VOLTAGE	600 VDC*
MPPT DC STARTUP VOLTAGE	200 VDC
MPPT FULL POWER VOLTAGE RANGE	250 – 440 VDC**
MPPT DC OPERATING VOLTAGE RANGE	120 – 440 VDC
MPPT VOLTAGE HIGH PROTECTION	550 VDC***
RECOMMENDED MAX. SOLAR ARRAY POWER (STC)	21kW
RESPONSE	
TRANSFER TIME (GRID TO BATTERY SWITCHING TIME)	20ms (Default), 10ms (Configurable)
OPEN LOOP RESPONSE TIME (OLRT)	<2 sec
TIME TO STEADY STATE	<10 sec
EFFICIENCY	
CEC WEIGHTED EFFICIENCY	97%
MAX. EFFICIENCY: PV TO GRID/LOAD	97%
MAX. EFFICIENCY: BATTERY TO GRID/LOAD	94%
MAX. EFFICIENCY: PV TO BATTERY	94.5%
MAX. EFFICIENCY: AC TO BATTERY	94%
IDLE CONSUMPTION (STANDBY MODE)	<65W @25C
CONTROL & MONITORING	
DISPLAY	Optional EG4 FlexBOSS Screen Kit
USER INTERFACE	App/Web
REMOTE CONNECTIVITY	Wi-Fi, Cellular, and Ethernet (Wi-Fi dongle included by default)
ENVIRONMENTAL	
OPERATING TEMPERATURE RANGE	-13° – 140°F (-25° – 60°C)
STORAGE TEMPERATURE RANGE	-13° – 140°F (-25° – 60°C)
OPERATING HUMIDITY	0 – 95% relative humidity
OPERATING ALTITUDE	<6561 ft. (<2000 m)****
ENCLOSURE RATING	NEMA 4X
COOLING METHOD	Fans
NOISE	<50dB @ 3 ft.

*Do not exceed the max. DC input voltage specification of 600 VDC. Any damage caused by reaching >600 VDC will not be covered under warranty.

**When sizing the system, it is best practice to follow the MPPT Full Power Voltage Range specifications, and not the maximum voltage of the MPPT.

***The value at which the inverter will fault to protect the MPPT from the overvoltage spec of 600 VDC. Ensure geographical considerations, weather patterns, and panel specifications are factored into string sizing.

See <https://eg4electronics.com/wp-content/themes/hello-elementor/eg4-solar-panel-string-sizer/> for the EG4® string sizing tool.

****For installations above 2000 m, the inverter needs to be derated to specific values depending on the elevation. Refer to the “Inverter Altitude and Derating Usage Restrictions” guide by navigating to <https://eg4electronics.com/wp-content/uploads/2026/04/EG4-Inverter-Altitude-Derating-Usage-Restrictions.pdf> or by scanning the QR code below.



PHYSICAL SPECIFICATIONS

DIMENSIONS (H × W × D)	30.43 × 22.28 × 11.22 in. (773 × 566 × 285 mm)
UNIT WEIGHT	121 lbs. (55 kg)
MOUNTING	Wall mount
MAX # OF INVERTERS IN PARALLEL	16

COMPLIANCE AND SAFETY

CERTIFICATIONS	UL1741, SA, SB, PCS CRD California Rule 21 Phase I, II, III CSA 22.2.107.1:2016 Ed. 4 CSA 22.2.330:2017 Ed. 1 IEEE 1547.1:2020; IEEE 1547:2018 Hawaii Rule 14H [HECO SRD IEEE 1547.1-2020 Ed.2]
----------------	---

EMISSIONS	FCC Part 15, Class B
-----------	----------------------

WARRANTY*	10 years
-----------	----------

SAFETY	Integrated DC disconnect, Reverse polarity protection, Output overvoltage protection varistor, Output over current protection, Ground fault monitoring, Grid monitoring, Pole sensitive leakage current monitoring unit, AFCI, RSD Arc-Fault Circuit Interrupter (AFCI) NEC 2020:690.11/UL1699B Ground Fault Monitoring (GFDI) NEC 2020:690.41(B) Rapid Shutdown (RSD) NEC 2020:690.12
--------	--

PROTECTIONS

BREAKER RATINGS

BATTERY BREAKER	300A
-----------------	------

*For information regarding warranty registration on EG4® Electronics products, please navigate to <https://eg4electronics.com/warranty/> and select the corresponding product to begin the registration process.

2. ABBREVIATIONS

- AWG – American Wire Gauge
- A – Amps
- Ah – Amp hour(s)
- AC – Alternating Current
- AFCI – Arc-Fault Circuit Interrupter
- AHJ – Authority Having Jurisdiction
- kAIC – kilo-Amp Interrupting Capability
- ANSI – American National Standards Institute
- BAT – Battery
- BMS – Battery Management System
- COM – Communication
- CT – Current Transformer
- DC – Direct Current
- DIP – Dual In-line Package
- DOD – Depth of Discharge
- EG – Equipment Ground
- EGS – Equipment Grounding System
- EMC – Electromagnetic Compatibility
- EPS – Emergency Power System
- ESS – Energy Storage System
- E-Stop – Emergency Stop
- FCC – Federal Communication Commission
- GE – Grounding Electrode
- GEC – Grounding Electrode Conductor
- GFCI – Ground Fault Circuit Interrupter
- GFDI – Ground Fault Detector/Interrupter
- Imp – Maximum Power Point Current
- IEEE – Institute of Electrical and Electronic Engineers
- IP – Ingress Protection
- I_{sc} – Short-Circuit Current
- In-lbs. – Inch Pounds
- kW – Kilowatt
- kWh – Kilowatt-hour
- LCD – Liquid Crystal Display
- LFP – Lithium Iron Phosphate
- L1 – Line 1
- L2 – Line 2
- mm – Millimeters
- MPPT – Maximum Power Point Tracking
- mV – Millivolt
- N – Neutral
- NEC – National Electric Code
- NEMA – National Electrical Manufacturers Association
- NFPA – National Fire Prevention Association
- Nm – Newton Meters
- NOCT – Normal Operating Cell Temperature
- PC – Personal Computer
- PCB – Printed Circuit Board
- PE – Protective Earth
- PPE – Personal Protective Equipment
- PV – Photovoltaic
- RSD – Rapid Shut Down
- SCC – Standards Council of Canada
- SOC – State of Charge
- STC – Standard Testing Conditions
- UL – Underwriters Laboratories
- UPS – Uninterrupted Power Supply
- V – Volts
- VOC – Open-Circuit Voltage
- VMP – Voltage Maximum Power

3. INVERTER SAFETY

3.1 SAFETY INSTRUCTIONS

International safety regulations have been strictly observed in the design and testing of the inverter. Before beginning any work, carefully read all safety instructions, and always observe them when working on or with the inverter. The installation must follow all applicable national or local standards and regulations.

Incorrect installation may cause:

- Injury or death to the installer, operator or third party
- Damage to the inverter or other attached equipment

3.2 IMPORTANT SAFETY NOTIFICATIONS



DANGER!

Hazardous Voltage Circuits!

There are various safety concerns that must be carefully observed before, during, and after the installation, as well as during future operation and maintenance. The following are important safety notifications for the installer and any end users of this product under normal operating conditions.

1. **Beware of high PV voltage.** Install an external DC disconnect switch or breaker and ensure it is in the “off” or “open” position before installing or working on the inverter. Use a voltmeter to confirm there is no DC voltage present to avoid electric shock.
2. **Beware of high grid voltage.** Ensure the AC switch and/or AC breaker are in the “off” or “open” position before installing or working on the inverter. Use a voltmeter to confirm there is no voltage present to avoid electric shock.
3. **Beware of high battery current.** Ensure that the battery module breakers and/or on/off switches are in the “open” or “off” position before installing or working on the inverter. Use a voltmeter to confirm there is no DC voltage present to avoid electric shock.
4. **Do not open the inverter while it is operating to avoid electric shock and damage from live voltage and current within the system.**
5. Do not make any connections or disconnections (PV, battery, grid, communication, etc.) while the inverter is operating.
6. An installer should make sure to be well protected by reasonable and professional insulative equipment [e.g., personal protective equipment (PPE)].
7. Before installing, operating, or maintaining the system, it is important to inspect all existing wiring to ensure that it meets the appropriate specifications and conditions for use.
8. Ensure that the PV, battery, and grid connections to the inverter are secure and proper to prevent damage or injuries caused by improper installation.
9. Some components of the system can be very heavy. Be sure to utilize team-lift among other safe lifting techniques throughout the installation.



WARNING: TO REDUCE THE RISK OF INJURY, READ ALL INSTRUCTIONS!

All work on this product (system design, installation, operation, setting, configuration, and maintenance) must be carried out by qualified personnel. To reduce the risk of electric shock, do not perform any servicing other than those specified in the operating instructions unless qualified to do so.

1. Read all instructions before installing. For electrical work, follow all local and national wiring standards, regulations, and these installation instructions.
2. Make sure the inverter is properly grounded. All wiring should be in accordance with the National Electrical Code (NEC), ANSI/NFPA 70.
3. The inverter and system can inter-connect with the utility grid only if the utility provider permits. Consult with the local AHJ (Authority Having Jurisdiction) before installing this product for any additional regulations and requirements for the immediate area.
4. All warning labels and nameplates on the inverter should be clearly visible and must not be removed or covered.
5. The installer should consider the safety of future users when choosing the inverter's correct position and location as specified in this manual.
6. Keep children from touching or misusing the inverter and relevant systems.
7. **Beware!** The inverter and some parts of the system can be hot when in use. Do not touch the inverter's surface or most of the parts when they are operating. During operation, only the LCD and buttons should be touched.



WARNING!

Cancer and Reproductive Harm – See www.P65Warnings.ca.gov for more details.

DISCLAIMER

EG4® reserves the right to make changes to the material herein at any time without notice.

Please refer to www.eg4electronics.com for the most updated version of our manuals/spec sheets.

4. SÉCURITÉ DE L'ONDULEUR

4.1 INSTRUCTIONS DE SÉCURITÉ

Les réglementations internationales de sécurité ont été strictement observées lors de la conception et des tests de l'onduleur. Avant de commencer tout travail, lisez attentivement toutes les instructions de sécurité et respectez-les toujours lorsque vous travaillez sur ou avec l'onduleur. L'installation doit suivre toutes les normes et réglementations nationales ou locales applicables. Consultez l'autorité locale compétente et/ou le fournisseur d'électricité pour obtenir les permis et autorisations nécessaires avant l'installation.

Une installation incorrecte peut causer:

- Des blessures ou la mort de l'installateur, de l'opérateur ou d'un tiers
- Des dommages à l'onduleur ou à d'autres équipements connectés

4.2 NOTIFICATIONS DE SÉCURITÉ IMPORTANTES



DANGER: *Circuits à haute tension!*

Il y a divers problèmes de sécurité qui doivent être soigneusement observés avant, pendant et après l'installation, ainsi que pendant l'exploitation et la maintenance futures. Les notifications de sécurité suivantes sont importantes pour l'installateur et tout utilisateur final de ce produit dans des conditions normales de fonctionnement.

1. **Attention à la haute tension PV.** Installez un interrupteur ou disjoncteur externe de déconnexion DC et assurez-vous qu'il est en position "off" ou "ouvert" avant d'installer ou de travailler sur l'onduleur. Utilisez un voltmètre pour confirmer qu'il n'y a pas de tension DC présente afin d'éviter les chocs électriques.
2. **Attention à la haute tension du réseau.** Assurez-vous que l'interrupteur AC et/ou le disjoncteur AC sont en position "off" ou "ouvert" avant d'installer ou de travailler sur l'onduleur. Utilisez un voltmètre pour confirmer qu'il n'y a pas de tension présente afin d'éviter les chocs électriques.
3. **Attention au courant élevé de la batterie.** Assurez-vous que les disjoncteurs des modules de batterie et/ou les interrupteurs on/off sont en position "ouvert" ou "off" avant d'installer ou de travailler sur l'onduleur. Utilisez un voltmètre pour confirmer qu'il n'y a pas de tension DC présente afin d'éviter les chocs électriques.
4. **Ne pas ouvrir l'onduleur pendant qu'il fonctionne pour éviter les chocs électriques et les dommages dus à la tension et au courant en direct dans le système.**
5. Ne pas effectuer de connexions ou de déconnexions (PV, batterie, réseau, communication, etc.) pendant que l'onduleur fonctionne.
6. Un installateur doit s'assurer d'être bien protégé par un équipement isolant raisonnable et professionnel (par exemple, équipement de protection individuelle (EPI)).
7. Avant d'installer, d'exploiter ou de maintenir le système, il est important d'inspecter tous les câblages existants pour s'assurer qu'ils répondent aux spécifications et conditions appropriées pour l'utilisation.
8. Assurez-vous que les connexions PV, batterie et réseau à l'onduleur sont sécurisées et appropriées pour éviter les dommages ou les blessures causés par une installation incorrecte.
9. Certains composants du système peuvent être très lourds. Assurez-vous d'utiliser des techniques de levage en équipe parmi d'autres techniques de levage sûres tout au long de l'installation.



AVERTISSEMENT : POUR RÉDUIRE LE RISQUE DE BLESSURE, LISEZ TOUTES LES INSTRUCTIONS !

Tous les travaux sur ce produit (conception du système, installation, exploitation, réglage, configuration et maintenance) doivent être effectués par du personnel qualifié. Pour réduire le risque de choc électrique, ne réalisez aucun entretien autre que ceux spécifiés dans les instructions de fonctionnement, sauf si vous êtes qualifié pour le faire.

1. Lisez toutes les instructions avant d'installer. Pour les travaux électriques, suivez toutes les normes et réglementations locales et nationales de câblage, ainsi que ces instructions d'installation.
2. Assurez-vous que l'onduleur est correctement mis à la terre. Tous les câblages doivent être conformes au Code National de l'Électricité (NEC), ANSI/NFPA 70.
3. L'onduleur et le système peuvent se connecter au réseau électrique uniquement si le fournisseur d'électricité le permet. Consultez l'autorité locale compétente avant d'installer ce produit pour toute réglementation et exigence supplémentaire pour la zone immédiate.
4. Toutes les étiquettes d'avertissement et les plaques signalétiques sur l'onduleur doivent être clairement visibles et ne doivent pas être retirées ou couvertes.
5. L'installateur doit tenir compte de la sécurité des futurs utilisateurs lors du choix de la position et de l'emplacement corrects de l'onduleur, comme spécifié dans ce manuel.
6. Empêchez les enfants de toucher ou de mal utiliser l'onduleur et les systèmes pertinents.
7. **Attention !** L'onduleur et certaines parties du système peuvent être chauds lorsqu'ils sont utilisés. Ne touchez pas la surface de l'onduleur ou la plupart des pièces lorsqu'elles fonctionnent. Pendant le fonctionnement, seuls l'écran LCD et les boutons doivent être touchés.



AVERTISSEMENT !

Cancer et dommages reproductifs – Voir www.P65Warnings.ca.gov pour plus de détails.

DISCLAIMER

EG4® se réserve le droit de modifier le contenu de ce document à tout moment sans préavis. Veuillez consulter www.eg4electronics.com pour la version la plus récente de nos manuels/fiches techniques.

5. PRODUCT OVERVIEW

The EG4® FlexBOSS21 is a 16kW, 120/240 VAC split-phase, all-in-one, hybrid, sine wave inverter designed for the residential and small commercial markets. The FlexBOSS21 can utilize 21kW of DC (STC) solar PV on three MPPTs (26/26/15A) and can generate 12kW of power during non-peak sunlight conditions and 16kW with solar PV gain when connected to the grid. It can bypass 90A of utility power from its grid port to load port. The FlexBOSS21 is an enhanced power-level cousin to EG4's flagship 18kPV inverter. Though it can perform as a standalone inverter, it has been designed to work optimally with EG4's GridBOSS power gateway. This unique pairing unlocks an even more robust feature-set and level of performance for the end user.

5.1 PACKING LIST

When the product is unpacked, the contents should match the list below.

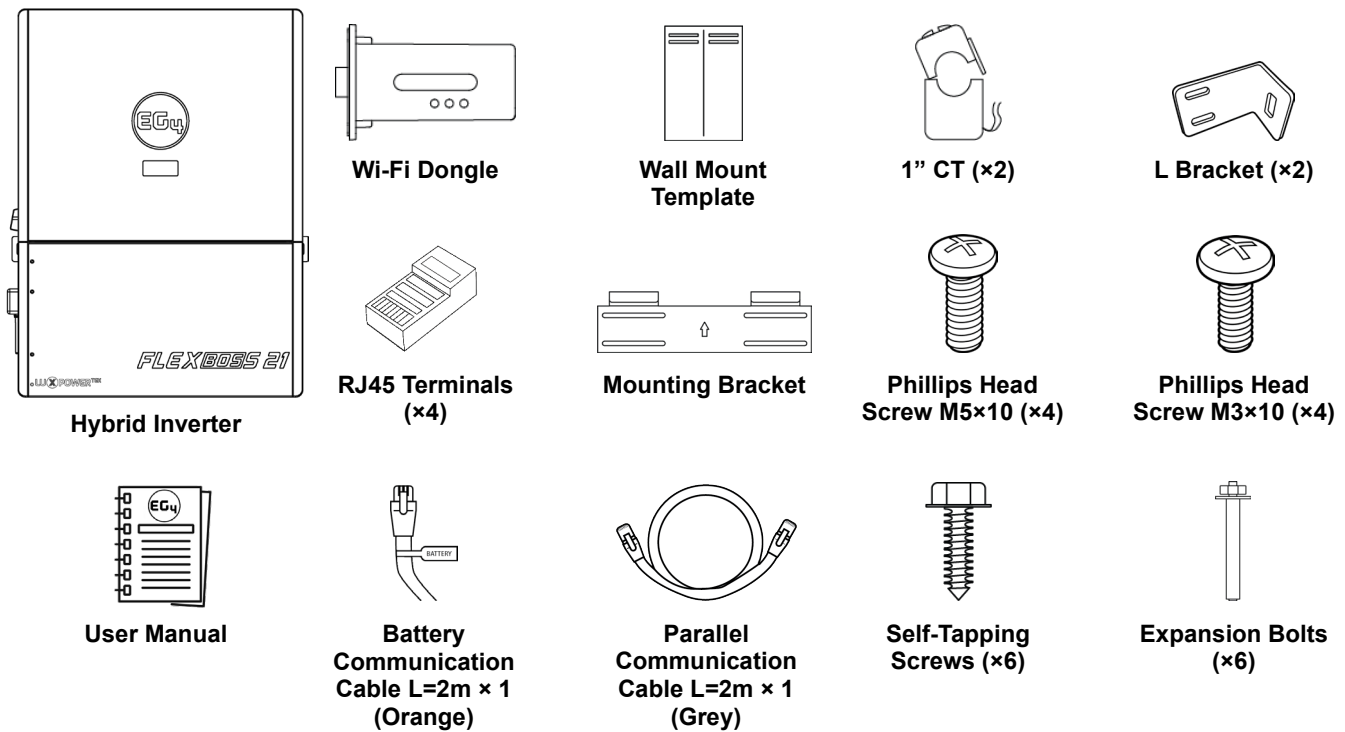

Pictures for reference only.

5.2 FEATURES OVERVIEW

- FlexBOSS21 is a split-phase hybrid inverter that has the ability to operate off and on the grid.
- Designed for rural and suburban homeowners, and small commercial companies seeking energy savings and independence.
- Charge batteries and power loads simultaneously as users harness multiple power sources, including photovoltaic (PV), battery storage, as well as the grid.
- Supports up to 25kW of DC (STC) solar PV input while producing 16kW of continuous AC output (with PV), even during battery charging, positioning it as an effective option for those looking to implement a robust Energy Storage System (ESS).
- Incorporates MPPTs, a bi-directional DC-AC inverter, grid interaction, and battery connectivity. Supports closed-loop communications with all EG4[®] batteries and a wide selection of third-party batteries using CAN/RS485 protocols.
- Three MPPT solar charge controllers support a PV input of 600V with an optimal range of 250 – 440 VDC. The three MPPTs allow for flexibility in paralleling strings. MPPT 1 and 2 allow up to 26A each, while MPPT 3 allows 15A, for a total of 21kW of utilized solar power.
- Rated for 12kW continuous output without PV, and 16kW continuous output when utilizing PV and grid connection, with a power factor of 1.
- Features a comprehensive list of certifications that ensure code compliance while offering additional safety and reliability. Fully compliant safety features include PV Arc Fault Protection, PV Ground Fault Protection, PV Reverse Polarity Protection, Pole Sensitive Leakage Current Monitoring Unit, Surge Protection, Integrated PV Disconnect, built-in RSD transmitter, and RSD/ESS disconnect initiator.
- Modular design allows for expansion, adapting to growing energy needs and securing future efficiency in solar investment. Supports up to 16 inverters in a parallel configuration.
- Users can monitor system performance and perform updates remotely via the EG4[®] Monitoring website and mobile app, ensuring control and flexibility.
- Full AC coupling, generator, and smart loads capabilities when used with GridBOSS.

5.3 PRODUCT FEATURE IDENTIFICATION

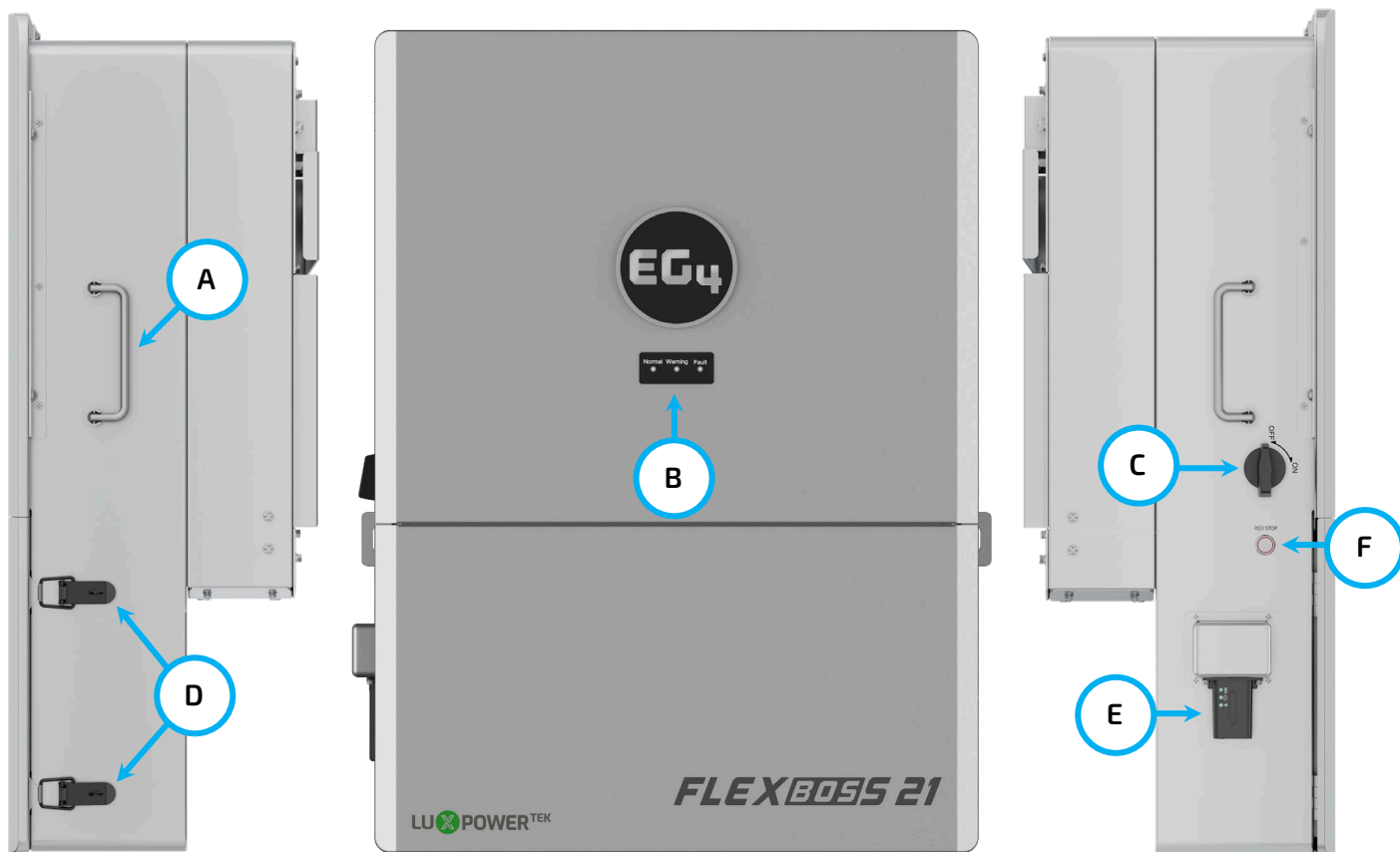

LABEL	COMPONENT	DESCRIPTION
A	Handles	Use for installation.
B	LED Panel	Used to quickly monitor system status.
C	PV Disconnect Switch	Used to connect and disconnect power from solar panels.
D	Clasps	Use to open cable box.
E	Wi-Fi Dongle	Used to communicate with Monitor Center app or website.
F	RSD Button	Rapid Shut Down.

Cable Box Overview

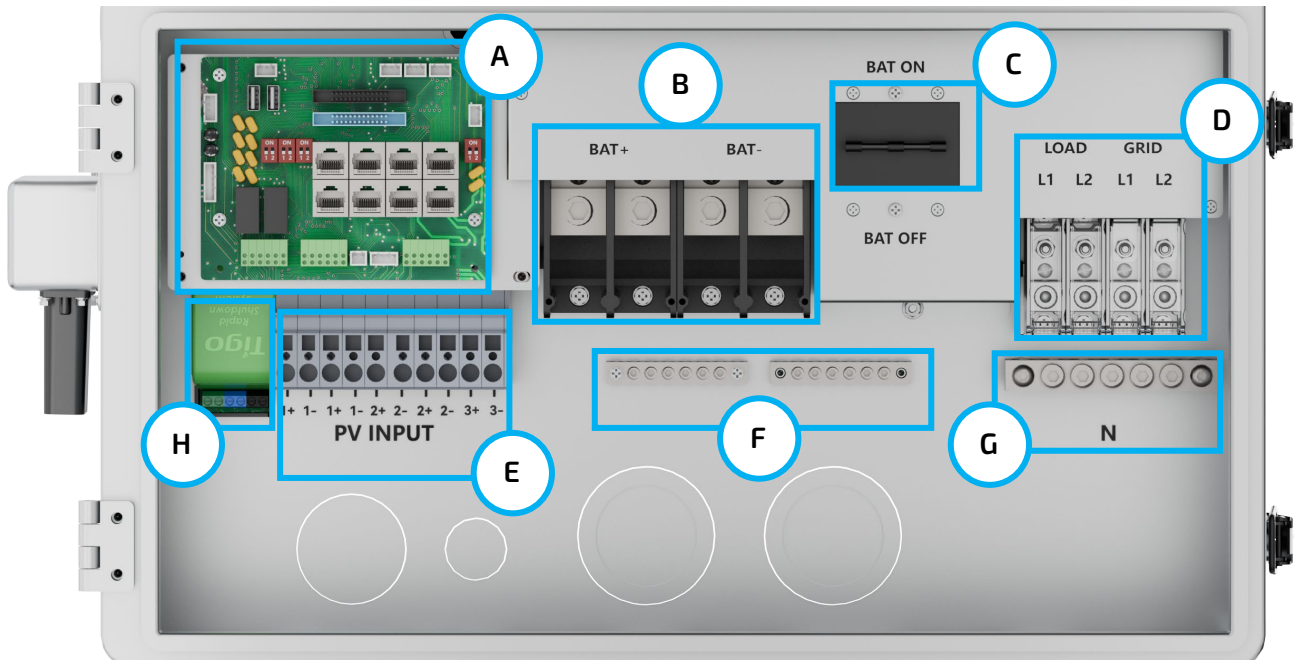

LABEL	COMPONENT	DESCRIPTION
A	Communication Board	Used to connect communications cables, set DIP switches, add CTs, and connect external RSD
B	Battery (DC) Connections	Used to connect battery cables
C	Integrated Bonded Battery Breaker	Overcurrent protection for connected batteries
D	AC Connections	Used for wiring AC power from the grid to the loads
E	PV Input	Used for wiring DC power from solar units to the inverter
F	Protected Earth (Ground Busbar)	Used for ground wiring
G	Neutral Busbar	Used for neutral wiring
H	TIGO RSD	Used for PV Rapid Shutdown

Communication Board Overview

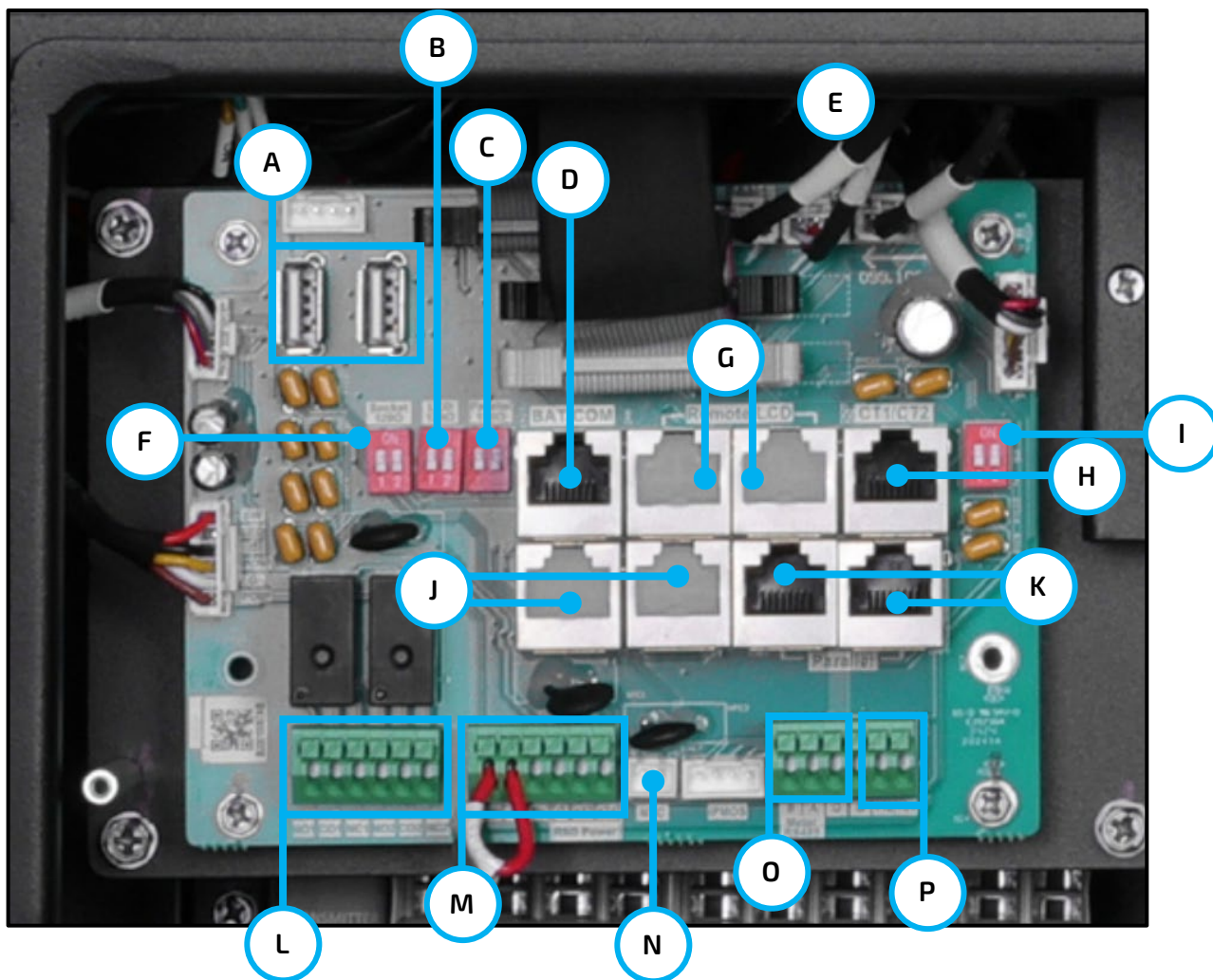

LABEL	DESCRIPTION
A	Reserved
B	Reserved
C	Parallel DIP Switches: Set DIP switches when using inverters in parallel
D	Battery Communication Port (CAN & RS485)
E	Fan Power Supply
F	485 balance resistance
G	Reserved
H	CT Interface
I	Reserved
J	Reserved
K	Paralleling Communication Port
L	DRY (NO, NC): Reserved
M	RSD Terminals
N	NTC: Connection for temperature sensor for lead-acid battery
O	Meter 485B & 485A: For meter communication
P	DC power for customer use, max. 1A

5.4 PRODUCT DIMENSIONS

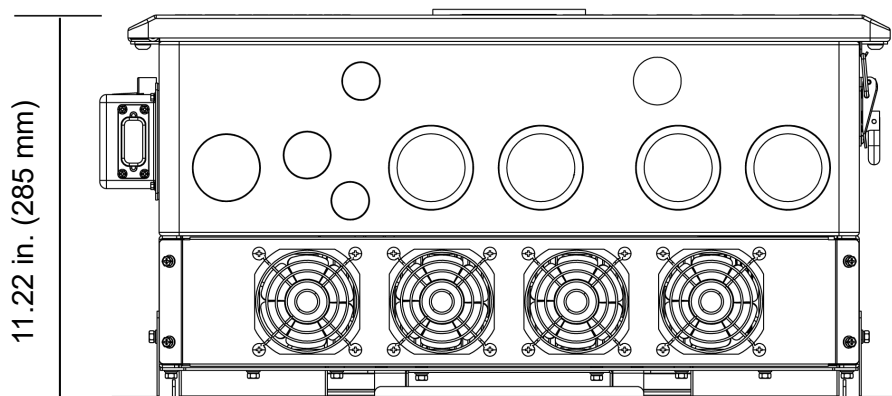
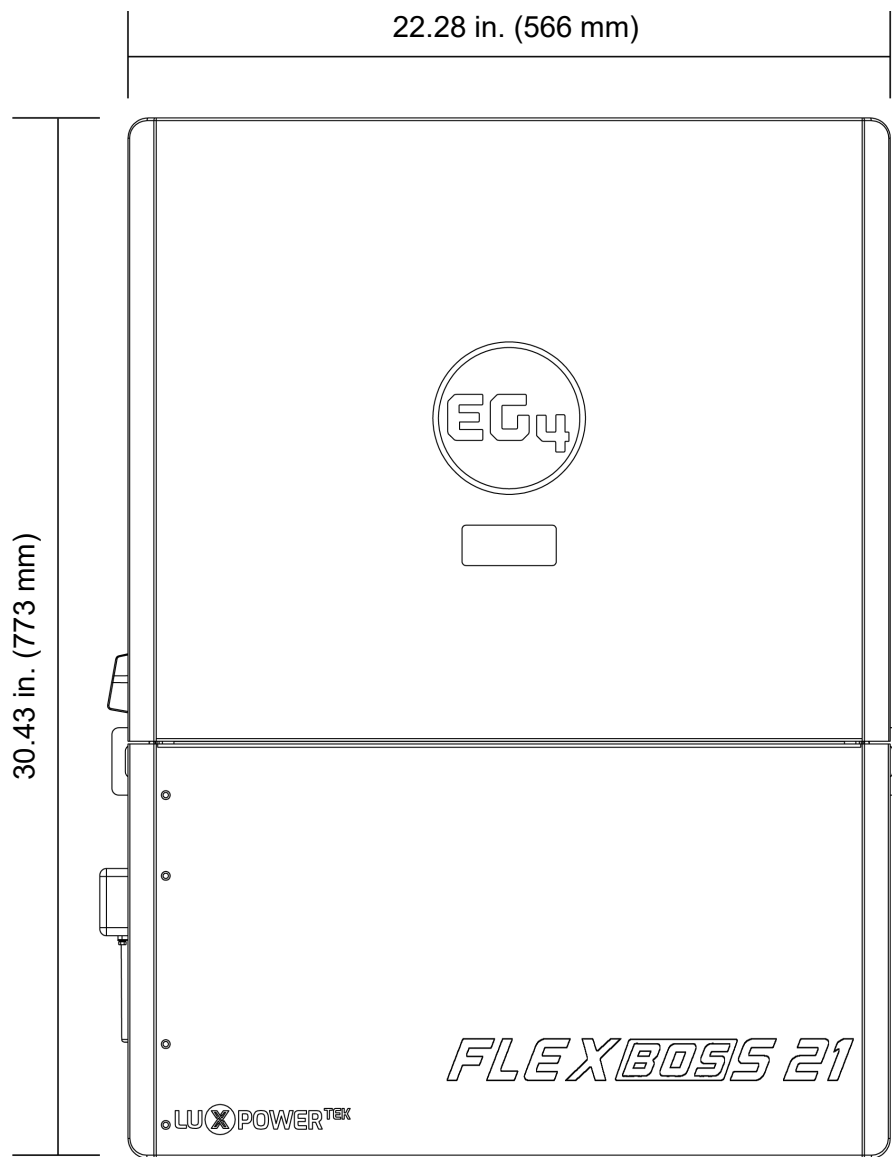

Bottom View of Cable Box Knockouts

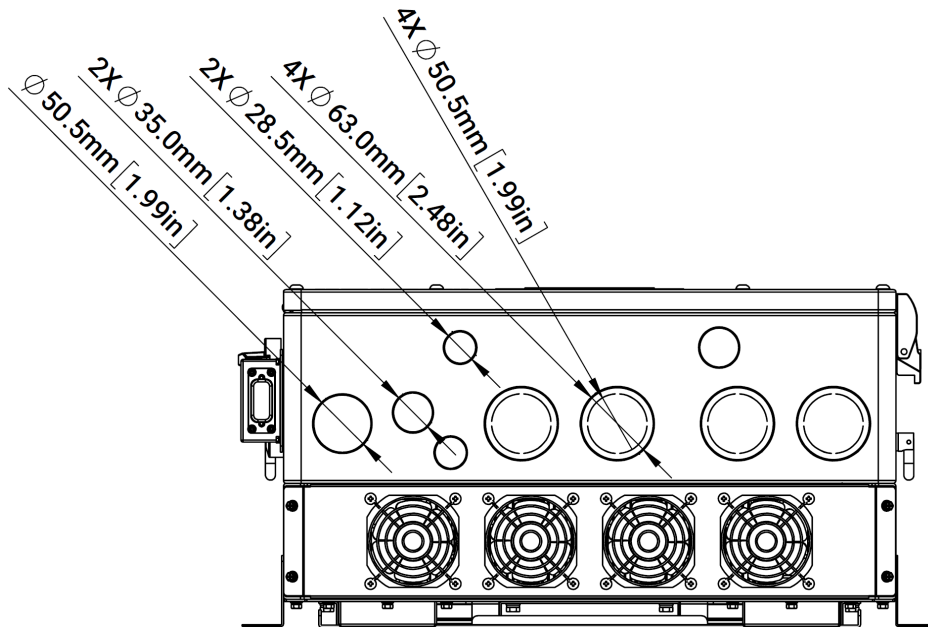

Back View of Cable Box Knockouts

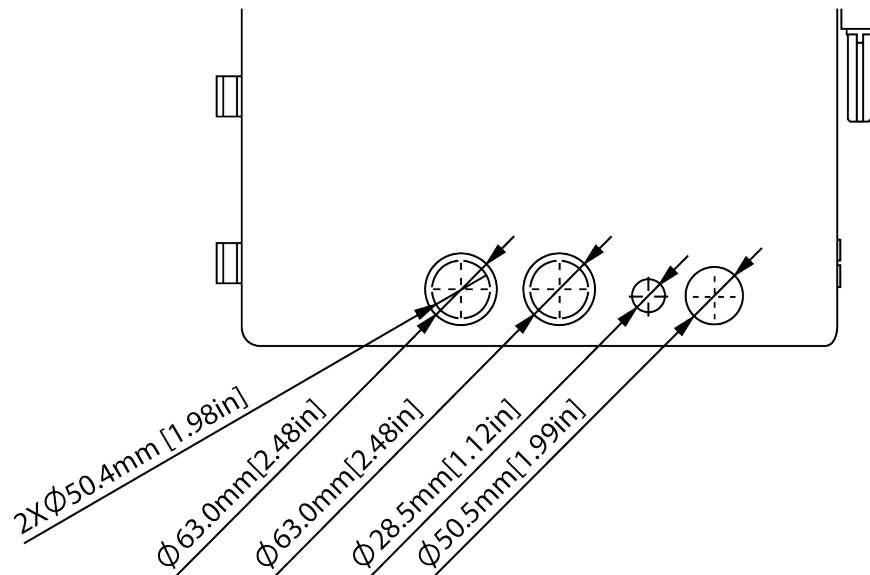

U.S. NOM. TRADE SIZE	ACTUAL KNOCKOUT SIZE
1/2 in.	0.88 in. (22.2 mm)
3/4 in.	1.12 in. (28.5 mm)
1 in.	1.38 in. (35 mm)
1 1/4 in.	1.73 in. (44 mm)
1 1/2 in.	1.99 in. (50.5 mm)
2 in.	2.48 in. (63 mm)

5.5 SYSTEM DIAGRAMS

This unit and its associated system are suitable for the following applications:

FlexBOSS21 ESS System Configurations

WITHOUT GRIDBOSS

Grid-Tie w Battery Backup (GTBB)

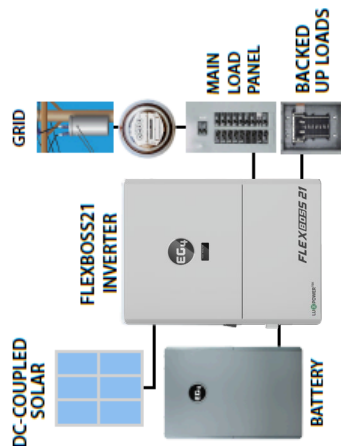

- Modest system for infrequent outages & partial home backup

WITH GRIDBOSS

Minimize or Optimize Net Energy Metering

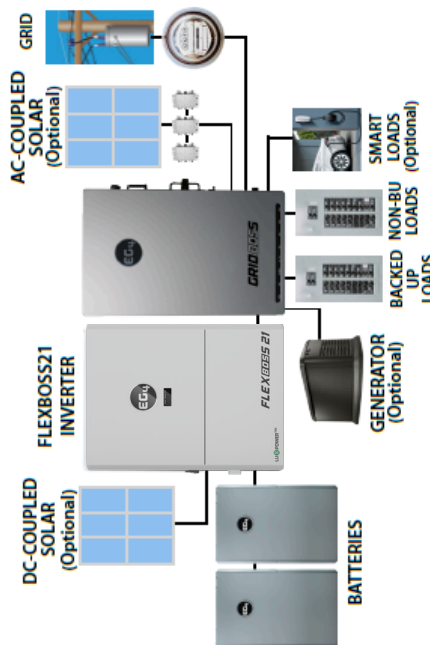

Fully Off-Grid



- Remote - No Grid
- Grid Expensive
- Add Grid Backup Later
- Self-Reliance
- Energy Autonomy
- Add Generator Power Using Subpanel

Larger Systems Using Multiple Inverters

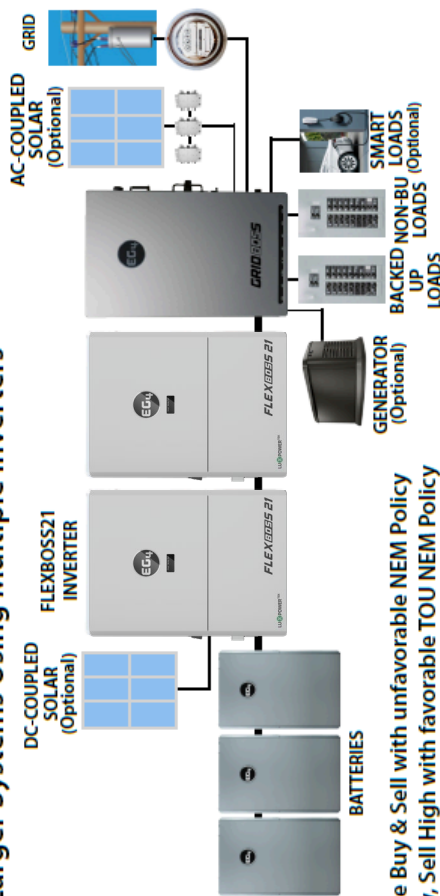

- Minimize Buy & Sell with unfavorable NEM Policy
- Buy Low, Sell High with favorable TOU NEM Policy
- Reduce Demand Charges
- Smart Loads allow for Whole-Home Backup
- Off-Grid Capable

6. STORING THE INVERTER

If placing the inverter into storage before installation, keep the following factors in mind while selecting a storage location:



CAUTION:

- *The inverter and its components must be stored in its original packaging.*
- *The storage temperature should be within -13 – 140°F (-25 – 60°C) with humidity between 0 – 85%.*
- *The packing should remain upright with a maximum of 6 layers.*
- *Do not directly expose the inverter or its packaging to sunlight or rain and keep away from corrosive materials.*

Temperature < 140°F (60°C)

Height < 6.6 ft. (2m)

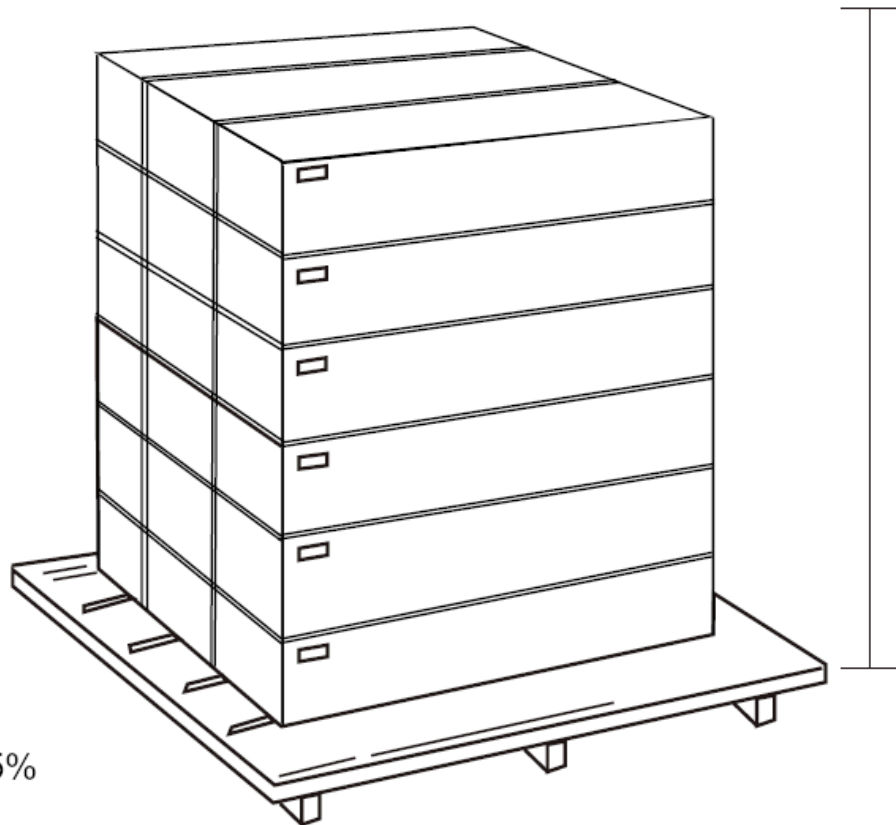

Humidity < 85%

7. SYSTEM INSTALLATION

7.1 TOOLS NEEDED FOR INSTALLATION

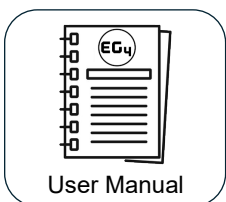
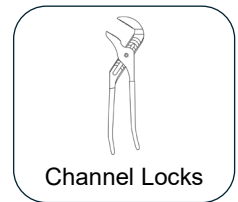
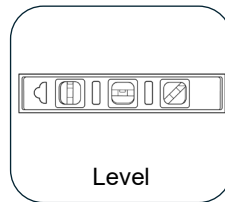
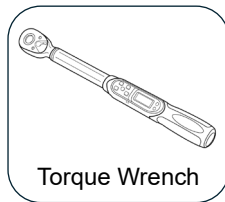
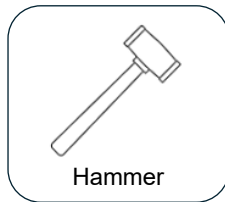
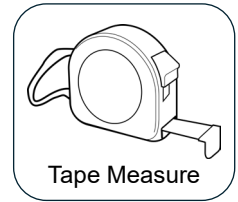
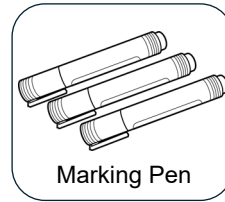
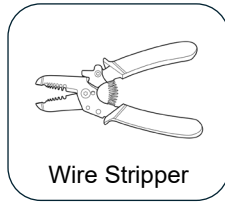
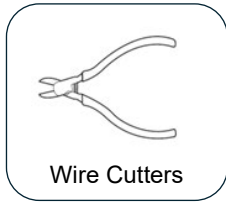
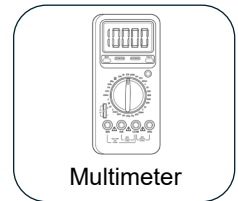

7.2 LOCATION SELECTION AND INSTALLATION

Requirements for Installation



DANGER:

Ensure there is at least 5.91 inches (150 mm) of space on the left and right side of the inverter and at least 11.81 inches (300 mm) above the unit for heat to dissipate or else there is a risk of fire. Ensure the inverter is mounted away from all combustible materials.

1. The mounting wall should be strong enough to bear the weight of the inverter.

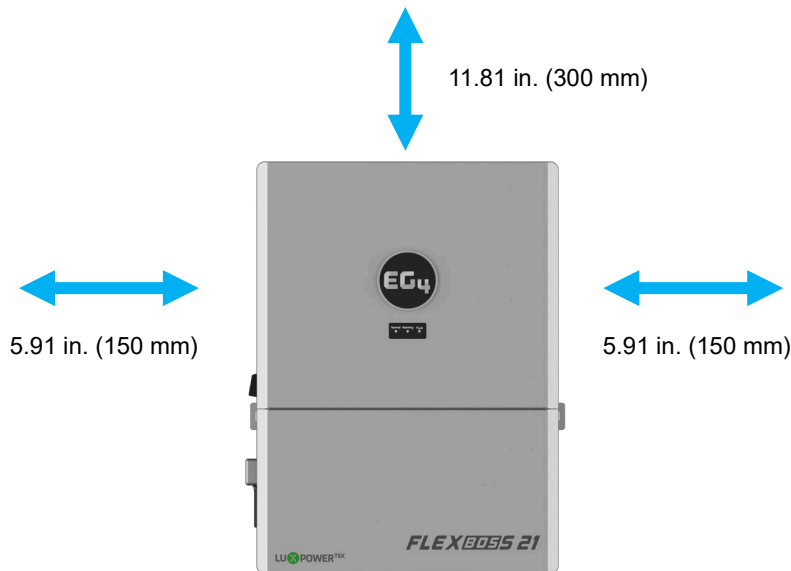

2. Maintain the minimum clearances presented below for adequate heat dissipation.
3. Avoid positioning the inverter in direct sunlight, rain, or snow. Refer to the figure below and choose a well-shaded site or in an indoor location to protect the inverter from the elements. The inverter should be installed upright on a vertical surface.

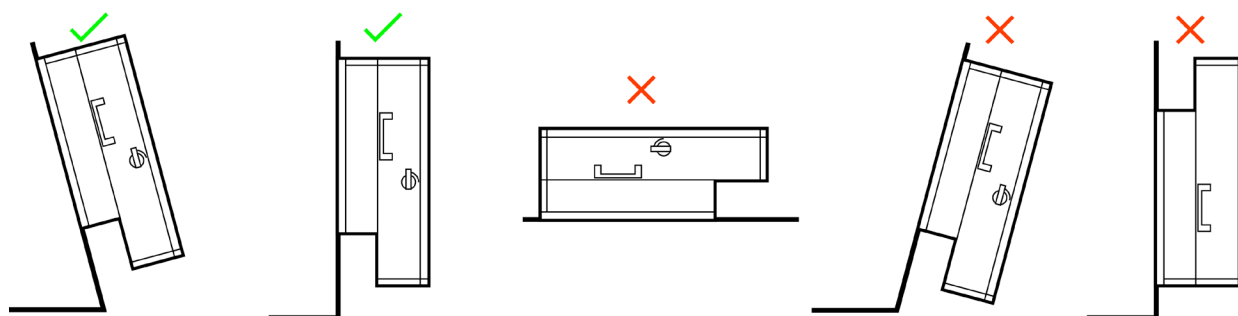
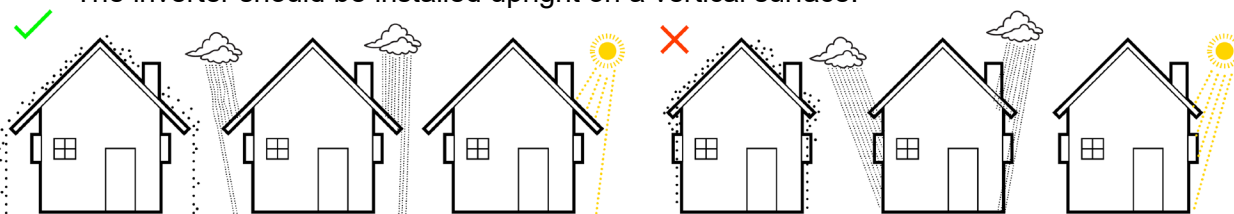

Installing the Inverter

The inverter is designed to be wall-mounted on a vertical, solid, **non-combustible** surface such as brick or concrete. Two or more people may be needed to install the inverter due to its weight. The slots on the mounting bracket can accommodate various stud spacings from 12 in. (305 mm) to 16 in. (406 mm).

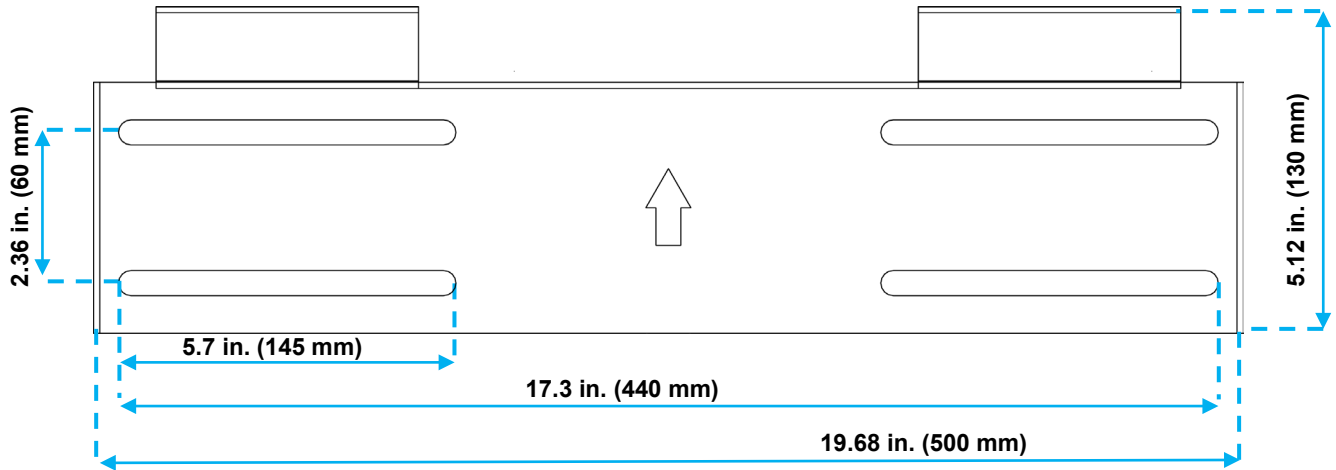

NOTE:

Ensure the mounting surface can support the weight of the unit and has proper spacing per the diagram above.

Mounting Steps

1. Select a location for the inverter's final placement.
2. Use the wall mounting template to mark where the mounting bracket screws will be installed. Use a level to ensure the bracket will be installed parallel with the ground.

NOTE: When installing the bracket to studs, verify the marks for the screws are centered over a stud. Ensure proper 12 in. (305 mm) or 16 in. (406 mm) spacing.

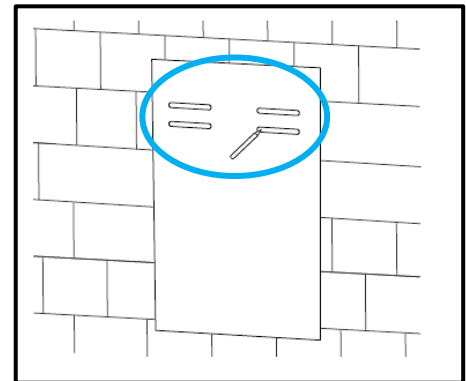

3. When installing the bracket to concrete or brick, drill 5/16 in. (8 mm) diameter holes on the marks, making sure the holes are deeper than 2 in. (50 mm) when using the included expansion bolts. When installing the bracket to studs, drill a pilot hole sized appropriately for the screw diameter used. Ensure studs are spaced 12 to 16 in. apart.

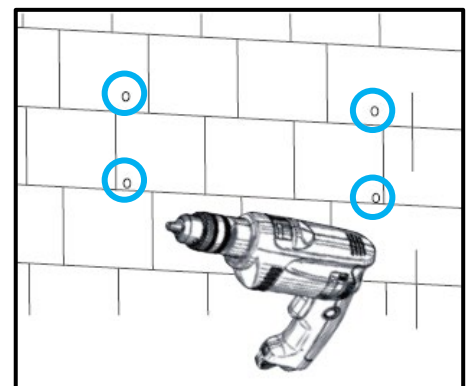

4. For concrete or brick installation, insert the expansion bolts into the drilled holes. Install the bracket to the wall, ensuring the arrow is pointing up. Use the corresponding nuts and washers (packaged together with the expansion bolts) to affix the bracket to the wall. For stud wall installation, use the proper screws and affix the bracket to the wall.

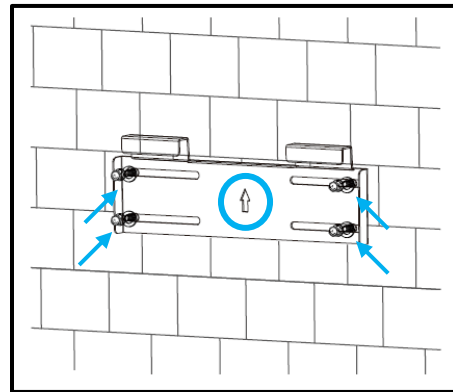

5. Using the team lift technique, place the inverter onto the wall bracket, securing it to the wall.

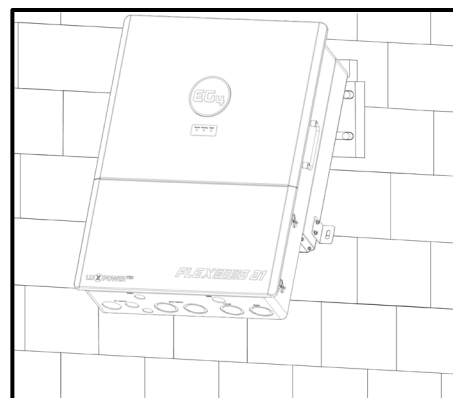

6. Temporarily mount the L bracket to the side of the inverter (located at the bottom, one on each side). Mark holes on the wall based on the hole location on the L bracket (repeat this step for both sides).

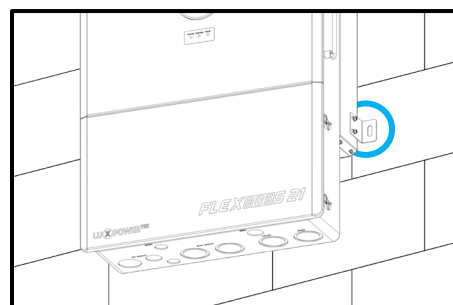

7. Remove the L bracket and drill a hole at the marking. Use the drill bit size based on the anchor type or screw size as directed in step 3 (repeat this step for both sides).

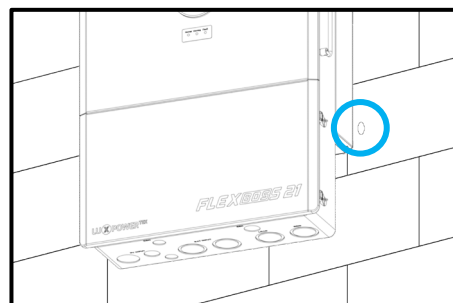

8. Attach the L brackets (one on each side) to the inverter and to the wall using the correct hardware. Once the bracket is secure, the wall installation is complete.

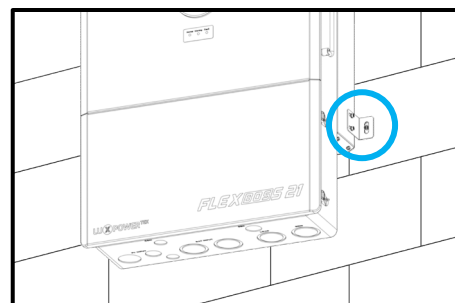

7.3 CONNECTION OVERVIEW

To expose the cable box area, open the bottom cover by opening the clasps on the side of the inverter and remove the three screws on the internal wire box cover as indicated in the image below. Before connecting any wiring to the inverter, verify each wire is not carrying voltage using a multimeter.

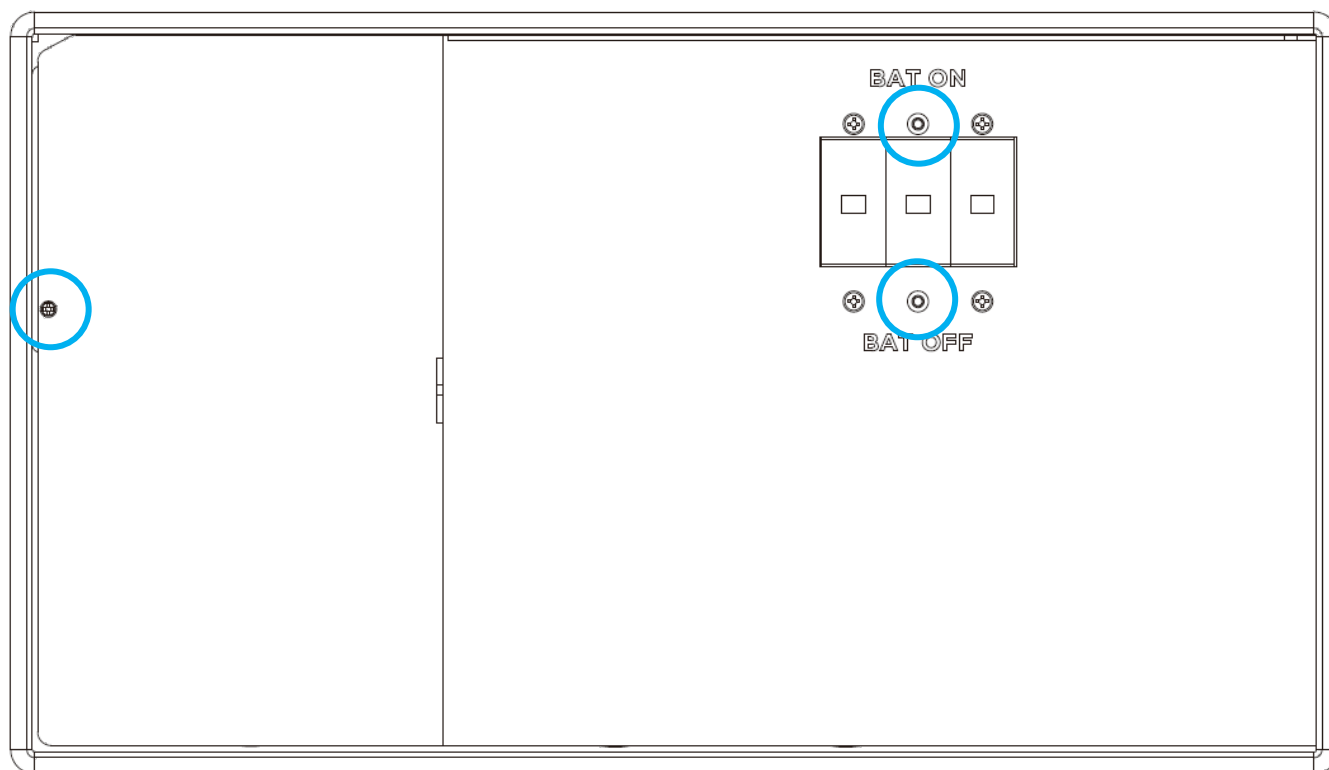

7.4 BATTERY CONNECTIONS

The FlexBOSS21 comes equipped with two battery inputs with 2 positive and 2 negative points of connection. The two positive battery terminals are protected by a 300A breaker. This is to accommodate using parallel conductors as supplied with the WallMount battery series. It is designed to utilize 4 battery cables up to 20 feet by using two sets of cables rather than resorting to larger cable sizes. For safe operation and regulation compliance, install a separate DC over-current protector or disconnect device between battery and inverter.

Cable Requirements*:

NUMBER OF CABLES PER POLE	TOTAL NUMBER OF CABLES	CABLE SIZE	TOTAL CABLE SET AMPACITY	MAX. DISTANCE	TORQUE VALUES	INTEGRATED BATTERY BREAKER
2	4	1/0 AWG (53.5mm ²)	340A	16 ft.	Max. 230 in-lbs. (26Nm)	300A
2	4	2/0 AWG (67.4mm ²)	390A	21 ft.	Max. 230 in-lbs. (26Nm)	300A
2	4	3/0 AWG (85.0mm ²)	450A	26 ft.	Max. 230 in-lbs. (26Nm)	300A
2	4	4/0 AWG (107mm ²)	520A	33 ft.	Max. 230 in-lbs. (26Nm)	300A

**Consult installer to ensure that appropriate cable size is used due to various factors such as distance, operating voltage, and amperage.*

Cable Installation:

1. Place all breakers in the OFF position before connecting or disconnecting wires. Ensure that there is no voltage present with a voltmeter.
2. Strip 3/5 in. – 4/5 in. (15 mm – 20 mm) of insulation from the cable end.
3. Route the battery power cable, connecting positive (red) to BAT +, and negative (black) to BAT -.
4. Fasten positive and negative battery cables to the mechanical terminals according to the markings with an M8 hex wrench, see torque values above.
5. Verify the positive and negative battery cables are properly connected to the battery bank and the total amp hours meet or exceed 300Ah.

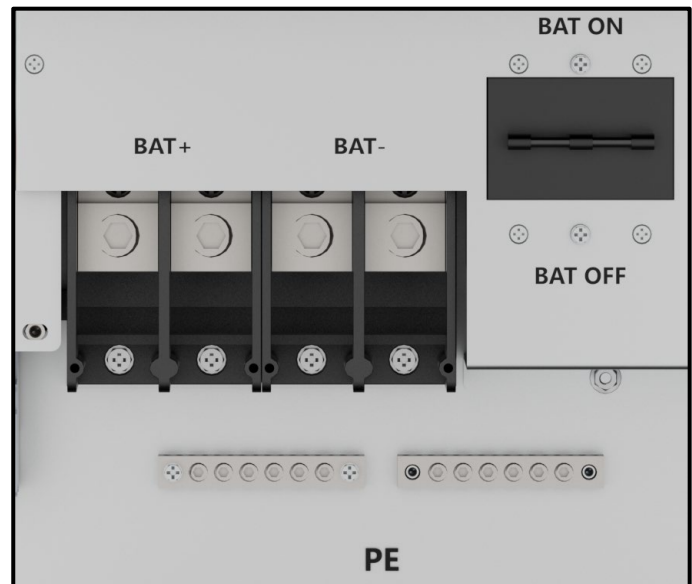

Battery Communication Cable Connections:

- Use the included orange battery communication cable to connect the battery to the inverter. Put the inverter in standby mode to protect batteries until values are set.
- The battery communication port on the inverter is an RJ45 socket with the pinout for the RJ45 plug shown below.
- The inverter supports both CAN and RS485 communication.
- After connecting the battery power and communication cables, go to the Monitor Center app or website. Select “Maintenance,” “Remote Set,” and choose battery type under “Common Settings.”
- For closed-loop communication between the inverter and lithium batteries, choose “Lithium” as the battery type. For inter-battery communication and battery setup with EG4® batteries, refer to the respective battery manual.
- Select the “Lead-Acid” setting if the battery cannot communicate with the inverter. Ensure battery settings are within the battery’s specifications to prevent damaging the battery bank.



NOTE:

If using EG4® LifePower4 batteries in the system, a firmware update may be required for closed-loop communications. Contact the distributor for this file or navigate to <https://www.eg4electronics.com/> for the most recent updates and documentation. For communication with EG4® batteries, select “Lithium” under “Battery Type” and then select “0:EG4” under “Lithium Brand”

For Lithium Batteries:

- EG4® strongly recommends using closed-loop communications between the battery bank and inverter. Ensure the lithium battery being used is compatible with the inverter by visiting [eg4electronics.com](https://www.eg4electronics.com/) for an updated list of third-party batteries capable of closed-loop communication.
- If using multiple batteries modules with the inverter, the inverter communication cable must be connected to the master battery. Check with the battery supplier for battery master and slave settings.

PIN	DESCRIPTION
1	BAT RS485B
2	BAT RS485A
3	NC
4	BAT CAN H
5	BAT CAN L
6	NC
7	NC
8	NC

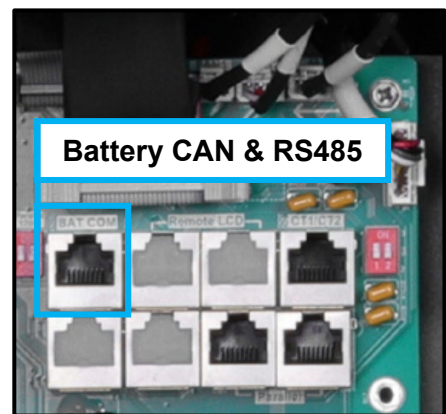
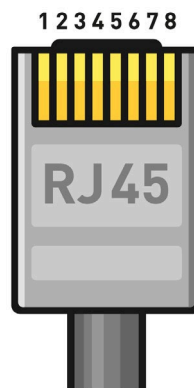

For Lead-Acid Batteries:

Closed loop communication is not available with lead-acid batteries; however, a third-party external temperature sensor will enable the inverter to control the charge/discharge of the battery. Follow the battery’s manual to determine setting parameters and for more information.

7.5 PV CONNECTIONS

Cable Requirements*:

CABLE SIZE	MINIMUM INSULATOR VOLTAGE	MAX. AMPERAGE PER MPPT
10 AWG – 6 AWG (max.) (6 mm ² – 16 mm ²)	600V	MPPT 1: 26A
		MPPT 2: 26A
		MPPT 3: 15A

*Consult installer to ensure that appropriate cable size is used due to various factors such as distance, operating voltage, and amperage.



IMPORTANT:

- Verify the lowest ambient temperature of the installation location. The rated VOC on the solar module nameplate is obtained at STC (77°F/25°C). As the ambient temperature drops, the solar module VOC increases. Ensure the maximum solar string voltage, corrected at the lowest temperature, does not exceed the inverter's maximum input voltage of 600V.
- It is recommended to install a PV disconnect switch between the inverter and PV modules.
- It is very important for system safety and efficient operation to use proper cable for PV module connection as shown in the table above.
- When connecting multiple inverters in parallel, a single string cannot be shared between inverters. Each string must be connected to its own MPPT.
- Navigate to the [EG4® Solar Panel String Sizer](#) tool for additional assistance.

PV INPUT DATA	DESCRIPTION	PARAMETER
DC Input Voltage Range	Range required for the unit to operate up to maximum input	100 – 600 VDC
Unit Start-up Voltage	Voltage needed for the unit to turn on	100 VDC
Load Output Minimum Voltage	Minimum voltage needed to output power on the load side	>140 VDC
MPPT Operating Voltage Range	Range where the MPPT can track	120 – 440 VDC
Full Power MPPT Voltage Range	Range where the MPPT operates at maximum capacity	250 – 440 VDC
Nominal MPPT Voltage	Voltage at which MPPT will operate most optimally	360 VDC
Maximum Utilized Solar Power	Wattage the unit can utilize from the solar array	21kW
Recommended Maximum Solar Input	Suggested PV power input to the device to utilize the full 21kW of PV	25kW



NOTE:

Navigate to the [EG4® Solar Panel String Sizer](#) tool for additional assistance.

<https://eg4electronics.com/wp-content/themes/hello-elementor/eg4-solar-panel-string-sizer/>

String Usage & Sizing

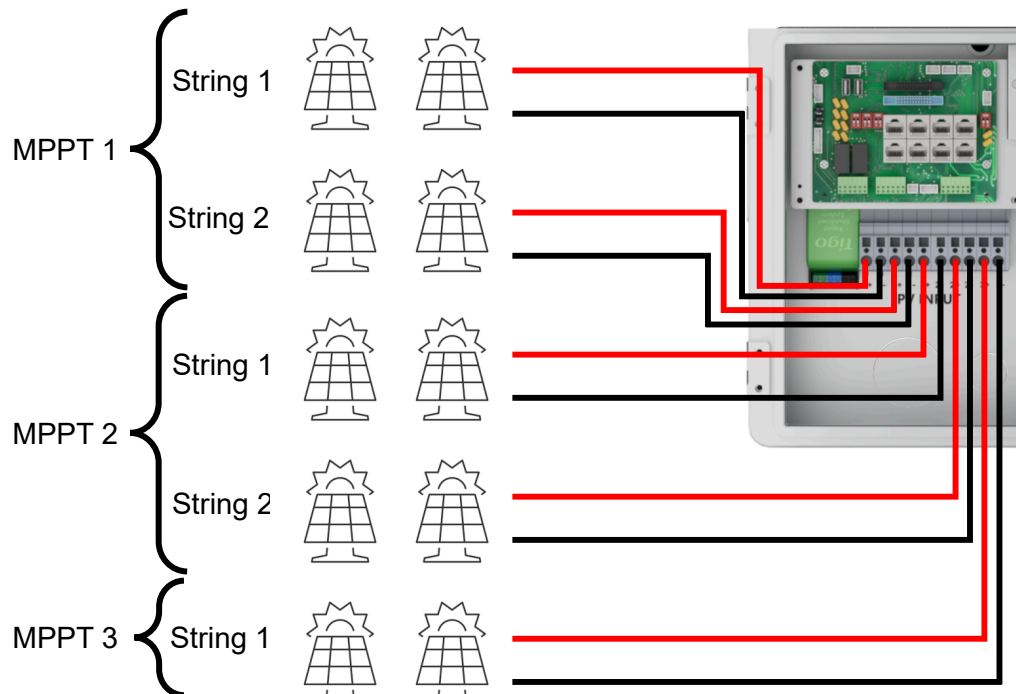

- The maximum utilized solar input of the inverter is 21kW (DC).
- MPPT 1 and MPPT 2 can each utilize up to 26A of solar input, with a maximum input of 31A. Exceeding 31A can damage the equipment.
 - When both strings of the same MPPT are used, the inverter will parallel the two strings together. Each of the single strings cannot exceed 13A. This is to ensure the total amperage of the paralleled strings does not exceed 26A (Imp).
- MPPT 3 can utilize up to 15A of solar input, with a maximum input of 19A. Amperage over 19A can damage the system.
- Verify each string does not exceed the inverter's MPPT circuit ratings. Double check if the calculated VMP range is within the 120 – 440 VDC optimal MPPT circuit operating range. Consult a solar designer if needed.
- All panels on a string should face the same orientation and be exposed to roughly the same shading across the string. Consideration should be placed on string location and wiring order on the racking to minimize shading effects. One shaded module can disproportionately reduce output for the entire string. Optimizers can help counteract the effects of partial shading.
- When using both strings within an MPPT, both strings should ideally contain the same model, brand, and quantity of panels for ease of design, racking, and wiring
- When solar modules are put in a series, the voltage multiplies by the number of modules and the amperage stays the same as each module.
- When solar strings are put in parallel, the amperage multiplies by the number of strings and the total voltage of the string remains equal to the voltage of a single string.
- When utilizing an external OCPD, use an OCPD rated for 600V/20A for each string. Check with the local AHJ for requirements.



NOTE:

Navigate to the [EG4® Solar Panel String Sizer](#) tool for additional assistance.



NOTE:

For all modules, the calculations need to be performed or verified by using a string calculator or consulting a professional.



DANGER:

DAMAGE WILL OCCUR if the string voltage on a cold, sunny morning exceeds the inverter's maximum input voltage of 600V!



IMPORTANT:

The array can have a higher I_{mp} than the 26A/15A specified, but the MPPTs will not make full use of the extra current. Having an array that can produce more current than the MPPTs can utilize is useful for increasing morning, winter, or cloudy day solar production. An I_{sc} higher than 31A/19A will cause damage to the inverter.

Steps for PV Wiring:

1. Ensure all breakers and disconnect switches are in the OFF position before connecting or disconnecting wires. Use a voltmeter to confirm there is no voltage present.
2. Strip off 1/2 in. – 2/3 in. (12.7 mm – 17 mm) insulation on the PV string's positive and negative conductors.

Note: Use wire ferrules for the PV string conductors if they are stranded wires.

3. Insert the conduit fitting into the opening for the PV connection and tighten it from the inside using the counter nut.
4. Route the PV conductors through the conduit fitting and into the inverter.
5. Secure the PV conductors in place into the inverter inputs by inserting a flathead screwdriver into the square and the conductor into the circular input. Verify that they are secured properly by *lightly* pulling on them.
6. Ensure the conduit and conduit fittings are fastened securely and the cable entry holes are sealed.

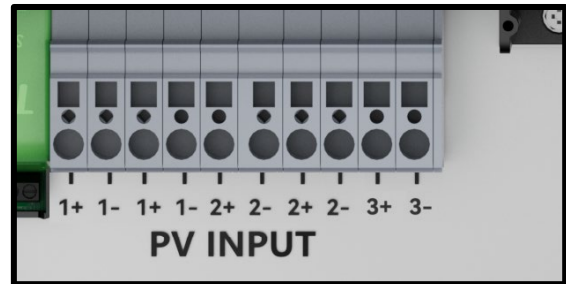

7.6 AC WIRING INFORMATION

When sizing AC wires, adhere to the following information*:

CONNECTION	MAXIMUM BREAKER SIZE	MAX. SUPPORTED CABLE SIZE	TORQUE VALUES
Grid	90A	2 AWG (50 mm ²)	93 in-lbs. (10.5Nm)
Load	90A	2 AWG (50 mm ²)	93 in-lbs. (10.5Nm)

*Consult installer to ensure that appropriate cable sizing is used due to various factors such as distance, operating voltage, and amperage.



NOTE:

- Always be sure to connect the AC Output ground wire to the Ground terminal first before installing the AC Outputs for L1 and L2.
- If using fine stranded wire, use ferrules to secure the connection.
- When installing multiple inverters in parallel, it is recommended to use equal length AC cables from each inverter to the main panel and from each inverter to the loads panel. This helps ensure the load sharing between each inverter is as even as possible.
- If using in conjunction with GridBOSS, the Load port is not used, see the user manual for more information.

Ground-Neutral Bonding

The information below describes the nature of the ground and neutral in the inverter and their relationship to the system. Always consult with an installer or a licensed electrician to ensure that the right configuration is being used:

- The Neutral of the AC input and the AC output are common (known as a Common Neutral Architecture).
- The neutral line between the AC input and AC output is never disconnected.
- The inverter never creates a neutral-ground bond in any mode of operation.



IMPORTANT:

The system should have only one ground-neutral bond (this is typically the Main Bonding Jumper located at the service entrance main breaker).

Steps for AC Connection

The FlexBOSS21 comes equipped with L1 and L2 terminals for AC input (labeled GRID) and output (labeled LOAD). It is designed to utilize up to 50A of input and up to 66.7A of output. These terminals ARE NOT connected to a breaker; it is recommended to install a separate AC breaker between inverter and AC input power source. This will ensure the inverter can be disconnected during maintenance and fully protected from over current AC input. Check with the local AHJ for requirements for means of disconnect.

1. Before connecting or disconnecting AC wires, ensure all breakers are in the OFF position. Check that there is no voltage present with a voltmeter.
2. Strip 3/5 – 4/5 in. (15.2 mm – 20.3 mm) of insulation from the AC cables.

Note: Use wire ferrules if the cables are made of fine stranded wires.

3. Connect the AC ground wire to the ground bus (**Callout 1**).
4. Fasten the neutral wire into the neutral bus (**Callout 4**).

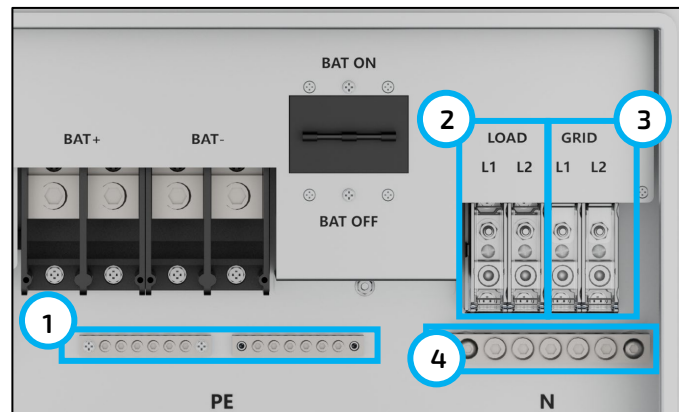

5. Secure the AC wires into their respective mechanical lugs (**Callouts 2 and 3**). Connect lines 1 to L1, and lines 2 to L2. Torque to the specifications in the chart above
6. Check that the cables are connected properly. Take appropriate measures to ensure the conduit and conduit fitting are properly secured and seal the cable entry holes.



CAUTION:

- Do not misconnect the grid input and loads output connections, which could cause damage to the inverter and attached devices.
- Be sure to connect AC wires with correct polarity. If L and N wires are connected reversely, it may cause utility to short-circuit when the inverters are working in parallel operation.

CT Connection

To measure the power imported from and exported to the grid, a pair of CTs or one three-phase meter must be installed at the service entry point in or near the main service panel. Two (2) CTs are provided with each inverter with a 300A rating. For more information, visit eg4electronics.com.



WARNING:

Do not install the CTs when using this inverter with EG4® GridBOSS. If installed, the inverters current output can show false readings in EG4 Monitor Center.

CT Type:

Model: CTSA024-300A/100mA **Technical Specification:** 240V/208V, 300A/100mA

CT Port Pin Definition:

The CT interface for the two (2) CT connections is an RJ45 port. The two (2) CTs come with a premade plug that can be connected directly to the port.

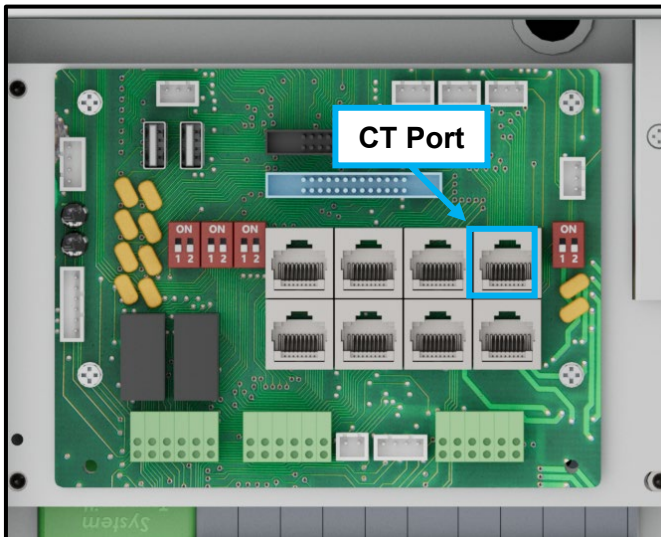

PIN	DESCRIPTION
1 – 4	Reserved
5	CT2N
6	CT2P
7	CT1N
8	CT1P

Refer to the connection diagram to the right for the correct position of the CTs. Clamp the 2 CTs onto the L1 and L2 wires at the service entry point in the main service panel as close to the meter base as possible.

The arrows on the CTs must point toward the inverter and be placed on the proper line based on their number. (CT 1 for L1, CT 2 for L2)

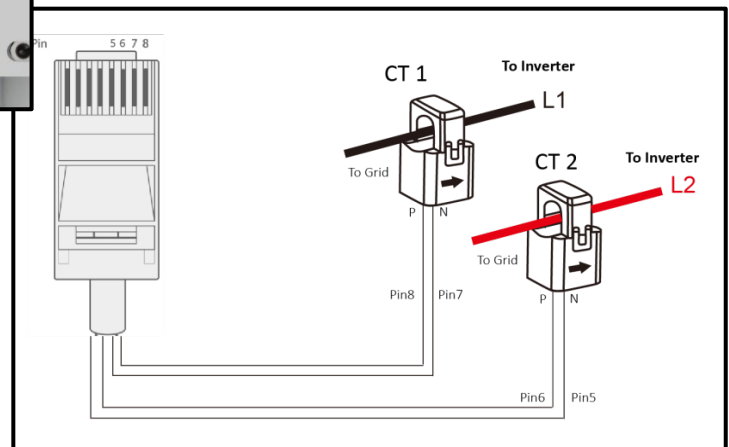

CT Clamp Ratio:

The inverter supports three ratios of CT clamps: 1000:1, 2000:1, and 3000:1. The included CTs are 3000:1.

If using a 3rd party CT, ensure the CT ratio is of the supported types. Be sure to select the correct CT ratio setting on the inverter.

Black= L1
 Red= L2
 Orange= Neutral
 Grey= Communication Cable

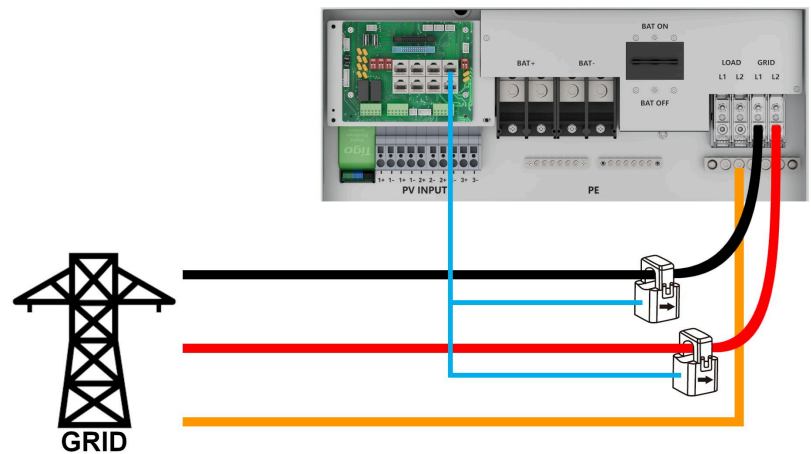

Extending the CT Clamp Cable:

The CT wires can be extended with a common ethernet cable if they are not long enough. An RJ45 adapter is needed for the extension. The CT wires can be extended up to 300 ft. (around 90 m).

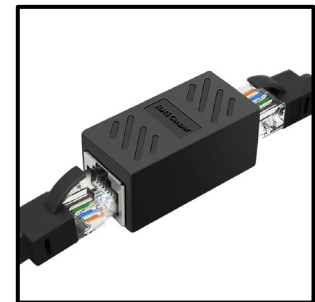

7.7 PARALLEL SYSTEM CONNECTION



REMINDER:

- All setting changes for parallel inverters must be done while in Standby Mode.
- If the system is connected to a lithium battery, the host battery must communicate with the inverter that is set as master in the parallel system.
- Each inverter must be properly configured for parallel mode before outputting current on the loads port. If the proper configuration is not followed, damage could be caused to the inverter and devices connected.
- Keep all settings the same for each inverter in the parallel system on the remote monitor!!
- If the number of PV panels connected to each inverter cannot be evenly divided, it is recommended to have more PV panels on the master inverter.

Connections for Parallel System:

The hybrid inverter supports parallel connection to expand power and energy capacity to suit different usage scenarios. Up to 16 units can be paralleled to reach a capacity of 256kW. The inverters can be used in single phase, or in a three phase system (for three or more inverters). The parallel wiring diagrams are as follows.



REMINDER:

Put the CAN communication pin to ON status for the first and last inverter and OFF for the inverters in between. Both switches in the "ON" position translate to address 1. Both switches in the "OFF" position translates to address 0. If needed, contact the inverter distributor for more detailed guidance on paralleling the system.



REMINDER:

If the inverter-to-inverter paralleling cable needs to be extended, ensure the cable is a straight-through CAT5 or higher CAT-rated cable. See image below for reference.

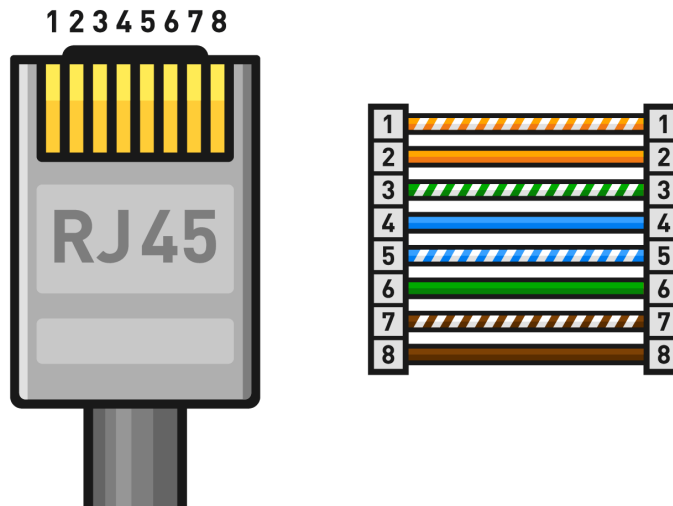

1. Set the CAN communication PIN to ON position for the first and the last inverter. Set the PIN to the OFF position for any inverters between the first and last. Both switches in the "ON" position translates to address 1. Both switches in the "OFF" position translates to address 0.
2. Install the included parallel cable (grey in color) to the parallel port on each inverter as shown in the diagram below. If only two inverters are installed only one parallel cable is required. Two parallel cables will provide redundancy in the event one cable is disconnected or stops working. See image below:

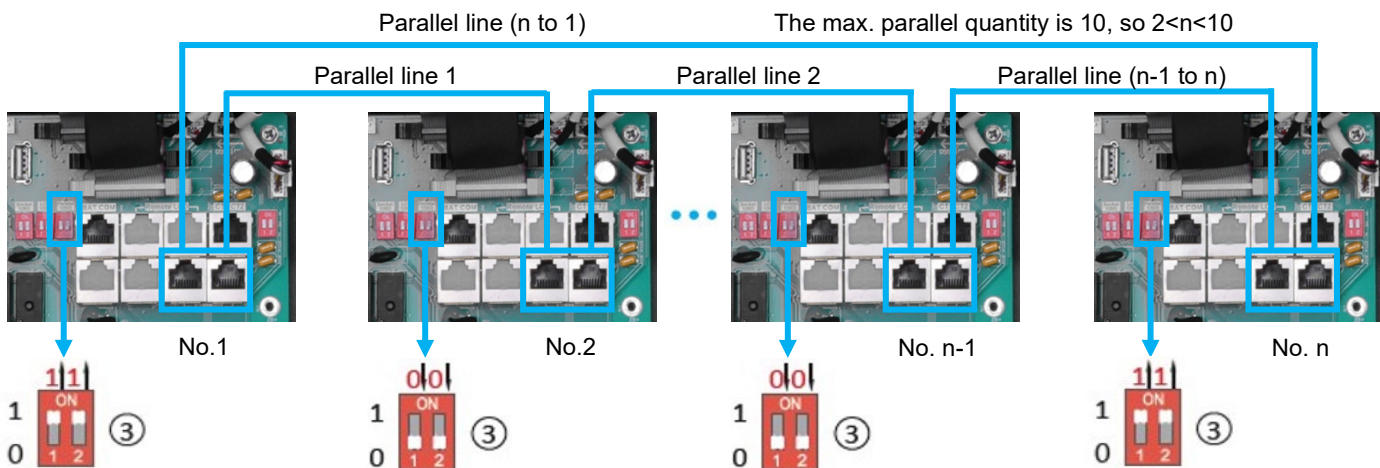

3. Ensure each inverter circuit breaker is in the open (OFF) position. No voltage should be coming in or out of the inverter at this point.
4. Using a multimeter, check the following:
 - a. Check the battery bank voltage is within operating range at the inverter DC breaker, or the external DC disconnect.
 - b. Check the PV voltage is within operating range at input connections of the DC isolation switch.
 - c. If utilizing AC input, double check each hot line to neutral connection supplying power to the inverter to ensure voltage is in operating range of the unit.
5. Upon confirming all voltages are within the inverter's operating range, set the inverter battery breaker to the closed (ON) position. If equipped, set the external battery breaker installed between the battery bank and inverter to the closed (ON) position.
6. Begin powering on the master battery. Then power on each additional battery in ~5 second intervals.
7. Move the external PV isolator switch to the closed (ON) position (if equipped). Set the PV switch on the side of the inverter to the closed (ON) position.
8. If using AC input, set the external breaker between input panel and inverter to the closed (ON) position. Next, set the inverter GRID breaker to the closed (ON) position.
9. Check the front LED display to confirm unit powers on.
10. Configure the following settings using the EG4 Monitor Center or mobile app:
 - a. Common Tab (see section 11.1)
 - b. Application Tab (see section 11.2)
 - c. Discharge Tab (see section 11.5)
11. Power off all inverters. Then power on the master. Once the master inverter is powered up, power on each additional inverter.
12. After all the inverters are powered up, double check each inverter and verify the system type is set to "Parallel" and the battery shared option is selected.
13. Ensure the battery communications cable is properly connected from master battery to the master inverter.
14. Using the EG4 Monitor Center, mobile app, or LED indicators on the front of the unit, verify there are no faults or alarms.
15. Verify the loads panel is ready to accept current from the inverter. Set the input breaker at the loads panel to the closed (ON) position.
16. Set the output breaker on inverter to the closed (ON) position. The inverter should now be providing current to the loads panel.

Parallel Configuration:

1. Before commissioning the system, verify that all inverters are updated to the latest firmware. Visit www.eg4electronics.com for the latest firmware version.
2. Make sure the power cables and parallel communication cables have been wired correctly and verify the DIP switch configurations are correct.
3. Power on the inverters.
4. Login to the Monitor Center Website or the EG4® Electronics app. See section 10 for more information on how to access these and detailed information on how to use the app and website.
5. Ensure all dongles are on one station, contact the installer or distributor for more information.

Commissioning Steps via the Monitor Center Website:

1. On the Monitor Center website, select which unit to set as the “Master” in the drop-down menu at the top of the page.
2. Select “Maintenance” and scroll to “Application Setting.”
3. Select “1 Phase” or “3 Phase Master” under “Set System Type” (a three-phase system must have three or more inverters).
4. Select “U Phase” under “Set Composed Phase.”
5. Enable “Share Battery.”
6. Enable “Parallel Setting Data Sync.”
7. On all other inverters, select “Slave” under “Set System Type” and repeat steps 4 through 6 for single phase systems. Continue to the Finish Commissioning Steps below.
8. For three phase systems, the phasing will be set to “U Phase” for the master, “V Phase” for the first slave, and “W Phase” for the next. The pattern will repeat for each subsequent inverter, restarting at “U Phase.” See Finish Commissioning Steps below:

The screenshot displays the EG4 Electronics Monitor Center Website interface. At the top, there is a navigation bar with tabs for Monitor, Data, Configuration, Overview, and Maintenance (which is highlighted with a blue box). Below the navigation bar, there is a 'Remote Set' section with a dropdown menu labeled 'Select station first' and a 'Read' button. The main content area is titled 'Application Setting' and contains various configuration options. A blue box highlights the 'Parallel System' section, which includes the following settings:

- Set System Type (?)**: A dropdown menu currently set to '<Empty>' with a 'Set' button.
- Set Composed Phase (?)**: A dropdown menu currently set to '<Empty>' with a 'Set' button.
- Share Battery (?)**: A toggle switch currently set to 'Enable'.
- Parallel Setting Data Sync (?)**: A toggle switch currently set to 'Enable'.

Other visible settings in the 'Application Setting' section include:

- No Batteries (?) [Enable/Disable]
- Power Backup (?) [Enable/Disable]
- Grid Sell Back (?) [Enable/Disable]
- Fast Zero Export (?) [Enable/Disable]
- PV Arc (?) [Enable/Disable]
- Grid Loss Warning Clear (?) [Enable/Disable]
- Normal / Standby (?) [Normal/Standby]
- Micro-Grid (?) [Enable/Disable]
- System Charge SOC Limit(%) [10, 101] [Set]
- Seamless EPS switching (?) [Enable/Disable]
- Grid Sell Back Power(kW) (?) [0, 25.5]
- Off-Grid Mode (?) [Enable/Disable]
- PV Arc Fault Clear (?) [Clear]
- RSD (?) [Enable/Disable]
- Restart Inverter (?) [Restart]
- Max. AC Input Power(kW) (?) [0, 6553.5]
- System Charge Volt Limit(V) [40, 59.5]

Commissioning Steps via the EG4® App:

1. On the EG4® Electronics App, select the “Setting” icon.
2. At the top, select the device to set as the “Master” in the drop-down menu.
3. Toggle the “Standby/Normal” setting off.
4. Select “Application Setting.”
5. Select “System Type” and set to either “1 Phase Master” or “3 Phase Master” (three phase must have three or more inverters).
6. Select “Composed Phase” and set to “U Phase.”
7. Toggle “Share Battery” on.
8. Select the inverters to set to “Slave” in the top drop-down menu and select “Slave” in “System Type” setting. Repeat steps 6 and 7 for single phase systems. Once finished with all inverters, continue to the Finish Commissioning Steps below.
9. For three phase systems, the phasing will be set to “U Phase” for the master, “V Phase” for the first slave, and “W Phase” for the next. The pattern will repeat for each subsequent inverter, restarting at “U Phase.” See Finish Commissioning Steps below:

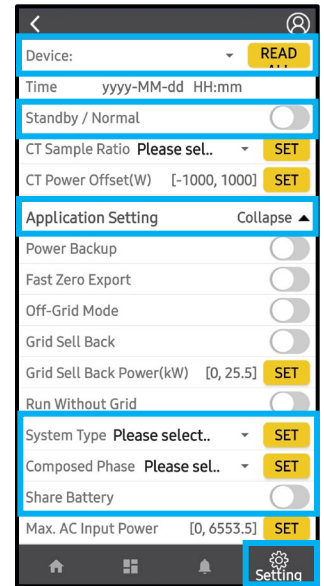

Finish Commissioning Steps:

1. Turn on the battery and make sure the communication works on all units.
2. Check the parallel info via the app or website.
3. Enable “Power Backup” under “Application Setting.”
4. Before connecting loads to the load output terminal, check the output of L1 and L2, and L1 and N with a multimeter.
5. Add small loads to the load output and verify power output.
6. Finish the commissioning by switching all inverters from “Standby” to “Normal.”

7.8 GRID, LOAD, AND AC INFORMATION

This inverter can be used in 120/240V or 120/208V. The default setting is 120/240V. This inverter has passed the main grid connection regulations in the United States. Users can choose the different grid types and regulations in the “Grid Connect Setting,” on either the app or the website. On the website, this setting can be found under the Maintenance tab. On the app, this setting can be found under the “Setting” icon at the bottom of the page. For more information on the app and website, see section 10.

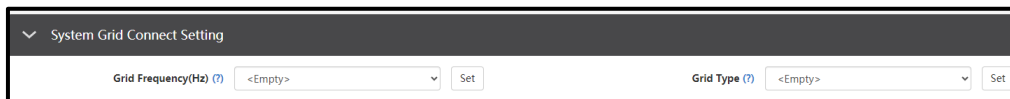
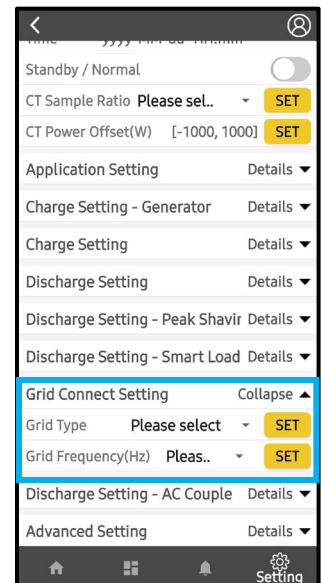

7.9 RAPID SHUTDOWN/ESS DISCONNECT

The inverter includes a rapid shutdown system with built-in RSD transmitter and RSD/ESS disconnect initiator.

In case of emergency, press the rapid shutdown button to cut off the power supply, cutting the inverter's AC output along with dropping the PV conductor's voltage to <30V in 30 seconds.



NOTE:

When using supported EG4® batteries in closed-loop communications with the inverter, the RSD also initiates ESS disconnect as required by NEC code.



External RSD

The system can utilize an External E-Stop Switch if the local AHJ deems it necessary.

- The external switch must be “Normally Closed” by default, and “Open” when the button is pressed for emergency shutdown.
- The external switch should be connected to the RSD terminals on the inverter and mounted on a readily accessible location outdoors (check with the local AHJ for requirements).
- Remove jumper from external RSD connection and wire the E-Stop Switch into the RSD terminals according to the switch's specifications.

External RSD Wiring:

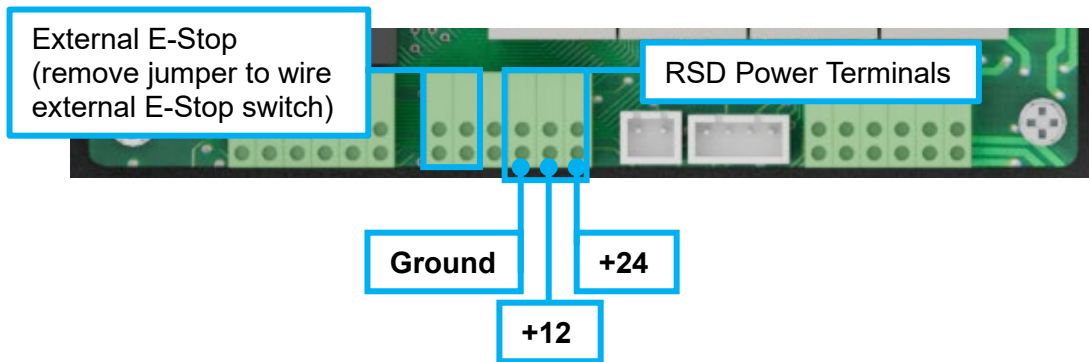

8. INVERTER START-UP AND SHUTDOWN PROCEDURE

Starting up the inverter

1. If using an external DC breaker between the battery bank and the inverter, turn it on. If not, turn on the BAT breaker located in the cable box of the inverter and then power on the battery system one battery at a time.
2. Make sure the PV voltages of the strings are within operating parameters (over 100V). Turn on the PV isolator switches between the inverter and array, and then turn on the switch on the side of the inverter.
3. Make sure Steps 1 and 2 are running properly and then turn on the grid power breaker.
4. Power on the load breakers in the load panel.



DANGER:

Never disconnect the battery, PV, or AC input power under load. If there is an emergency and users must shutdown the inverter, use rapid shutdown or follow the steps outlined below.

Shutting down the inverter

1. Set the inverter into Standby mode using either the mobile app or EG4® Monitor Center.
2. Switch off the load breaker.
3. Turn off the grid breaker feeding the inverter.
4. Turn off the PV disconnect and then the battery breaker. Wait for the LED lights to go off.

9. WORKING WITH A GRIDBOSS

While the FlexBOSS21 is a hybrid inverter that is capable of functioning on its own, pairing it with the EG4® GridBOSS allows for more flexibility and functionality.

FUNCTION	DESCRIPTION
AC Coupling	Allows the user to pair the FlexBOSS21 and GridBOSS with an existing solar system.
Smart Loads	Smart loads control devices that are powered on or off according to time of use and battery state of charge.
Generator Functions	Allows the user the option of a backup generator for when the grid is down and PV is insufficient to power loads.



CAUTION:

When pairing with GridBOSS, ensure the FlexBOSS21's firmware is updated to at least version 1E1E or the units will not operate as intended!

When installing both GridBOSS and FlexBOSS21 together:

- Check that the firmware is up to date, with the minimum firmware being 1E1E.
Note: *Once the firmware has been updated, it cannot be undone.*
- Ensure the mounting wall is strong enough to bear the weight of all units.
- Maintain at least 150 mm of spacing between units.
- Observe all environmental specifications for all units.
- The Loads port will not be used on the FlexBOSS21.
- The CT clamps provided with the inverter will not be used as all input/output data will be tracked by GridBOSS.
- Ensure that all parallel inverters are configured before configuring GridBOSS.

For more information on GridBOSS and specific use cases, scan the following QR code:



GridBOSS
User Manual

10. MONITOR SYSTEM SETUP

There are multiple ways for the inverter to be programmed and monitored. The most common and convenient are the EG4[®] Monitor Center Website (monitor.eg4electronics.com) and the EG4[®] Monitor App. The following sections discuss the various ways to communicate with the inverter.



Monitor Center
Website



Monitor Center
Overview



Monitor App
for Android



Monitor App
for Apple

10.1 WI-FI/4G DONGLE CONNECTION

A Wi-Fi/4G dongle is used to monitor the inverter and remotely view the monitoring data on a computer or mobile device. Attach this module by plugging it in to the side of the inverter and securing it with the four (4) Phillips head screws.

10.2 CONNECTIVITY REQUIREMENTS

Due to certain limitations of the Wi-Fi Dongle, please ensure that the home Wi-Fi network signal and security settings meet the following requirements:



- The Wi-Fi dongle only supports wireless networks in the 2.4GHz frequency band. If the router supports the 5GHz or 6GHz network frequencies, please confirm the router supports the 2.4GHz network frequency band and it is enabled.
- The Wi-Fi dongle is compatible with WPA1, WPA2, and WPA3 security protocols on the 2.4GHz network only.
- Ensure the Wi-Fi dongle can obtain an IP address by verifying the home Wi-Fi router has DHCP (Dynamic Host Configuration Protocol) setup and it is enabled.
- It is recommended the home Wi-Fi network name length does not exceed 19 characters, and the password length does not exceed 24 characters. It is *not* recommended to use any of the following special symbols in the password: @, #, \$, %, &, *, ?, _, /, or using a space “keyboard spacebar”.

For Wi-Fi Dongle troubleshooting, scan the following QR code:



Dongle Troubleshooting Guide

10.3 ONLINE MONITORING SYSTEM USER INTERFACE



NOTE:

The monitoring system may change due to updates. Therefore, UI descriptions may vary from the current pages on the site. Scan or select the QR code below to navigate to the Monitor Center Overview guide. If you have any questions, or to create distributor or installer accounts, contact support@eg4electronics.com for assistance.

After connecting the Wi-Fi dongle, create an account by registering at monitor.eg4electronics.com. For more information on Monitor Center and the settings that can be adjusted there, scan the following QR code:



Monitor Center Overview

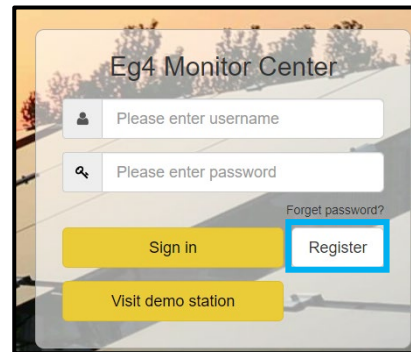

10.4 EG4® MONITOR APP SETUP

Register a monitoring account and set the Wi-Fi password for the Wi-Fi dongle by following the steps below before using EG4's monitoring system.

1. Register an account:

Visit monitor.eg4electronics.com or download the EG4® Monitor app to register for an end user account. Contact support@eg4electronics.com for distributor or installer accounts.

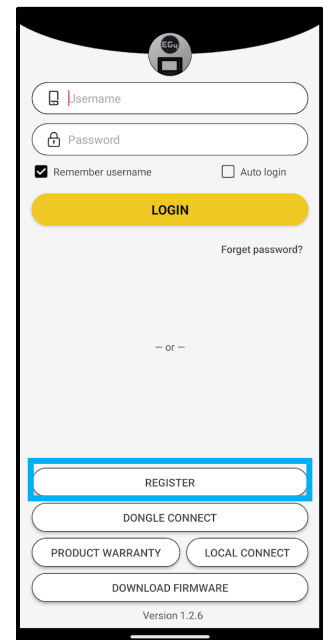

2. **When registering the account, provide the following information:**

Select the box to scan the QR code on the dongle shell to automatically input the information.

- Customer code: Contact the distributor or installer to obtain this code.
- Dongle SN: The serial number is attached to the dongle shell.
- Dongle PIN: PIN is attached to the dongle shell below the SN.



3. **Set the Wi-Fi password:**

- Plug in the Wi-Fi dongle and power on the inverter.
- Wait until the INV LED on the Wi-Fi module is solid on, then connect a mobile device to the dongle's Wi-Fi hotspot. The hotspot name is the same as the Wi-Fi dongle serial number.
- Open the app. Select the "DONGLE CONNECT."
- Select the yellow refresh button to display a list of available networks. Select the desired wireless network name and enter password.
- After selecting "HomeWifi Connect," the Wi-Fi dongle will reset. After the correct password is set, three lights will be solid on, which means the inverter is connected to the server. Disconnect the device from the dongle's hotspot and return to the login page and input username and password to begin monitoring the system.

10.5 ENABLE APP NOTIFICATIONS

The EG4® Mobile App allows the end user to easily check real-time system information regarding the inverters, batteries, and other informative values.

Enable Notifications in Monitor Center:

1. Go to monitor.eg4electronics.com and login.

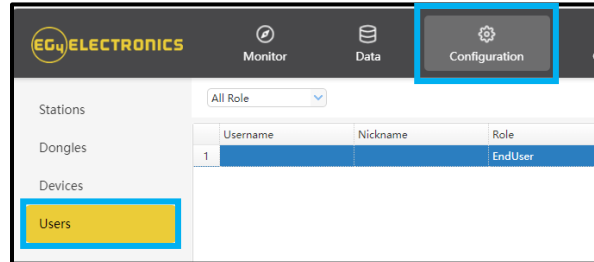

2. At the top of the screen, select “Configuration,” then “Users.”
3. Select “User Management,” then “APP Notice.”

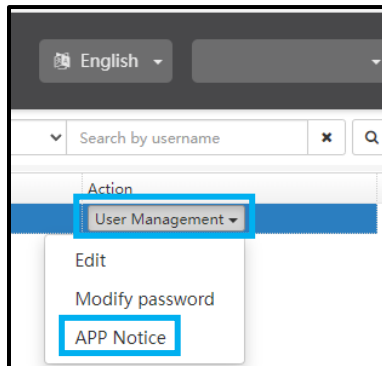

4. Choose which setting to enable, and what values will trigger a notification. Select “Edit.”

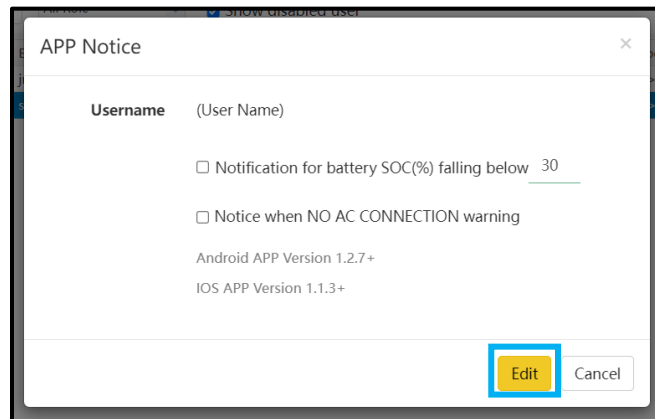

Enable Notifications on a Mobile Device:



NOTE:

Make sure the app is up to date before beginning!

1. Login to the EG4® Monitor App. Select the user icon at the top right corner of the screen.

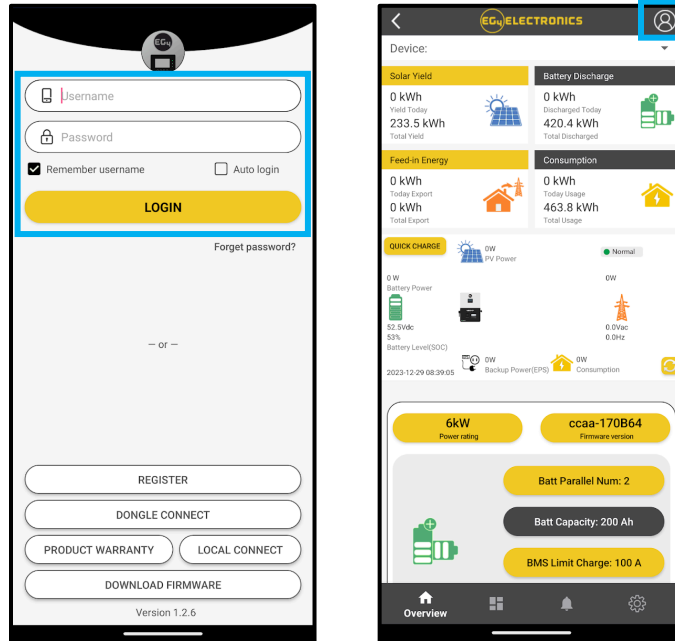

2. Select “Notifications,” “Allow Notifications,” and make selections for which notifications to receive. Toggle selection on to “Allow Notifications” on device and choose how to receive notifications.

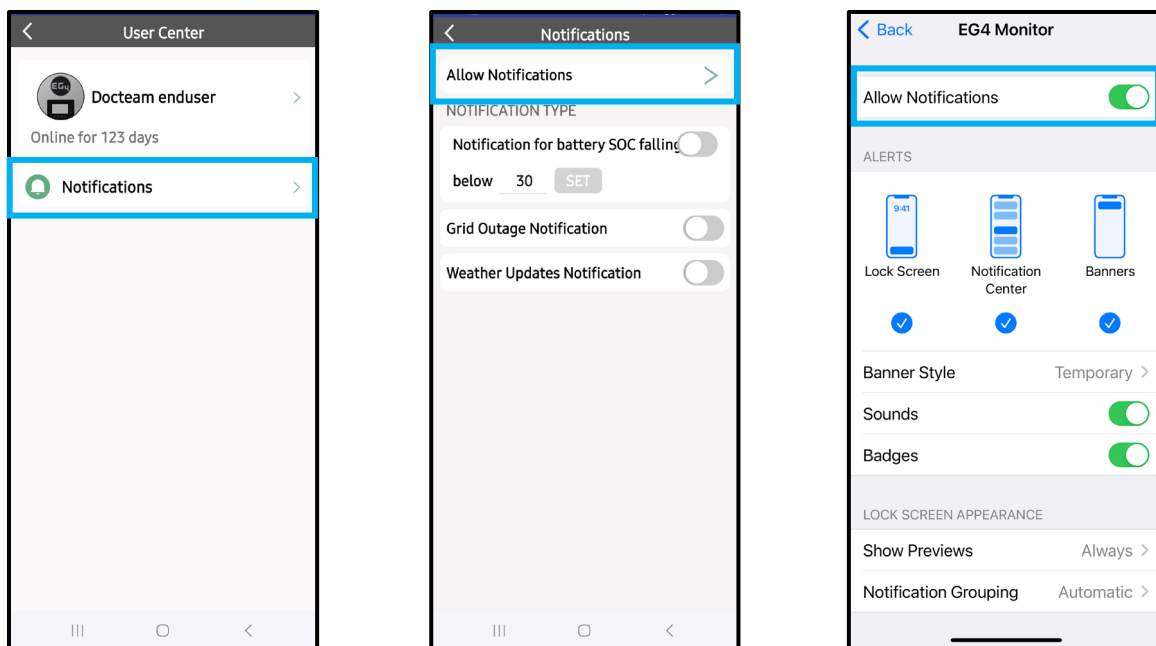

10.6 LOCAL MONITORING SETUP WITH THE EG4® MONITOR APP

If there is no Wi-Fi available at the location, use the local function to monitor or set up the system:

1. Download the EG4® Monitor app.
2. Connect the mobile device to the dongle's Wi-Fi hotspot after the INV LED on the Wi-Fi module is solid on. The name of the hotspot is the same as the serial number on the Wi-Fi module shell.
3. Select "Local Connect." Now the system can be monitored and set up either through the hotspot connection or Bluetooth (on Android devices only).

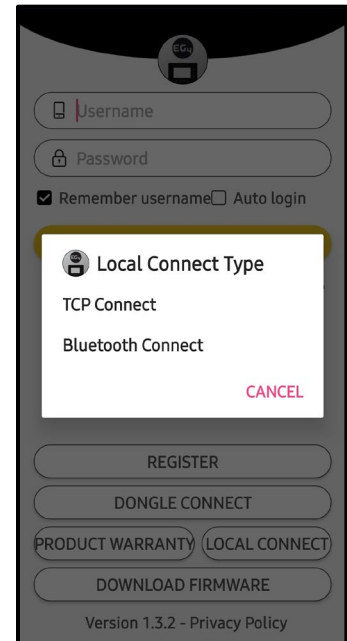

11. MONITOR CENTER SETTINGS



IMPORTANT:

These settings may need to be adjusted after installation. Consult with the installer/distributor before making any changes to avoid conflicting settings or damage to the system!

For the full list of EG4 Monitor Center settings and their functions, refer to the QR code below; the accompanying video provides additional guidance on using the Monitor Center.



EG4 Monitor
Center Overview



EG4 Monitor
Center Video

12. WORKING MODES AND RELATED SETTINGS

Time of Use:

Used to maximize cost savings by flexibly adjusting the battery’s usage pattern, establishing a real-time connection with the grid, and providing live updates on current electricity prices. This enables the system to meet energy demands across different time periods, provide real-time system status, and provide detailed reports. This feature is customizable to individual needs and fluctuations in electricity prices.

Weather Optimize Function

The weather optimize function is used to collect real-time weather data. There are multiple operating modes to adapt to various scenarios:

- Charge Priority Mode prioritizes battery charging to ensure stable electricity usage, making it ideal for areas with unstable power supply.
- Self-Use Mode prioritizes self-generated solar power to meet household electricity demands, making it ideal for areas with high electricity prices.
- Forced Charge/Discharge Mode chooses to charge or discharge batteries based on electricity pricing, making it ideal for time-of-use pricing areas.
- Intelligent Charging Control automatically adjusts the state of charge to maximize the efficient use of solar energy based on real-time weather information.
- Stable Electricity Usage optimizes charging strategies based on weather conditions, ensuring the battery remains adequately charged for stable electricity consumption.

To enable this feature, select “Maintenance” at the top of the Monitor Center webpage. Select “Weather Optimization” to the left of the screen. Select the desired inverter and click the location button.

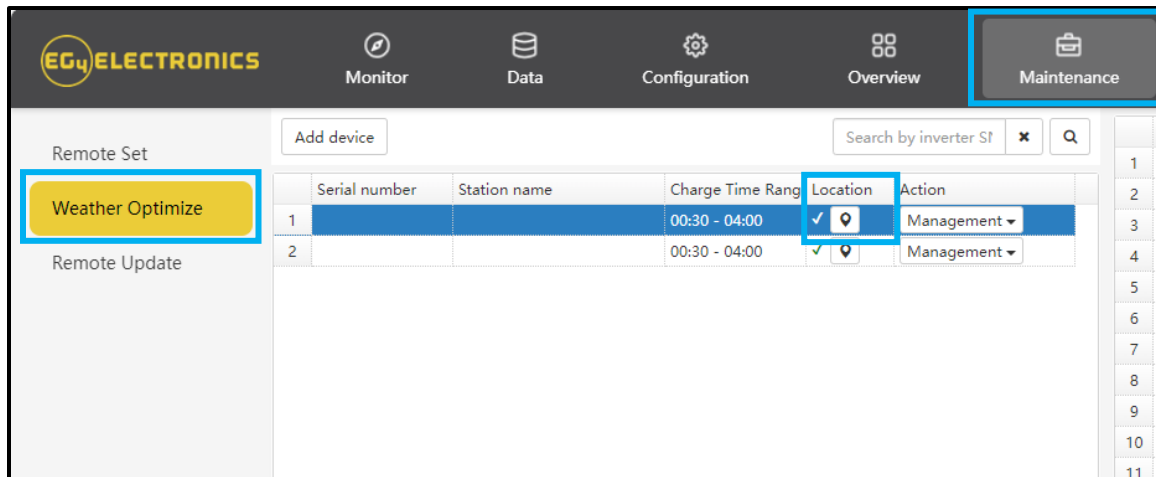

Input the inverter's information on the next screen and select update.

A screenshot of a web form for entering inverter information. The form includes the following fields: * Station name (text input with a checkmark icon), LNG-LAT (text input with a location pin icon), * Create time (text input), * Continent (dropdown menu with 'North America' selected), * Region (dropdown menu with 'North America' selected), * Country (dropdown menu with 'United States of America' selected), * Timezone (dropdown menu with 'GMT -6' selected), and * Daylight saving time (radio buttons for 'Yes' and 'No', with 'No' selected). At the bottom, there are three buttons: 'Update' (highlighted with a blue box), 'Export', and 'Cancel'.

Afterwards, select “Management,” then “Edit.” Set charging times and percentages based on electricity use patterns and weather conditions. The platform sends user settings to the inverter, and the inverter provides feedback, confirming the receipt of setting and executing charging operations according to user-defined parameters.

A screenshot of a web form for setting charging parameters. The form includes the following fields: * Serial number (text input), * Charge Start Time (dropdown menu with '00:00' selected), * Charge End Time (dropdown menu with '00:00' selected, with a blue tooltip message: 'May not charge when end time is equal with start time'), and a section titled 'Charge percent(%) by weather:' containing several rows of text inputs: * Clear sky (Clear sky), * Few(11%-25%) clouds (Few(11%-25%) clouds), * Scattered(25%-50%) clouds (Scattered(25%-50%) clouds), * Broken(51%-84%) clouds (Broken(51%-84%) clouds), * Overcast(85%-100%) clouds (Overcast(85%-100%) clouds), * Light rain (Light rain), * Moderate rain (Moderate rain), * Heavy rain (Heavy rain), and * Other (Other). At the bottom right, there are two buttons: 'Edit' (yellow) and 'Cancel'.

Working Modes

Working modes are pre-set priority systems that allow users to configure the system to meet their demands through extensive customizations. These modes can be found under the Maintenance tab by clicking “Working Mode.” Scroll past “Application Setting” to the “Working Mode Setting” section.



Working Mode Definitions:

- **Backup Mode:** Used to save battery power as a last resort. The solar array powers the loads, and when PV is insufficient, loads will pull from the grid. The inverter will only power loads with battery when there are no other options.
- **Peak Shaving:** Used to avoid peak demand charges from the grid by using a combination of settings to limit the power drawn from the grid.
- **AC Charge Mode:** Used to charge batteries with grid power when electricity prices are cheap, and discharge battery power to supply load or export to the grid when electricity prices are high.
- **PV Charge Priority:** Used to charge battery bank with PV; once battery bank is charged, then PV will be used to power loads.
- **Forced Discharge/Export PV Only:** Used to sell PV and/or battery power back to the grid.
- **Self-Consumption:** Used to significantly lower grid consumption. Solar arrays power loads and, when PV is insufficient, batteries power loads; AC is only used as a last resort.

Backup Mode

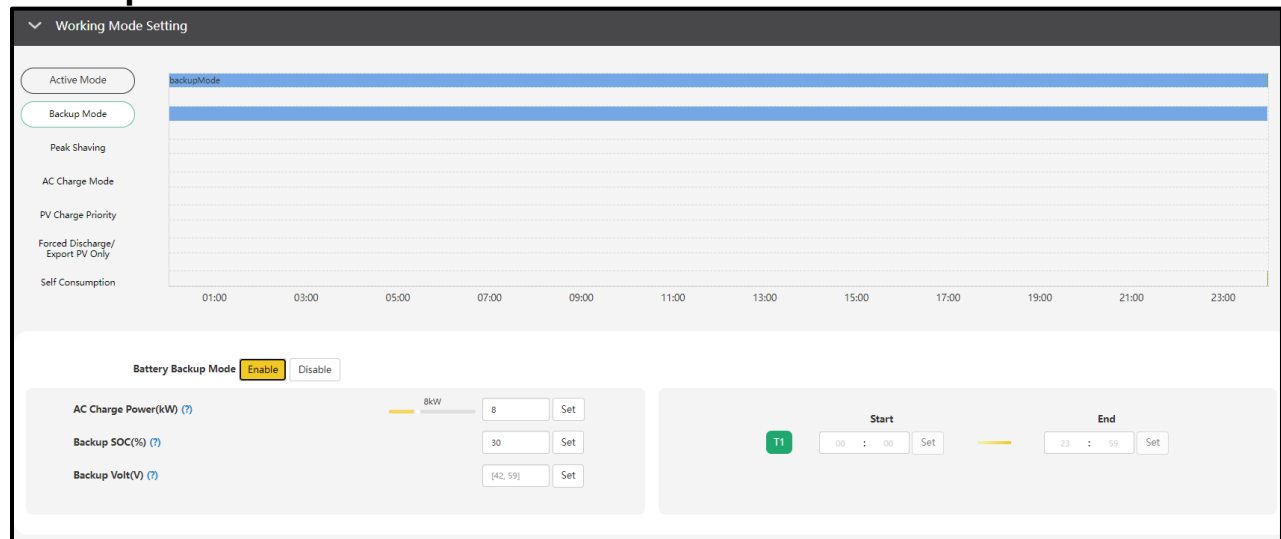

- **Battery Backup Mode:** When enabled, the system will use the batteries as a last resort during the set timeframes.
- **AC Charge Power (kW):** The maximum charging power from grid.
- **Backup SOC(%):** Set the maximum SOC for backup. This parameter is the same as Stop AC Charge SOC.
- **Backup Volt(V):** Set the maximum Voltage for backup. This parameter is the same as Stop AC Charge Volt.
- **Start/End Times:** Set times to begin and end Backup Mode.

Peak Shaving

- **Grid Peak-Shaving:** Enable grid peak-shaving.
- **Grid Peak-Shaving Power(kW)/Grid Peak-Shaving Power2(kW):** Set the maximum amount of power that will be drawn from the grid.
- **Start Peak-Shaving Volt 1(V)/Start Peak-Shaving Volt 2(V):** Set the starting point of peak-shaving when using voltage setpoints for batteries.
- **Start Peak-Shaving SOC 1(%) / Start Peak-Shaving SOC 2(%):** Set the starting point of peak-shaving when using SOC setpoints for batteries.
- **T1/T2 Start/End:** Set the start/end time of peak-shaving depending on SOC/voltage as configured above.

AC Charge Mode

- **AC Charge Enable:** Enable the system's ability to charge batteries from the grid.
- **AC Charge Power(kW):** Set the maximum power drawn from the grid to charge batteries.
- **AC Charge Based On (SOC/Volt/Time):** Configure how the system will charge batteries from the grid by setting custom voltage points, SOC of batteries, or by time.

PV Charge Priority

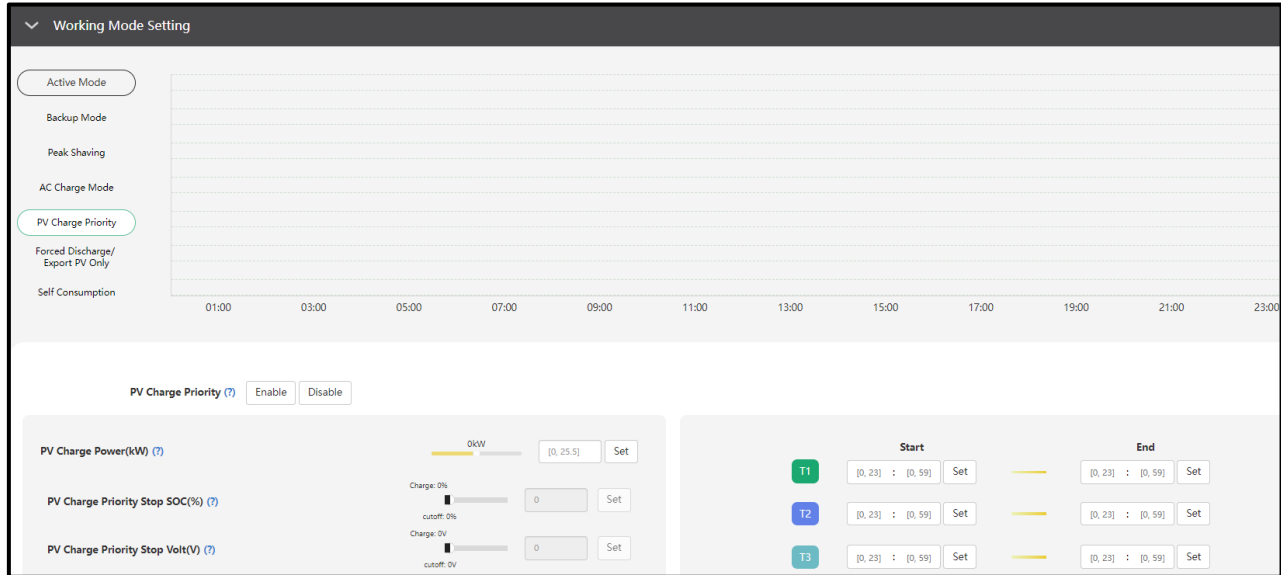

The order of priority for solar power usage will be Battery >Load >Grid. During the “PV Charge Priority” period, loads are first supplied power from the grid. If there is excess solar power after charging batteries, the excess solar will power the loads along with grid power.

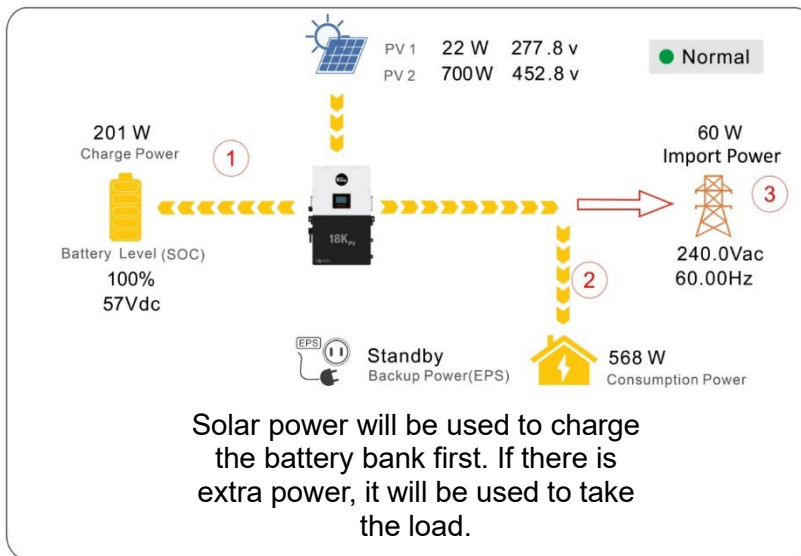

- **PV Charge Priority:** Enable the Battery Priority/PV Charge Priority working mode.
- **PV Charge Power(kW):** Set the maximum amount of power to charge the batteries from solar.
- **PV Charge Priority Stop SOC(%)/Volt:** Set the stop point for PV Charge Priority according to SOC or Voltage.
- **T1/T2/T3:** Set up to three different start and stop times for the PV Charge Priority working mode.

Forced Discharge/Export PV Only

The screenshot shows the 'Working Mode Setting' interface. On the left, a list of modes includes 'Active Mode', 'Backup Mode', 'Peak Shaving', 'AC Charge Mode', 'PV Charge Priority', and 'Forced Discharge/Export PV Only' (which is selected). Below this is a 'Self Consumption' graph with a time axis from 01:00 to 23:00. The main control area includes:

- 'Forced Discharge Enable (?)' with 'Enable' and 'Disable' buttons.
- 'Export PV Only (?)' with 'Enable' and 'Disable' buttons.
- 'Forced Discharge Power(kW) (?)' with a text input field containing '0, 25.5' and a 'Set' button.
- 'Stop Discharge SOC(%) (?)' with a text input field containing '0, 100' and a 'Set' button.
- 'Stop Discharge Volt(V)' with a text input field containing '140, 56' and a 'Set' button.
- A table for scheduling with columns for 'Start' and 'End' times, and three rows labeled T1, T2, and T3. Each row has input fields for start and end times (e.g., '0, 23' and '0, 59') and 'Set' buttons.

- **Forced Discharge Enable:** Enable this setting to forcefully discharge the station's battery bank.
- **Export PV Only:** Enable this setting to sell back generated PV power to the grid.
- **Forced Discharge Power(kW):** Set the maximum power limit of battery discharge.
- **Stop Discharge SOC(%) / Volt:** Stop the forced discharge upon reaching the set SOC/voltage point.
- **T1/T2/T3:** Set up to three different start and stop times for the Force Discharge/Export PV Only working mode.

Self Consumption

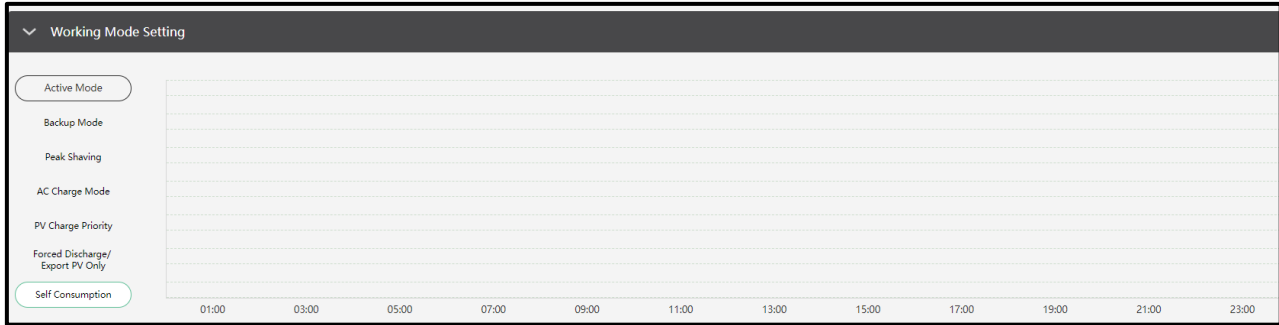

The system will default to Self Consumption mode. The order of priority for powering loads is Solar > Battery > Grid. The order priority for solar power is Load > Battery > Grid which creates an ideal scenario when needing to prioritize solar power generation over other types of power. Self Consumption mode will increase the self-consumption rate of solar power and reduce energy bills significantly. Effective when Charge Priority, AC Charge, and Forced Discharge are disabled.

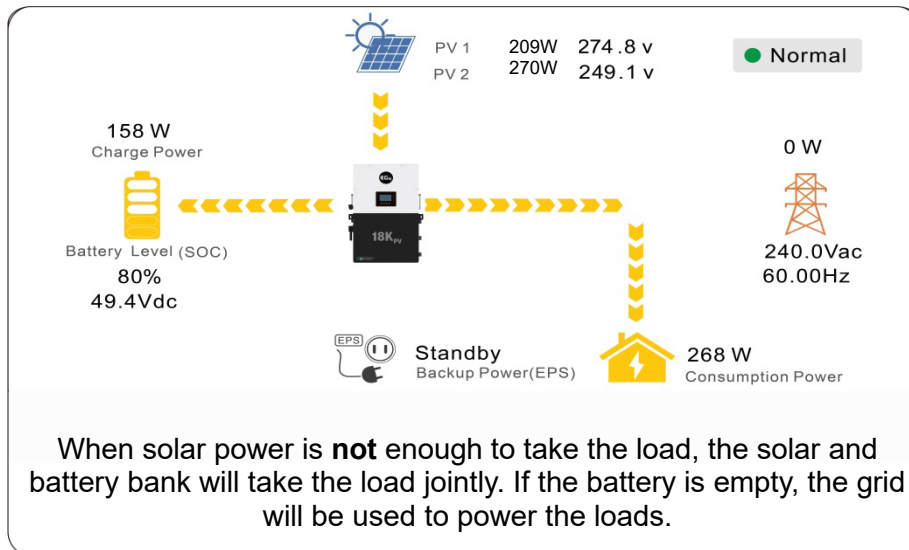
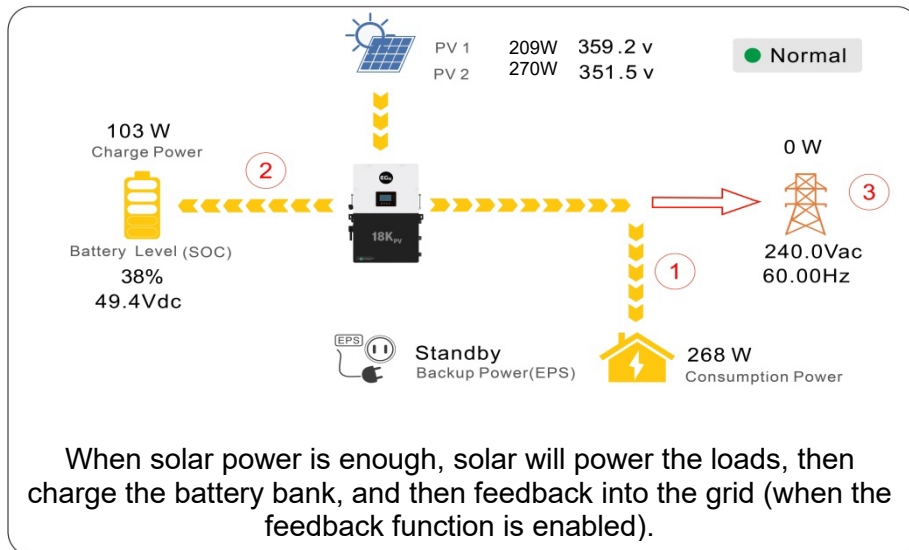

13. POWER CONTROL SYSTEM

13.1 EXPORT LIMITING FROM ALL SOURCES (PEL)

- A. **Export to Grid:** Enables power export to the grid.
- B. **Max export to Grid (kW):** Sets the maximum allowable power export to the grid setting.
 - a. **Note:** To allow power export from the inverter to the grid, "Export to Grid" must be enabled, and "Max Export to Grid" must be set to a value greater than 0. This value defines the upper limit of export power.
- C. **Zero Export:** Disables all power export to the grid.

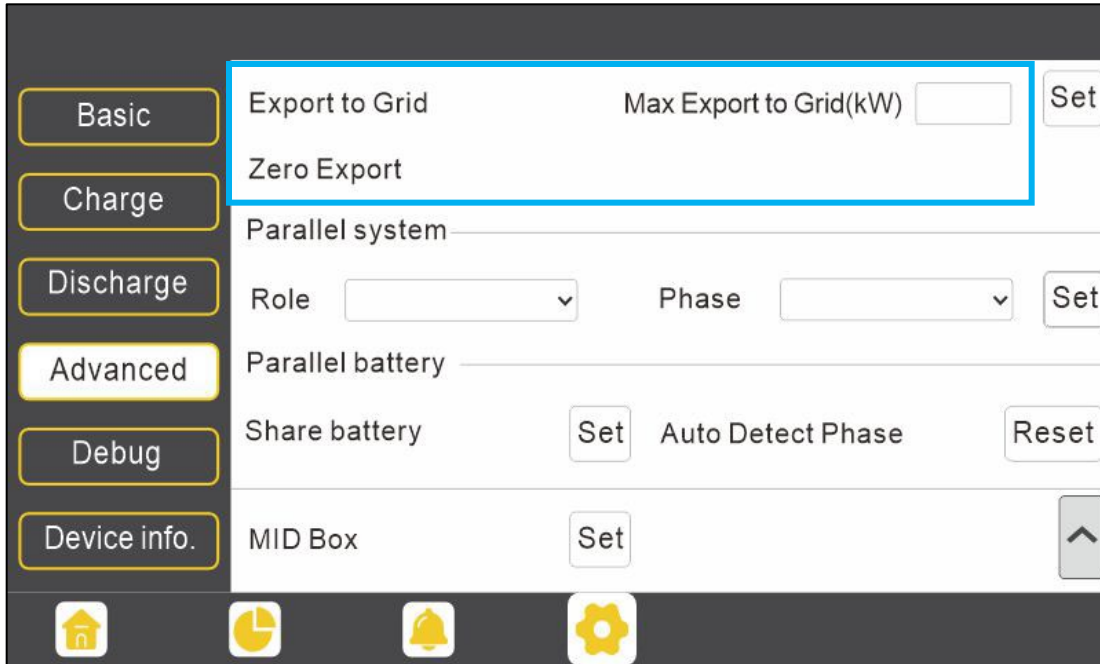

- D. **Discharge current limit (A):** Defines the maximum discharge current allowed from the battery.

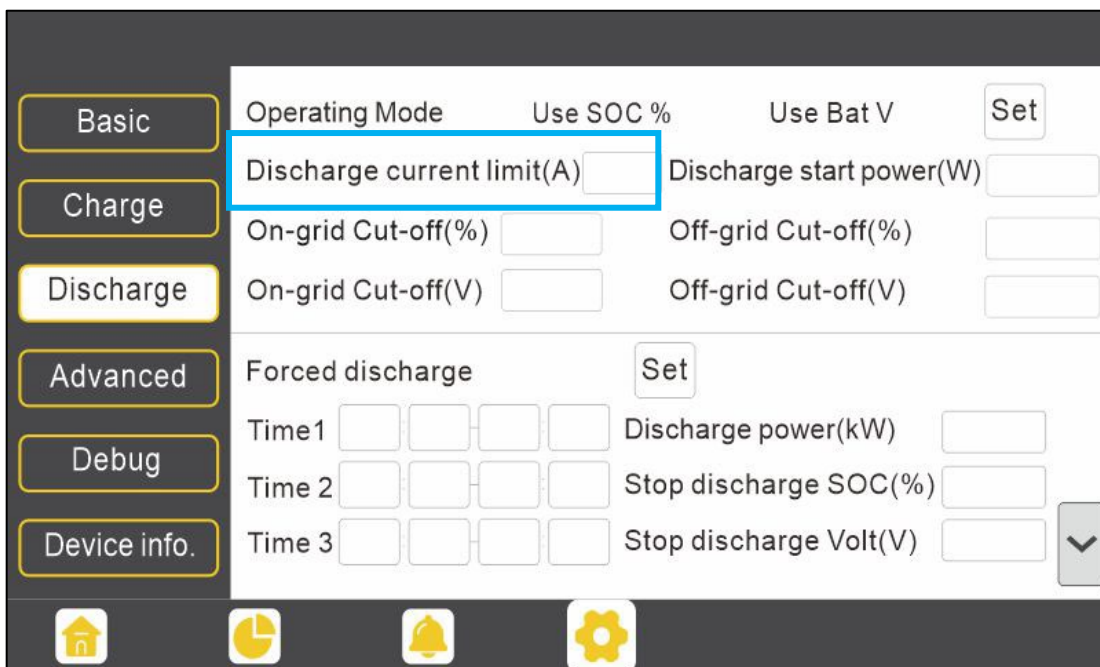

- E. **Discharge power (kW):** Sets the maximum power the battery can deliver when the *Forced Discharge* function is enabled.

The screenshot shows the control interface with the following settings visible:

- Basic:** Operating Mode, Use SOC %, Use Bat V, Set
- Charge:** Discharge current limit(A) [input], Discharge start power(W) [input]
- Discharge:** On-grid Cut-off(%) [input], Off-grid Cut-off(%) [input], On-grid Cut-off(V) [input], Off-grid Cut-off(V) [input]
- Advanced:** Forced discharge [Set], Discharge power(kW) [input] (highlighted)
- Debug:** Time 1 [input], Time 2 [input], Time 3 [input], Stop discharge SOC(%) [input]
- Device info.:** Stop discharge Volt(V) [input]

Prerequisite: Export to Grid is Enabled.

For example: Max Export to Grid is 5kW.

- If the system has battery power but there is no PV coming in (perhaps because the sun is down, or because it does not have PV established in the system). To export power to the grid, the *Forced Discharge* function must be enabled.
 - If Discharge Power is set to 4kW, and the Discharge Current Limit is set to 200A, with a nominal battery voltage of 50V ($200A * 50V = 10,000W$, indicating the power that the battery can output), then the system will export 4kW to the grid.
 - If the Discharge Current Limit is reduced to 50A (With the other settings unchanged from the previous example), the system will export only 2.5kW ($50A * 50V$).
- If the system has PV and battery, but *Forced Discharge* is disabled:
 - Only excess PV power is exported to the grid. The battery does not discharge to the grid.
- If the system has PV and battery, and *Force Discharge* is enabled:
 - Both PV and battery output their available power to the grid, up to the set limits.

13.2 ESS MODE

- **Unrestricted Mode:** The ESS may import active power from the Area EPS while charging and may export active power to the Area EPS while discharging.
- **Export Only Mode:** The ESS may export active power to the Area EPS during discharging but shall not import active power from the Area EPS for ESS charging purposes.
- **Import Only Mode:** The ESS may import active power from the Area EPS for charging purposes but shall not export active power from the ESS to the Area EPS.
- **No Exchange Mode:** The ESS shall not exchange active power with the Area EPS for charging or discharging purposes.



NOTE: *This mode is alternatively known as “No Export Mode”.*

Mode	Maximum Current (Charging)	Maximum Current (Discharging)	Overcurrent Protection (Charging)	Overcurrent Protection (Discharging)
Unrestricted Mode	57.7A/208V 50A/240V	67.7A	72.125A (125%)	84.625A (125%)
Export Only Mode	0A	67.7A	N/A	84.625A (125%)
Import Only Mode	57.7A/208V 50A/240V	0A	72.125A (125%)	N/A
No Exchange Mode	0A	0A	N/A	N/A

Schematic Diagram

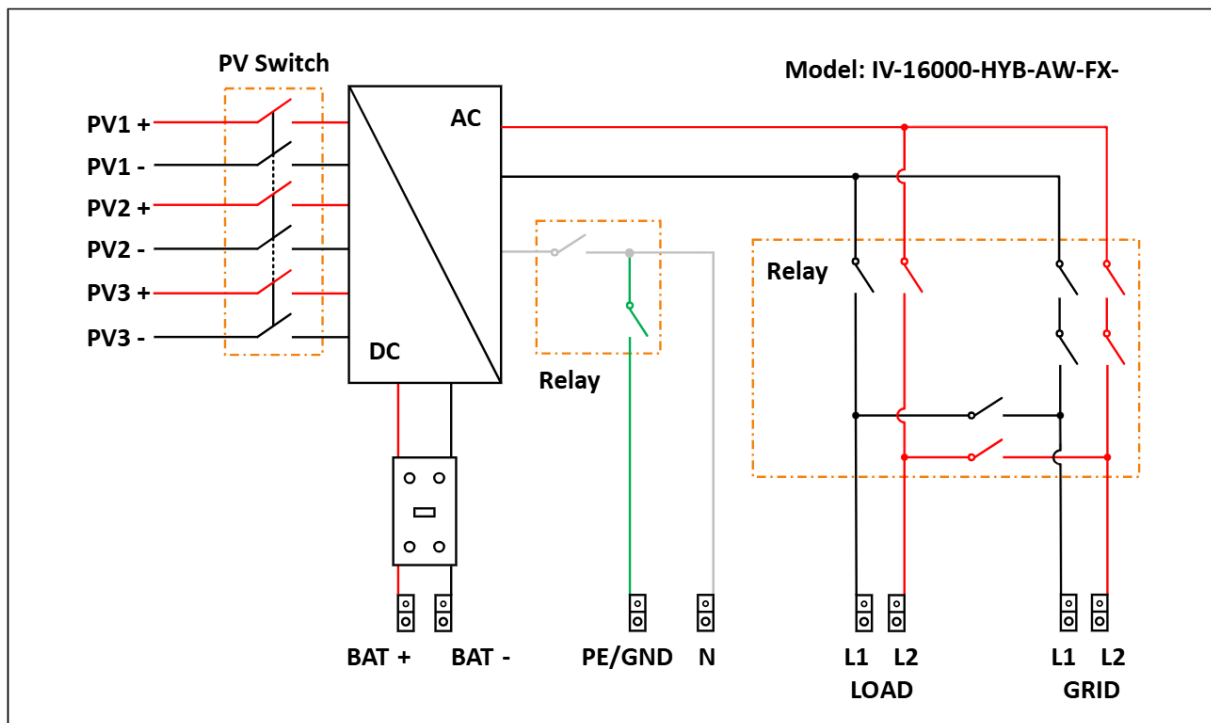

Mode Descriptions

Item	Mode	Time
1	Step Change in Load Test	The average open loop response time: 0.37s The maximum open loop response time:0.85s
2	Step Change in Generation Test	The average open loop response time:0.12s The maximum open loop response time:0.35s
3	Export limiting from all sources	The average open loop response time:1.92s The maximum open loop response time:2.00s
4	Import limiting from all sources	The average open loop response time:1.11s The maximum open loop response time:1.95s
5	ESS Operating Modes Unrestricted Mode	The average open loop response time:0.37s The maximum open loop response time:0.85s
6	ESS Operating Modes Export Only Mode	The average open loop response time:0.22s The maximum open loop response time:0.70s
7	ESS Operating Modes Import Only Mode	The average open loop response time:0.43s The maximum open loop response time:0.95s
8	ESS Operating Modes No Exchange Mode	The average open loop response time:0.12s The maximum open loop response time:0.35s
9	Export limiting from Energy Storage Systems	The average open loop response time:0.22s The maximum open loop response time:0.70s
10	Import limiting to Energy Storage Systems	The average open loop response time:0.43s The maximum open loop response time:0.95s

14. FIRMWARE UPDATES

14.1 FIRMWARE UPDATES VIA EG4® ELECTRONICS APP

Before updating firmware through the EG4® Monitor app, ensure the mobile device being used has enough battery life to last through the update. While the update is ongoing, do not close the application. Ensure the Wi-Fi dongle is securely connected and correctly configured before performing the following steps:

1. Open the EG4® Electronics app on a mobile device and select the “DOWNLOAD FIRMWARE” button.
2. Choose the correct firmware file (see eg4electronics.com for the most up-to-date files) and select “DOWNLOAD” on the right side to download the file to the mobile device.
3. Keep the app running and go to the mobile device’s Wi-Fi settings. Connect the mobile device to the dongle’s Wi-Fi network. The dongle’s network ID will be the same as the dongle’s serial number.
4. Return to the home screen of the app and select “LOCAL CONNECT.” Select the “Set” button on the bottom right side and proceed to the next step.
5. After completing step 4, the Local Set Interface will appear. Swipe to the bottom of the screen and select “UPDATE FIRMWARE.”
6. Choose the correct installation package in the dropdown box and select “UPDATE FIRMWARE” to begin the updating process.

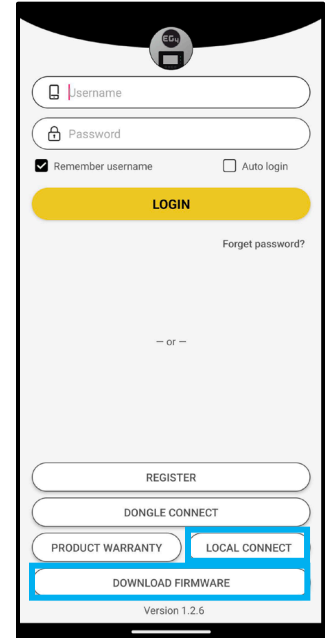

After selecting the “UPDATE FIRMWARE” button, the update will begin. Update progress can be viewed via the app. Once the update is completed, a notification will appear confirming that the firmware has been successfully updated. After successfully updating firmware, the inverter will restart itself. Make sure to update all inverters installed in the same ESS to the latest firmware version.

14.2 FIRMWARE UPDATE VIA MONITOR CENTER (WEBSITE)

1. Distributors and installers can update firmware by using the EG4® Electronics website monitoring system. Contact EG4® to make sure the files are correct.
2. Log in to the EG4® Electronics Monitor System. Select “Maintenance,” and then select “Remote Update.”
3. Choose the inverter to update and then select “Standard Update.” The Monitor Center will begin updating both firmware files in the inverter. The latest version of the firmware will be displayed in the bottom right window.

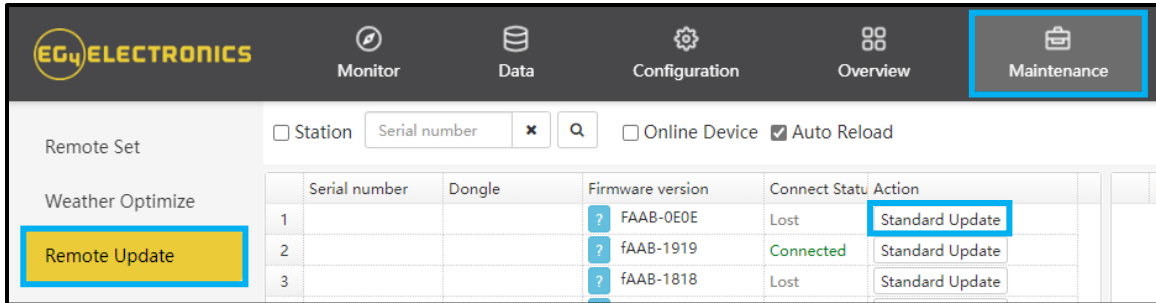

IMPORTANT:

Throughout the update, the inverter will automatically cycle power as it moves from one update to the next; however, if at any time an “Update Failed” alert appears, restart the full update from the first task. The “Update Failed” alert will only appear in the monitoring center. The software may need more than one attempt to update. If unable to successfully update the firmware, contact the distributor.





15. TROUBLESHOOTING AND MAINTENANCE

15.1 REGULAR MAINTENANCE

- Inspect the inverter every month to confirm nothing covers the inverter heat sink on the back of the inverter. If there is, shut down the inverter and clear the heat sink to restore proper cooling.
- Inspect the inverter every 3 months to verify if the operating parameters are normal and there is no abnormal heating or noise from all components in the system.
- Inspect the inverter every 6 months to check for any damaged cables, accessories, or terminals, and inspect the inverter itself.

15.2 LED DESCRIPTION

If a warning or fault occurs, users can troubleshoot according to the LED status description and the warning/fault information found in the “Event History” tab on the app or Monitor Center website.

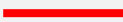
LED	DISPLAY	DESCRIPTION	ACTION
Green LED	Solid on 	Working normally	No action needed
	Flashing every 1 sec 	Standby	No action needed
	Flashing every 0.1 sec 	Firmware upgrading	Wait until the update is complete
Yellow LED	Solid on 	Warning, inverter may stop working	Needs troubleshooting
Red LED	Solid on 	Fault, inverter will stop working	Needs troubleshooting

Website

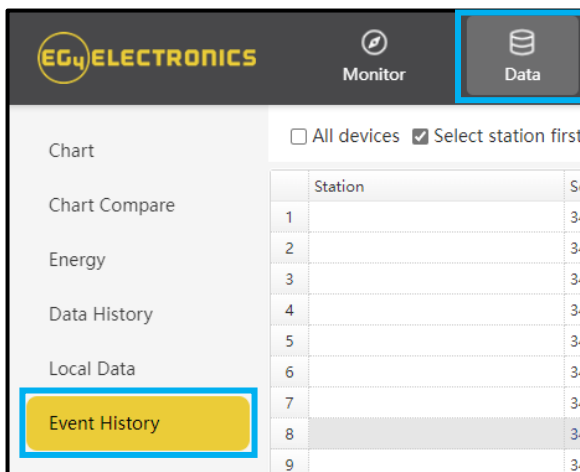

Mobile App

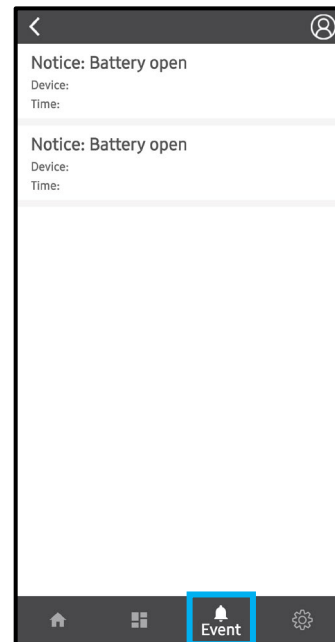

15.3 FAULTS AND ALARMS LIST

FAULT	MEANING	TROUBLESHOOTING
M3 Rx failure	M3 microprocessor fails to receive data from DSP	Restart the inverter. If the error persists, contact the supplier.
Model fault	Incorrect model value	
EPS short circuit	Inverter detected short-circuit on load output terminals	<ol style="list-style-type: none"> 1. Check if the L1, L2, and N wires are connected correctly at the inverter load output terminal. 2. Restart the inverter. If the fault persists, contact the supplier.
EPS power reversed	Inverter detected power flowing into load terminal	Restart the inverter. If the fault persists, contact the supplier.
Bus short circuit	DC Bus is short circuited	
Relay fault	Relay abnormal	

M8 Tx failure	DSP fails to receive data from M8 microprocessor	
M3 Tx failure	DSP fails to receive data from M3 microprocessor	
Vbus over range	DC Bus voltage too high	Ensure the PV string voltage is within the inverter specification. If string voltage is within range and this fault persists, contact the supplier.
EPS connect fault	Load terminal and grid terminal are wired incorrectly or reversed	Check if the wires on load terminal and grid terminal are wired correctly. If the fault persists, contact the supplier.
PV volt high	PV voltage is too high	Check if the PV string voltage is within the inverter specification. If string voltage is within range and this fault persists, contact the supplier.
Hard over curr	Hardware level over current protection triggered	Restart the inverter. If the fault persists, contact the supplier.
Neutral fault	Voltage between N and G is greater than 30V	Ensure the neutral wire is connected correctly.
PV short circuit	Short circuit detected on PV input	Disconnect all PV strings from the inverter. If the error persists, contact the supplier.
Temperature fault	Heat sink temperature too high	Install the inverter in a place with good ventilation and no direct sunlight. If the installation site is okay, check if the NTC connector inside the inverter is loose.
Bus sample fault	Inverter detected DC bus voltage lower than PV input voltage	Restart the inverter, if the fault persists, contact the supplier.
Inconsistent	Sampled grid voltage values of DSP and M8 microprocessors are inconsistent	
M8 Rx fault	M8 microprocessor fails to receive data from DSP	
Para Comm error	Parallel communication abnormal	<ol style="list-style-type: none"> 1. Check whether the connection of the parallel cable is loose. Connect the parallel cable correctly. 2. Ensure the PIN status of the CAN communication cable from the first to the end inverter is connected correctly.
Para master loss	No master in the parallel system	<ol style="list-style-type: none"> 1. If a master has been configured in the system, the fault will automatically be removed after the master works. 2. If a master has not been configured and there are only slaves in the system, set the master first. <p>Note: For a single-unit system, the role of the inverter should be set as "1 Phase Master."</p>
Para rating Diff	Rated power of parallel inverters are inconsistent	Confirm that the rated power of all inverters is the same.
Para Phase set error	Incorrect setting of phase in parallel	Confirm the wiring for the parallel system is correct. Once verified, connect each inverter to the grid. The system will automatically detect the phase sequence, and the fault automatically resolves after the phase sequence is detected. If the fault persists, contact the supplier.

Para sync loss	Parallel inverter fault	Restart the inverter. If the fault persists, contact the supplier.
----------------	-------------------------	--

ALARM	MEANING	TROUBLESHOOTING
Bat com failure	Inverter fails to communicate with battery	Check if the communication cable pinout is correct, and if the correct battery brand has been chosen. If all is correct but this alarm persists, contact the supplier.
AFCI com failure	Inverter fails to communicate with AFCI module	Restart the inverter. If the error persists, contact the supplier.
AFCI high	PV arc fault is detected	Check each PV string for correct open-circuit voltage and short-circuit current. If the PV strings are in good condition, clear the alarm.
Meter com failure	Inverter fails to communicate with the meter	Check if the communication cable is connected correctly and in good working condition. Restart the inverter. If the alarm persists, contact the supplier.
Bat Fault	Battery cannot charge or discharge	<ol style="list-style-type: none"> 1. Check the battery communication cable for correct pinout on both inverter and battery end. 2. Check if an incorrect battery brand has been chosen. 3. Check if there is a fault on the battery's indicator. If there is a fault, contact the battery supplier.
Fwm mismatch	Firmware version mismatch between the microprocessors	Attempt the firmware update again following the steps in section 14; if the fault persists, contact supplier.
Fan stuck	Cooling fan(s) are stuck	Contact supplier.
Trip by GFCI high	Inverter detected leakage current on AC side	<ol style="list-style-type: none"> 1. Check if there is ground fault on the grid and load side. 2. Restart the inverter. If the alarm persists, contact the supplier.
Trip by DCI high	Inverter detected high DC injection current on grid terminal	Restart the inverter. If the alarm persists, contact the supplier.
PV short circuit	Inverter detected a short circuit in PV input	<ol style="list-style-type: none"> 1. Check whether each PV string is connected correctly. 2. Restart the inverter. If the alarm persists, contact the supplier.
GFCI module fault	GFCI module is abnormal	Restart the inverter. If the alarm persists, contact the supplier.
Bat volt high	Battery voltage too high	Check whether the battery voltage exceeds 59.9V; battery voltage should be within inverter specification.
Bat volt low	Battery voltage too low	Check whether the battery voltage is under 40V; battery voltage should be within inverter specification.
Bat open	Battery is disconnected from inverter	Check the battery breaker or fuse. Reconnect as needed.
Off-grid overload	Overload on Load terminal	Check if load power on inverter LOAD terminal is within inverter specification.
Off-grid overvolt	Load voltage is too high	Load voltage is too high
Meter reversed	Meter connection is reversed	Check if the meter communication cable is connected correctly on the inverter and meter sides.

Off-grid dcv high	High DC voltage component on load output when running off-grid	Restart the inverter. If the alarm persists, contact the supplier.
RSD Active	Rapid shutdown activated	Check if the RSD switch is pressed.
Para phase loss	Phase losing in parallel system	Confirm that the wiring of the inverter is correct. If the master is set to 3-phase master, the number of parallel inverters must be ≥ 3 . (The grid input for each inverter should be connected correctly to grid L1, L2, L3.) If the master is set to 2x 208 master, the number of parallel inverters needs to be ≥ 2 . (And the grid input of each inverter should be connected correctly to grid L1, L2, L3.)
Para no BM set	Master is not set in the parallel system	Set one of the inverters in the parallel system as the master.
Para multi BM set	Multiple Primaries have been set in the parallel system	There are at least two inverters set as the master in the parallel system. Keep one master and set the other as slave.

16. STANDARDS AND CERTIFICATIONS

The EG4® FlexBOSS21 is cETL listed and complies with national and international standards for safety and reliability when connected to the grid.

Safety

- UL1741, SA, SB
- RSD NEC 2020:690.12 (PENDING)
- AFCI NEC 2020:690.11/UL1699B
- GFCI NEC 2020:690.41(B)
- CSA 22.2.107.1:2016 Ed. 4
- CSA 22.2.330:2017 Ed. 1

Grid Connection

- IEEE 1547.1:2020; IEEE 1547:2018
- Hawaii Rule 14H [HECO SRD IEEE 1547.1-2020 Ed. 2]
- California Rule 21 Phase I, II, III

EMC

- FCC Part 15 Class B (PENDING)

Outdoor Rating

- NEMA 4X

17. WARRANTY INFORMATION

For information regarding warranty registration on EG4® Electronics products, please navigate to <https://eg4electronics.com/warranty/> and select the corresponding product to begin the registration process.

18. CHANGELOG

V1.3.5

- Renamed “Max Altitude of Operation” to “Operating Altitude”
- Added QR Code for the Monitor Center Video.
- Modified external RSD type to Normally Closed

V1.3.4

- Added information regarding inverter derating for higher altitude installations to spec sheet

V1.3.3

- Added Warning note to section 7.6 page 29

V1.3.2

- Modified battery cable strip length in section 7.4
- Deleted most of section 11.
- Updated CT-Port picture.

V1.3.1

- Corrected minor typos
- Modified continuous output with battery only line to read as total instead of single legs in spec sheet

V1.3.0

- Updated the value for how many inverters can be paralleled

V1.2.9

- Added standby status to the table in section 15.2
- Added PV high protect value to spec sheet

V1.2.8

- Reformatted spec sheet and updated several values.

V1.2.7

- Updated “CT Typing” information in conjunction with UL3141 update. See Sect. 7.6.
- Created/Added sections 13 – “Power Control System”, 13.1 – “Export Limiting From All Sources (PEL), and 13.2 – “ESS Mode” to cover PCS information.
- Added spec: Battery charge/discharge ripple current: <5%
- Added additional step of setting inverter to standby before full shutdown

V1.2.6

- Updated third-party monitoring information

V1.2.5

- Removed redundant specification “Max continuous per line wattage” from specs

V1.2.4

- Added an asterisk to MPPT Operating Voltage Range line in spec sheet
- Added note after the spec sheet regarding MPPT Operating Voltage Range asterisk

v1.2.3

- Added Load Output Minimum Voltage line and value to spec sheet in section 1
- Corrected typo in section 7.4, battery cable requirements.

v1.2.2

- Minor formatting changes for easier readability
- Modified Note quick-part in section 7.4 for updated communication protocol information
- Modified verbiage in section 7.9 for External RSD
- Modified various sections for better readability based on latest EG4 Hybrid Inverter template
- Modified several images and diagrams based on the latest inverter model
- Reformatted Spec Sheet

- Added OLRT & Time to Steady State to Spec Sheet
- Modified several tables for better readability
- Modified unit dimensions in spec sheet and throughout the document
 - From 30.43 x 21.8 x 11.22 in. (773 x 556 x 285 mm)
 - To 30.43 x 22.28 x 11.22 in. (773 x 566 x 285 mm)
- Modified Section 8 from 140V startup voltage to 100V startup voltage

v1.2.1

- Modified weight of unit in spec sheet

v1.2.0

- Added Locked Rotor Amps (LRA) value to spec sheet
- Added French safety section
- Updated various monitoring center images

v1.1.9

- Removed (PENDING) from FCC Part 15, Class B

v1.1.8

- Added spacing requirements for above inverter to Section 5.2
- Modified optimal MPPT range in Section 4.2 from 120-450 to 250-450VDC

v1.1.7

- Modified Section 8.2 to have connectivity requirements for the dongle

v1.1.6

- Modified wire strip lengths for AC and PV connections

v1.1.5

- Modified cover photo
- Modified product images to show new logo
- Modified verbiage on Packing List

v1.1.4

- Modified model # format on cover page
- Modified CT Clamp ratio image in section 5.4 for more clarity
- Removed note stating multiple inverters needing a common battery bank.
- Modified ESS System Diagram image for more clarity

v1.1.3

- Added String Sizer Calculator link to section
- Modified cover image to reflect new logo & finish.
- Removed String Sizing Calculator QR codes and references
- Updated wire sizing and torque tables in Section 7.5
- Updated Idle Consumption in Section 1
- Updated Warranty Information
- Modified FCC Part 15, Class B to show (pending) in spec sheet

v1.0

- First revision of document completed



CONTACT US

support@eg4electronics.com

(903) 609-1988

www.eg4electronics.com