

EG4[®] FLEXBOSS18 HYBRID INVERTER

USER MANUAL



TABLE OF CONTENTS

1.	TECHNICAL SPECIFICATIONS	1
2.	ABBREVIATIONS	4
3.	SAFETY.....	5
3.1	SAFETY INSTRUCTIONS.....	5
3.2	IMPORTANT SAFETY NOTIFICATIONS	5
4.	SÉCURITÉ DE L'ONDULEUR.....	7
4.1	INSTRUCTIONS DE SÉCURITÉ	7
4.2	NOTIFICATIONS DE SÉCURITÉ IMPORTANTES.....	7
5.	PRODUCT OVERVIEW	9
5.1	PACKING LIST	9
5.2	FEATURES.....	10
5.3	OPERATION OVERVIEW	11
5.4	DIMENSIONS	14
5.5	STORING THE INVERTER.....	16
6.	GENERAL INSTALLATION	17
6.1	RECOMMENDED TOOLS	17
6.2	LOCATION REQUIREMENTS.....	18
6.3	MOUNTING THE INVERTER	19
6.4	CABLE INSTALLATION.....	22
6.5	INITIAL STARTUP & CONFIGURATION	32
7.	REMOTE MONITORING CONFIGURATION	36
7.1	DONGLE INSTALLATION	36
7.2	NEW USER ACCOUNT	37
7.3	EXISTING USER ACCOUNT	38
7.4	ENABLE APP NOTIFICATIONS	39
7.5	LOCAL MONITORING SETUP WITH THE EG4® MONITORING APP	41
8.	MONITORING CENTER OVERVIEW.....	42
8.1	WORKING MODES AND WEATHER OPTIMIZATION SETTINGS.....	42
9.	POWER CONTROL SYSTEM.....	49
9.1	EXPORT LIMITING FROM ALL SOURCES (PEL)	49
9.2	ESS MODE	51
10.	RAPID SHUTDOWN/ESS DISCONNECT	53
10.1	OVERVIEW.....	53
10.2	EXTERNAL RSD/ESS DISCONNECT.....	53
11.	WORKING WITH A GRIDBOSS.....	54
12.	INVERTER MAINTENANCE	55
12.1	START-UP & SHUTDOWN PROCEDURES.....	55
12.2	FIRMWARE UPDATES VIA THE EG4® ELECTRONICS APP	56
12.3	FIRMWARE UPDATE VIA MONITORING CENTER (WEBSITE).....	56
13.	INVERTER TROUBLESHOOTING.....	57
13.1	FAULT DEFINITIONS & TROUBLESHOOTING.....	58
13.2	ALARM DEFINITIONS & TROUBLESHOOTING	59
14.	DONGLE TROUBLESHOOTING	61
14.1	LEDS & BUTTON FUNCTIONALITY	61
14.2	DONGLE BOOTUP STEPS	61
14.3	CONNECTIVITY REQUIREMENTS.....	62
14.4	DONGLE PARAMETERS.....	62

14.5	TROUBLESHOOTING DONGLE NETWORK CONNECTION	63
14.6	NETWORK SECURITY	64
14.7	UPDATE DONGLE FIRMWARE USING APP	68
15.	STANDARDS AND CERTIFICATIONS	69
16.	CHANGELOG.....	70

1. TECHNICAL SPECIFICATIONS

INVERTER	
MODEL #	IV-13000-HYB-AW-FX-XX (XX is a number between 0-99)
CEC MODEL #	IV-13000-HYB-AW-FX-XX (240V) / IV-13000-HYB-AW-FX-XX (208V)
TYPE	Hybrid
DESIGN TOPOLOGY	High Frequency - Transformerless
AC SYSTEM	
NOMINAL VOLTAGE	120/240 or 208 VAC
FREQUENCY	50/60Hz
PHASE SUPPORT	1 ϕ
AC OUT	
NOMINAL OUTPUT VOLTAGE	120/240 or 208 VAC (L1/L2/N required)
MAX. CONTINUOUS OUTPUT	54A 13kW
MAX. CONTINUOUS OUTPUT – BATTERY ONLY	41.67A 10kW
MAX. CONTINUOUS OUTPUT – PV AND GRID @25C	41.67A 13kW
PEAK POWER	20000W (.5 sec) 15000W (1 sec) 13500W (1 min) 12500W (6 min) 11000W (12 min)
LOCKED ROTOR AMPS	195A
MAX. CONTINUOUS OUTPUT PER-LEG	41.67A 5kW
POWER FACTOR	.99 @ Full Load
MAX. PASS-THRU CURRENT FROM GRID	90A
REACTIVE POWER ADJUST RANGE	+0.8/-0.8
THDV	<5%
MAX. APPARENT POWER WITH BATTERY	10kVA
MAX. APPARENT POWER WITH PV AND GRID	13kVA
AC IN	
NOMINAL GRID VOLTAGE	120/240 VAC 120/208 VAC (L1/L2/N required)
MAX. GRID INPUT POWER (TO INVERTER W/O PASS-THRU)	41.67A 11kW
MAX. GRID CIRCUIT RATING (W/ PASS-THRU)	90A
MAX. INPUT SHORT CIRCUIT CURRENT RATING	10kA

BATTERY

NOMINAL VOLTAGE	51.2 VDC
OPERATING VOLTAGE RANGE	40 – 60 VDC
MAX. CHARGE CURRENT (DC AMPS)	208 ADC
MAX. DISCHARGE CURRENT (DC AMPS)	208 ADC
COMPATIBLE BATTERIES	See EG4 website

PV DC IN

NO. OF MPPTS	2
RATED CURRENT PER MPPT	26A (MPPT 1) 26A (MPPT 2)
INPUTS PER MPPT	3 2 (MPPT 1) 2 (MPPT 2)
SHORT-CIRCUIT CURRENT RATING PER MPPT	31A (MPPT 1) 31A (MPPT 2)
MAX. DC INPUT VOLTAGE	600 VDC
MPPT DC STARTUP VOLTAGE	200 VDC
MPPT FULL POWER VOLTAGE RANGE	250 – 440 VDC (360 VDC optimal)*
MPPT DC OPERATIONAL VOLTAGE RANGE	120 – 440 VDC
RECOMMENDED MAX. SOLAR ARRAY POWER (STC)	18kW
MPPT VOLTAGE HIGH PROTECTION	550 VDC**

*When sizing the system, it is best practice to follow the MPPT full power voltage.
 See <https://eg4electronics.com/wp-content/themes/hello-elementor/eg4-solar-panel-string-sizer/> for the EG4® String Sizing Tool.
 **The value at which the inverter will fault out to protect the MPPT from over voltage.

RESPONSE	
TRANSFER TIME (GRID TO BATTERY SWITCHING TIME)	20ms (Default) 10ms (Configurable)
OPEN LOOP RESPONSE TIME (OLRT)	<2 seconds
TIME TO STEADY STATE	<10 seconds
EFFICIENCY	
CEC WEIGHTED EFFICIENCY	97%
MAX. EFFICIENCY: PV TO GRID/LOAD	97%
MAX. EFFICIENCY: BATTERY TO GRID/LOAD	94%
MAX. EFFICIENCY: PV TO BATTERY	94.5%
MAX. EFFICIENCY: AC TO BATTERY	94%
IDLE CONSUMPTION (STANDBY MODE)	<60W @25°C
CONTROL & MONITORING	
DISPLAY	Optional EG4 FlexBOSS Screen Kit
USER INTERFACE	App/Web
REMOTE CONNECTIVITY	Wi-Fi, Cellular, and Ethernet (Wi-Fi dongle included by default)
ENVIRONMENTAL	
OPERATING TEMPERATURE RANGE	-13°F – 140°F (-25°C – 60°C)
STORAGE TEMPERATURE RANGE	-13°F – 140°F (-25°C – 60°C)
OPERATING HUMIDITY	0 – 95% relative humidity
OPERATING ALTITUDE	<6561 ft. (<2000 m)*
ENCLOSURE RATING	NEMA 4X
COOLING METHOD	Fans
NOISE	<50 dB @ 3 ft.
PHYSICAL SPECS	
DIMENSIONS (H × W × D)	30.43 × 22.28 × 11.22 in. (773 × 566 × 285 mm)
UNIT WEIGHT	115 lbs. (52 kg)
MOUNTING	Wall mount
MAX # OF INVERTERS IN PARALLEL	16
COMPLIANCE & SAFETY	
CERTIFICATIONS	UL1741, SA, SB; PCS CRD California Rule 21 Phase I, II, III; CSA 22.2.107.1:2016 Ed. 4; CSA 22.2.330:2017 Ed. 1; IEEE 1547.1:2020; IEEE 1547:2018 Hawaii Rule 14H [HECO SRD IEEE 1547.1-2020 Ed. 2]
EMISSIONS	FCC Part 15, Class B
WARRANTY	10 years**
SAFETY	Integrated DC disconnect, Reverse polarity protection, Output overvoltage protection varistor, Output over current protection, Ground fault monitoring, Grid monitoring, Pole sensitive leakage current monitoring unit, AFCI, RSD
PROTECTIONS	Arc-Fault Circuit Interrupter (AFCI) NEC 2020:690.11/UL1699B, Ground Fault Monitoring (GFDI) NEC 2020:690.41 (B), Rapid Shutdown (RSD) NEC 2020:690.12
BREAKER RATINGS	
BATTERY BREAKER	300A

*For installations above 2000 m, the inverter needs to be derated to specific values depending on the elevation. Refer to the “Inverter Altitude and Derating Usage Restrictions” guide by navigating to <https://eg4electronics.com/wp-content/uploads/2026/04/EG4-Inverter-Altitude-Derating-Usage-Restrictions.pdf> or by scanning the QR code below.

**For information regarding warranty registration on EG4® Electronics products, please navigate to <https://eg4electronics.com/warranty/> and select the corresponding product to begin the registration process.



2. ABBREVIATIONS

- AWG – American Wire Gauge
- A – Amps
- Ah – Amp hour(s)
- AC – Alternating Current
- AFCI – Arc-Fault Circuit Interrupter
- AHJ – Authority Having Jurisdiction
- kAIC – kilo-Amp Interrupting Capability
- ANSI – American National Standards Institute
- BAT – Battery
- BMS – Battery Management System
- COM – Communication
- CT – Current Transformer
- DC – Direct Current
- DIP – Dual In-line Package
- DOD – Depth of Discharge
- EG – Equipment Ground
- EGS – Equipment Grounding System
- EMC – Electromagnetic Compatibility
- EPS – Emergency Power System
- ESS – Energy Storage System
- E-Stop – Emergency Stop
- FCC – Federal Communication Commission
- GE – Grounding Electrode
- GEC – Grounding Electrode Conductor
- GFCI – Ground Fault Circuit Interrupter
- GFDI – Ground Fault Detector/Interrupter
- Imp – Maximum Power Point Current
- IEEE – Institute of Electrical and Electronic Engineers
- IP – Ingress Protection
- I_{sc} – Short-Circuit Current
- In-lbs. – Inch Pounds
- kW – Kilowatt
- kWh – Kilowatt-hour
- LCD – Liquid Crystal Display
- LFP – Lithium Iron Phosphate
- L1 – Line 1
- L2 – Line 2
- mm – Millimeters
- MPPT – Maximum Power Point Tracking
- mV – Millivolt
- N – Neutral
- NEC – National Electric Code
- NEMA – National Electrical Manufacturers Association
- NFPA – National Fire Prevention Association
- Nm – Newton Meters
- NOCT – Normal Operating Cell Temperature
- PC – Personal Computer
- PCB – Printed Circuit Board
- PE – Protective Earth
- PPE – Personal Protective Equipment
- PV – Photovoltaic
- RSD – Rapid Shut Down
- SCC – Standards Council of Canada
- SOC – State of Charge
- STC – Standard Testing Conditions
- UL – Underwriters Laboratories
- UPS – Uninterrupted Power Supply
- V – Volts
- VOC – Open-Circuit Voltage
- VMP – Voltage Maximum Power

3. SAFETY

3.1 SAFETY INSTRUCTIONS

International safety regulations have been strictly observed in the design and testing of the inverter. Before beginning any work, carefully read all safety instructions, and always observe them when working on or with the inverter. The installation must follow all applicable national or local standards and regulations.

Incorrect installation may cause:

- Injury or death to the installer, operator or third party
- Damage to the inverter or other attached equipment

3.2 IMPORTANT SAFETY NOTIFICATIONS



DANGER: Hazardous Voltage Circuits!

There are various safety concerns that must be carefully observed before, during, and after the installation, as well as during future operation and maintenance. The following are important safety notifications for the installer and any end users of this product under normal operating conditions.

1. **Beware of high PV voltage.** Install an external DC disconnect switch or breaker and ensure it is in the “off” or “open” position before installing or working on the inverter. Use a voltmeter to confirm there is no DC voltage present to avoid electric shock.
2. **Beware of high grid voltage.** Ensure the AC switch and/or AC breaker are in the “off” or “open” position before installing or working on the inverter. Use a voltmeter to confirm there is no voltage present to avoid electric shock.
3. **Beware of high battery current.** Ensure that the battery module breakers and/or on/off switches are in the “open” or “off” position before installing or working on the inverter. Use a voltmeter to confirm there is no DC voltage present to avoid electric shock.
4. **Do not open the inverter while it is operating to avoid electric shock and damage from live voltage and current within the system.**
5. Do not make any connections or disconnections (PV, battery, grid, communication, etc.) while the inverter is operating.
6. An installer should make sure to be well protected by reasonable and professional insulative equipment [e.g., personal protective equipment (PPE)].
7. Before installing, operating, or maintaining the system, it is important to inspect all existing wiring to ensure that it meets the appropriate specifications and conditions for use.
8. Ensure that the PV, battery, and grid connections to the inverter are secure and proper to prevent damage or injuries caused by improper installation.
9. Some components of the system can be very heavy. Be sure to utilize team-lift among other safe lifting techniques throughout the installation.



WARNING: TO REDUCE THE RISK OF INJURY, READ ALL INSTRUCTIONS!

All work on this product (system design, installation, operation, setting, configuration, and maintenance) must be carried out by qualified personnel. To reduce the risk of electric shock, do not perform any service other than those specified in the operating instructions unless qualified to do so.

10. Read all instructions before installing. For electrical work, follow all local and national wiring standards, regulations, and these installation instructions.
11. Make sure the inverter is properly grounded. All wiring should be in accordance with the National Electrical Code (NEC), ANSI/NFPA 70.
12. The inverter and system can inter-connect with the utility grid only if the utility provider permits. Consult with the local AHJ (Authority Having Jurisdiction) before installing this product for any additional regulations and requirements for the immediate area.
13. All warning labels and nameplates on the inverter should be clearly visible and must not be removed or covered.
14. The installer should consider the safety of future users when choosing the inverter's correct position and location as specified in this manual.
15. Keep children from touching or misusing the inverter and relevant systems.
16. **Beware!** The inverter and some parts of the system can be hot when in use. Do not touch the inverter's surface or most of the parts when they are operating. During operation, only the LCD and buttons should be touched.



WARNING!

Cancer and Reproductive Harm – See www.P65Warnings.ca.gov for more details.

DISCLAIMER

EG4 reserves the right to make changes to the material herein at any time without notice.

Please refer to www.eg4electronics.com for the most updated version of our manuals/spec sheets.

4. SÉCURITÉ DE L'ONDULEUR

4.1 INSTRUCTIONS DE SÉCURITÉ

Les réglementations internationales de sécurité ont été strictement observées lors de la conception et des tests de l'onduleur. Avant de commencer tout travail, lisez attentivement toutes les instructions de sécurité et respectez-les toujours lorsque vous travaillez sur ou avec l'onduleur. L'installation doit suivre toutes les normes et réglementations nationales ou locales applicables. Consultez l'autorité locale compétente et/ou le fournisseur d'électricité pour obtenir les permis et autorisations nécessaires avant l'installation.

Une installation incorrecte peut causer:

- Des blessures ou la mort de l'installateur, de l'opérateur ou d'un tiers
- Des dommages à l'onduleur ou à d'autres équipements connectés

4.2 NOTIFICATIONS DE SÉCURITÉ IMPORTANTES



DANGER: *Circuits à haute tension!*

Il y a divers problèmes de sécurité qui doivent être soigneusement observés avant, pendant et après l'installation, ainsi que pendant l'exploitation et la maintenance futures. Les notifications de sécurité suivantes sont importantes pour l'installateur et tout utilisateur final de ce produit dans des conditions normales de fonctionnement.

1. **Attention à la haute tension PV.** Installez un interrupteur ou disjoncteur externe de déconnexion DC et assurez-vous qu'il est en position "off" ou "ouvert" avant d'installer ou de travailler sur l'onduleur. Utilisez un voltmètre pour confirmer qu'il n'y a pas de tension DC présente afin d'éviter les chocs électriques.
2. **Attention à la haute tension du réseau.** Assurez-vous que l'interrupteur AC et/ou le disjoncteur AC sont en position "off" ou "ouvert" avant d'installer ou de travailler sur l'onduleur. Utilisez un voltmètre pour confirmer qu'il n'y a pas de tension présente afin d'éviter les chocs électriques.
3. **Attention au courant élevé de la batterie.** Assurez-vous que les disjoncteurs des modules de batterie et/ou les interrupteurs on/off sont en position "ouvert" ou "off" avant d'installer ou de travailler sur l'onduleur. Utilisez un voltmètre pour confirmer qu'il n'y a pas de tension DC présente afin d'éviter les chocs électriques.
4. **Ne pas ouvrir l'onduleur pendant qu'il fonctionne pour éviter les chocs électriques et les dommages dus à la tension et au courant en direct dans le système.**
5. Ne pas effectuer de connexions ou de déconnexions (PV, batterie, réseau, communication, etc.) pendant que l'onduleur fonctionne.
6. Un installateur doit s'assurer d'être bien protégé par un équipement isolant raisonnable et professionnel (par exemple, équipement de protection individuelle (EPI)).
7. Avant d'installer, d'exploiter ou de maintenir le système, il est important d'inspecter tous les câblages existants pour s'assurer qu'ils répondent aux spécifications et conditions appropriées pour l'utilisation.
8. Assurez-vous que les connexions PV, batterie et réseau à l'onduleur sont sécurisées et appropriées pour éviter les dommages ou les blessures causés par une installation incorrecte.
9. Certains composants du système peuvent être très lourds. Assurez-vous d'utiliser des techniques de levage en équipe parmi d'autres techniques de levage sûres tout au long de l'installation.



AVERTISSEMENT : POUR RÉDUIRE LE RISQUE DE BLESSURE, LISEZ TOUTES LES INSTRUCTIONS !

Tous les travaux sur ce produit (conception du système, installation, exploitation, réglage, configuration et maintenance) doivent être effectués par du personnel qualifié. Pour réduire le risque de choc électrique, ne réalisez aucun entretien autre que ceux spécifiés dans les instructions de fonctionnement, sauf si vous êtes qualifié pour le faire.

10. Lisez toutes les instructions avant d'installer. Pour les travaux électriques, suivez toutes les normes et réglementations locales et nationales de câblage, ainsi que ces instructions d'installation.
11. Assurez-vous que l'onduleur est correctement mis à la terre. Tous les câblages doivent être conformes au Code National de l'Électricité (NEC), ANSI/NFPA 70.
12. L'onduleur et le système peuvent se connecter au réseau électrique uniquement si le fournisseur d'électricité le permet. Consultez l'autorité locale compétente avant d'installer ce produit pour toute réglementation et exigence supplémentaire pour la zone immédiate.
13. Toutes les étiquettes d'avertissement et les plaques signalétiques sur l'onduleur doivent être clairement visibles et ne doivent pas être retirées ou couvertes.
14. L'installateur doit tenir compte de la sécurité des futurs utilisateurs lors du choix de la position et de l'emplacement corrects de l'onduleur, comme spécifié dans ce manuel.
15. Empêchez les enfants de toucher ou de mal utiliser l'onduleur et les systèmes pertinents.
16. **Attention !** L'onduleur et certaines parties du système peuvent être chauds lorsqu'ils sont utilisés. Ne touchez pas la surface de l'onduleur ou la plupart des pièces lorsqu'elles fonctionnent. Pendant le fonctionnement, seuls l'écran LCD et les boutons doivent être touchés.



AVERTISSEMENT !

Cancer et dommages reproductifs – Voir www.P65Warnings.ca.gov pour plus de détails.

DISCLAIMER

EG4® se réserve le droit de modifier le contenu de ce document à tout moment sans préavis. Veuillez consulter www.eg4electronics.com pour la version la plus récente de nos manuels/fiches techniques.

5. PRODUCT OVERVIEW

The EG4® FlexBOSS18 is a 120/240VAC split-phase, all-in-one, hybrid, sine wave inverter designed for the residential and small commercial markets. The FlexBOSS18 can utilize 18kW of DC (STC) solar PV on 2 MPPTs 26/26A and can utilize 10kW of power directly for loads from battery and 13kW with solar PV gain when connected to the grid. It can bypass 90A of utility power from its grid port to its load port. The FlexBOSS18 is a more affordable entry level cousin to the FlexBOSS21. Though it can perform as a standalone inverter, it has been designed to work optimally with EG4's GridBOSS power gateway. This unique pairing unlocks an even more robust feature-set and level of performance for the end user.

5.1 PACKING LIST

When the product is unpacked, the contents should match the list below:

Pictures for reference only.

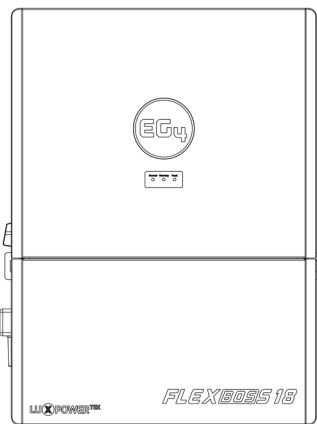

Hybrid Inverter

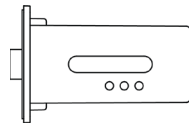

Wi-Fi Dongle

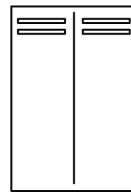

Wall Mount Template

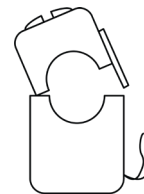

1" CT (x2)

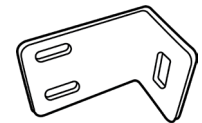

L Bracket (x2)

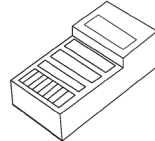

RJ45 Terminals (x4)

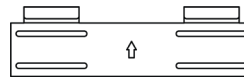

Mounting Bracket



Phillips Head M5x10 (x4)



Phillips Head M3x10 (x4)

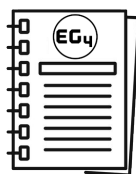

User Manual

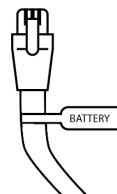

Battery Comm. Cable L=2m (orange)

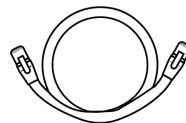

Parallel Comm. Cable L=2m (grey)



Sheet Metal/Wood Screw (x6)



Expansion Bolts (x6)

5.2 FEATURES

- FlexBOSS18 is a split-phase hybrid inverter that is able to operate on and off the grid.
- Designed for rural and suburban homeowners, and small commercial companies seeking energy savings and independence.
- Charge batteries and power loads simultaneously as users harness multiple power sources, including photovoltaic (PV), battery storage, as well as the grid.
- Supports up to 18kW of DC (STC) solar PV input while producing 13kW of continuous AC output at 240V when utilizing PV, even during battery charging, positioning it as an effective option for those looking to implement a robust Energy Storage System (ESS).
- Rated for 10kW continuous output without PV, and 13kW continuous output when utilizing PV and grid connection, with a power factor of 1.
- Incorporates MPPTs, a bi-directional DC-AC inverter, grid interaction, and battery connectivity. Supports closed-loop communications with all EG4® batteries and a wide selection of third-party batteries using CAN/RS485 protocols.
- Two MPPT solar charge controllers support a PV input of up to 600V with a nominal operating range of 250VDC – 440VDC. The two MPPTs allow for flexibility in paralleling strings at up to 26A each, for a total of 18kW of utilized solar power.
- Features a comprehensive list of certifications that ensure code compliance while offering additional safety and reliability. Fully compliant safety features include PV Arc Fault Protection, PV Ground Fault Protection, PV Reverse Polarity Protection, Pole Sensitive Leakage Current Monitoring Unit, Surge Protection, Integrated PV Disconnect, built-in RSD transmitter, and RSD/ESS disconnect initiator.
- Modular design allows for expansion, adapting to growing energy needs and securing future efficiency in solar investment. Supports up to 10 inverters in a parallel configuration.
- Users can monitor system performance and perform updates remotely via the EG4 Monitoring website and mobile app, ensuring control and flexibility.
- Full AC coupling, generator, and smart loads capabilities when used with GridBOSS.

5.3 OPERATION OVERVIEW

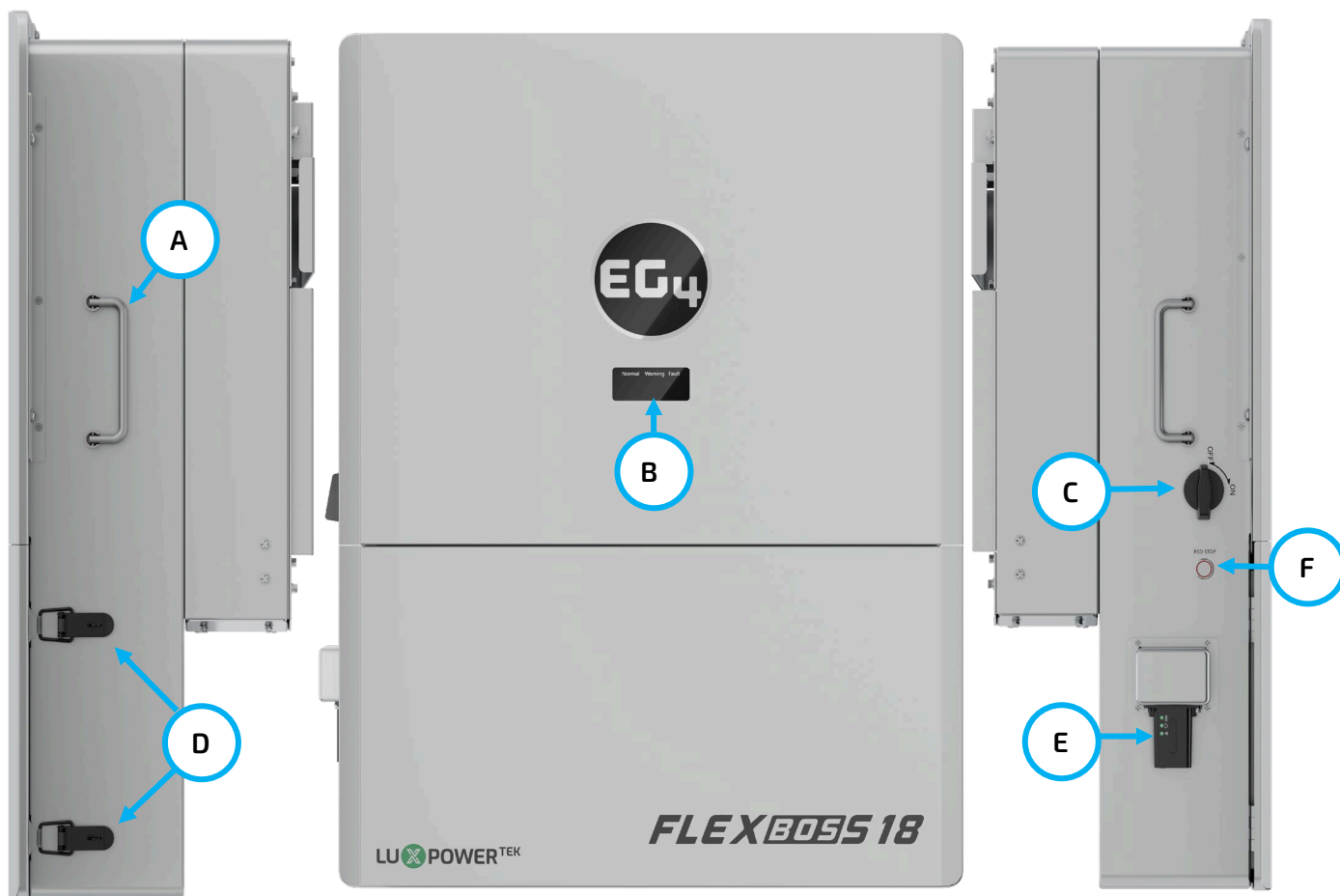

CALLOUT	COMPONENT	DESCRIPTION
A	Handles	Use for installation.
B	LED Panel	Used to monitor system status.
C	PV Disconnect Switch	Used to connect and disconnect power from solar panels.
D	Clasps	Use to open cable box.
E	Wi-Fi Dongle	Used to communicate with Monitor Center app or website.
F	RSD Button	Rapid Shut Down.

CABLE BOX OVERVIEW

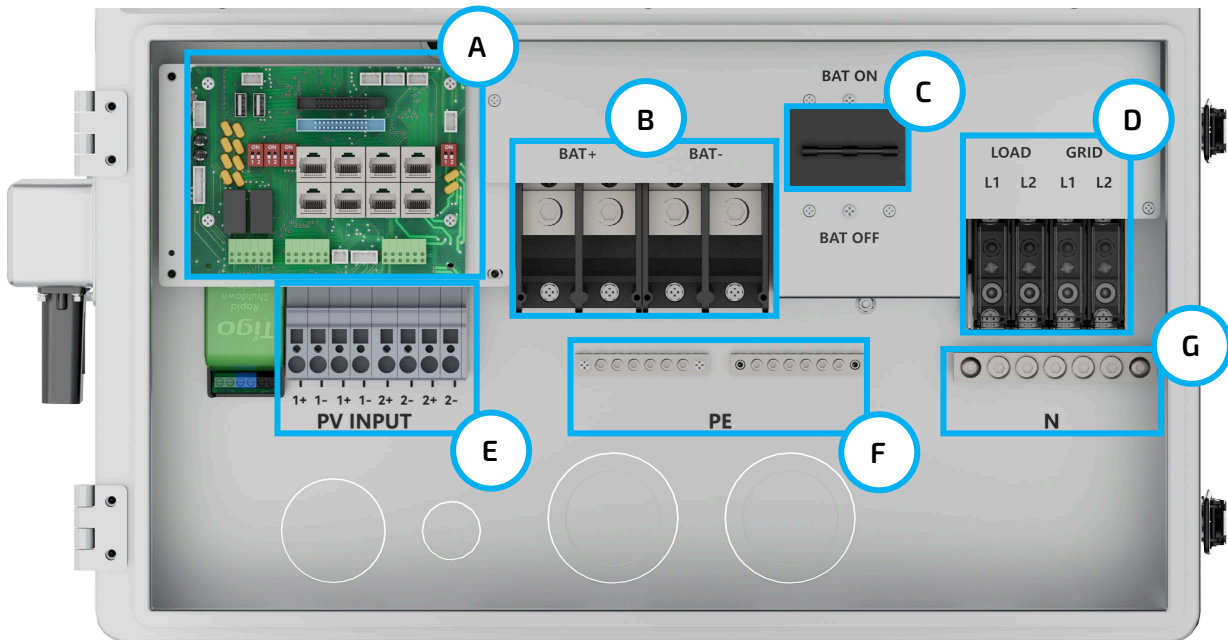

CALLOUT	COMPONENT	DESCRIPTION
A	Communication Board	Provides support and connections for inverter paralleling, CTs, battery communications, and external RSD.
B	Battery (DC) Connections	Used to connect battery cables.
C	Integrated Bonded Battery Breaker	Overcurrent protection for connected batteries.
D	AC Connections	Used for wiring AC power from the grid and to the loads.
E	PV Input	Used for wiring DC power from solar units to the inverter.
F	Protected Earth (Ground Busbar)	Used for ground wiring.
G	Neutral Busbar	Used for neutral wiring.

COMMUNICATION BOARD OVERVIEW

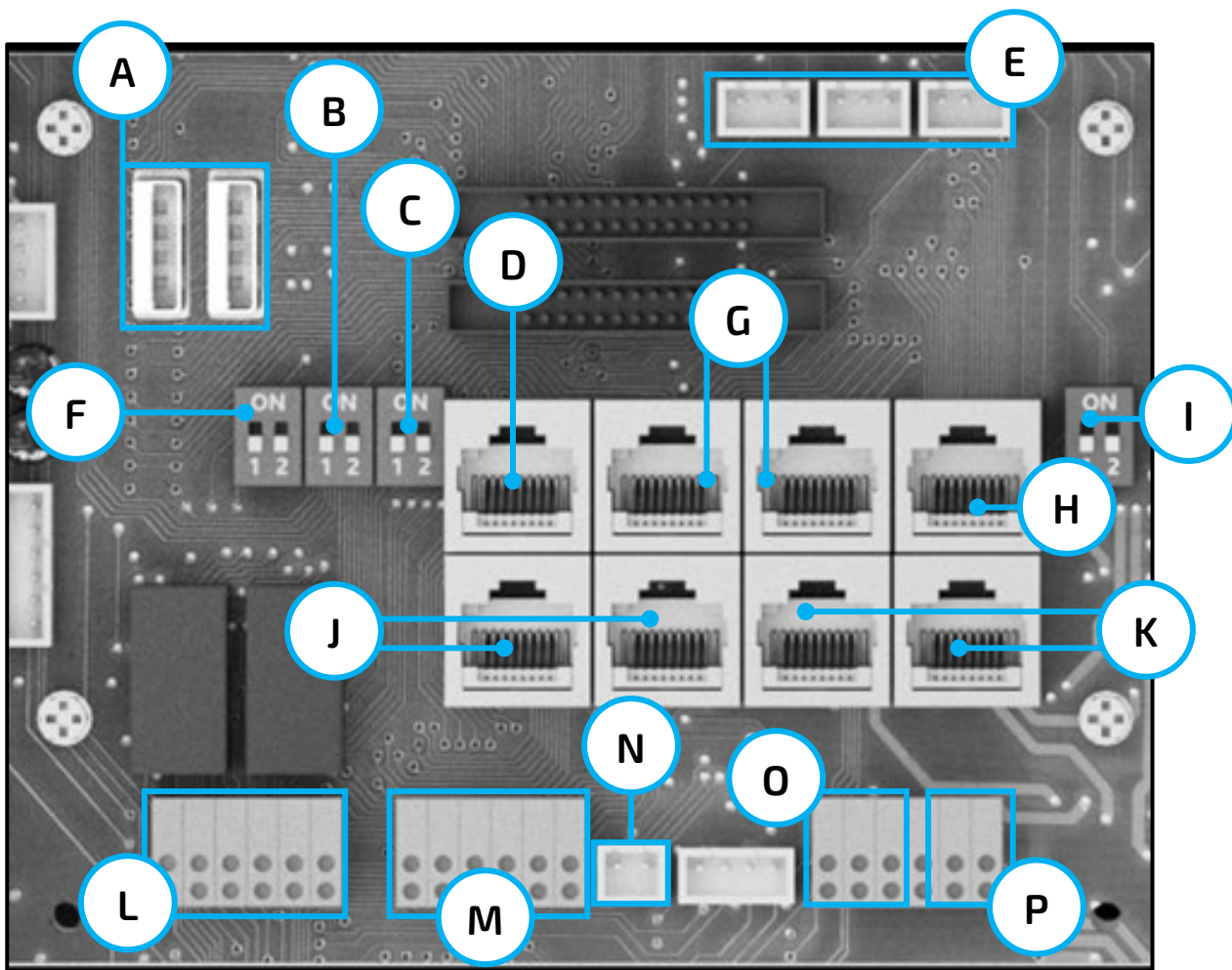

CALLOUT	DESCRIPTION
A	Reserved
B	Reserved
C	Parallel DIP Switches: Set DIP switches when using inverter in parallel.
D	Battery Communication Port (CAN & RS485)
E	Fan Power Supply
F	Reserved
G	Reserved
H	CT Interface Ports
I	Reserved
J	Reserved
K	Paralleling Communication Ports
L	DRY (NO, NC) Reserved
M	RSD Terminals
N	NTC: Connection for temperature sensor for lead acid battery.
O	Meter 485B & 485A. For meter communication.
P	DC power for customer use, max 1A.

5.4 DIMENSIONS

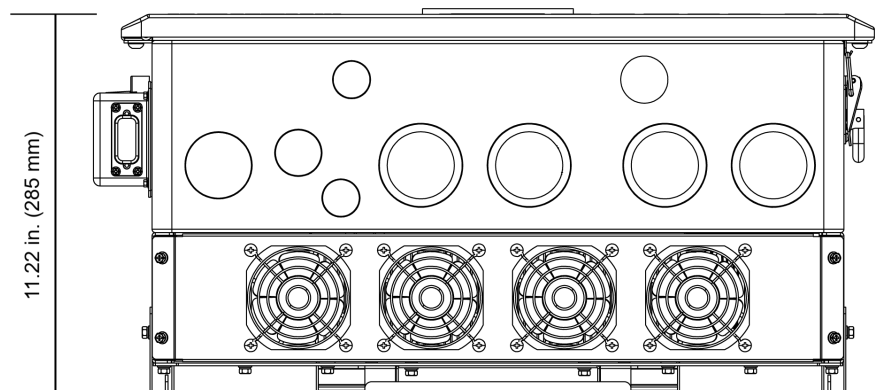
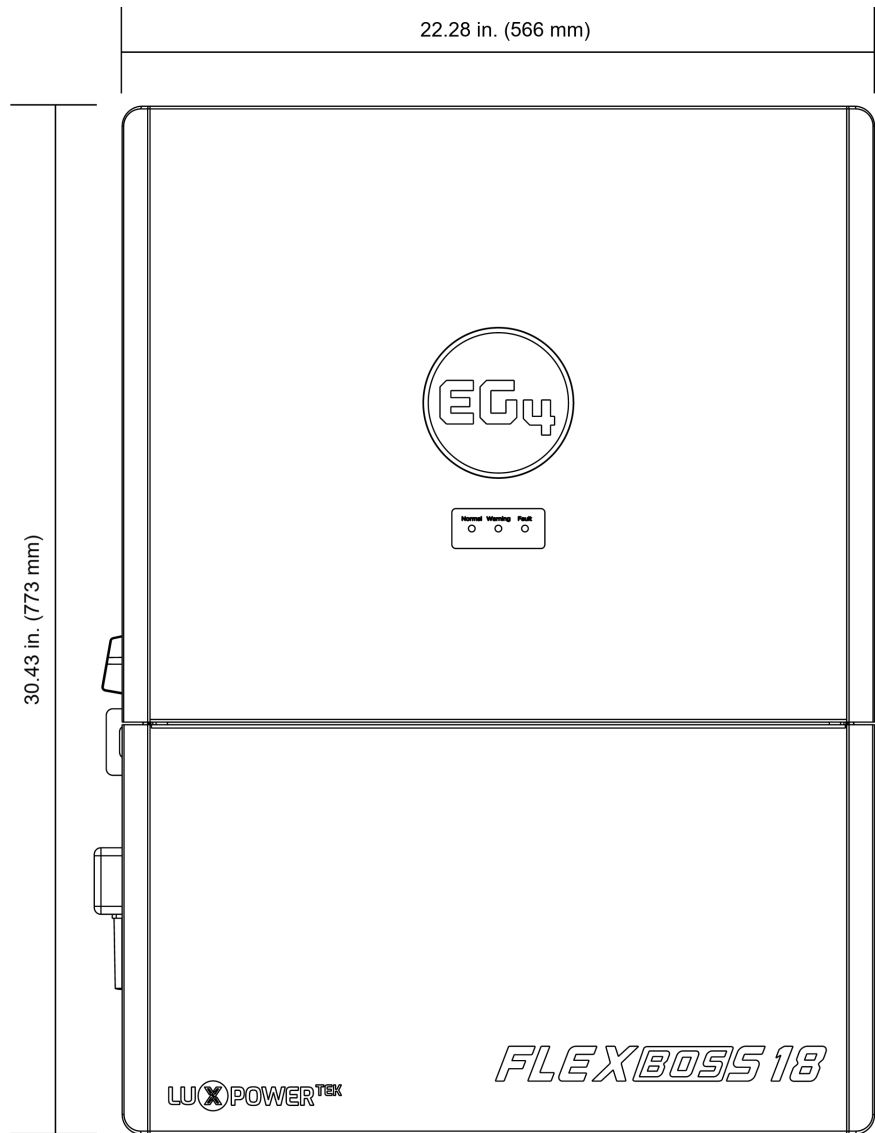

BOTTOM VIEW OF CABLE BOX KNOCKOUTS

U.S. NOM. TRADE SIZE	ACTUAL KNOCKOUT SIZE
3/4 in.	28.5 mm. (1.12 in.)
1 1/2 in.	50.5 mm. (1.99 in.)
2 in.	63 mm. (2.48 in.)

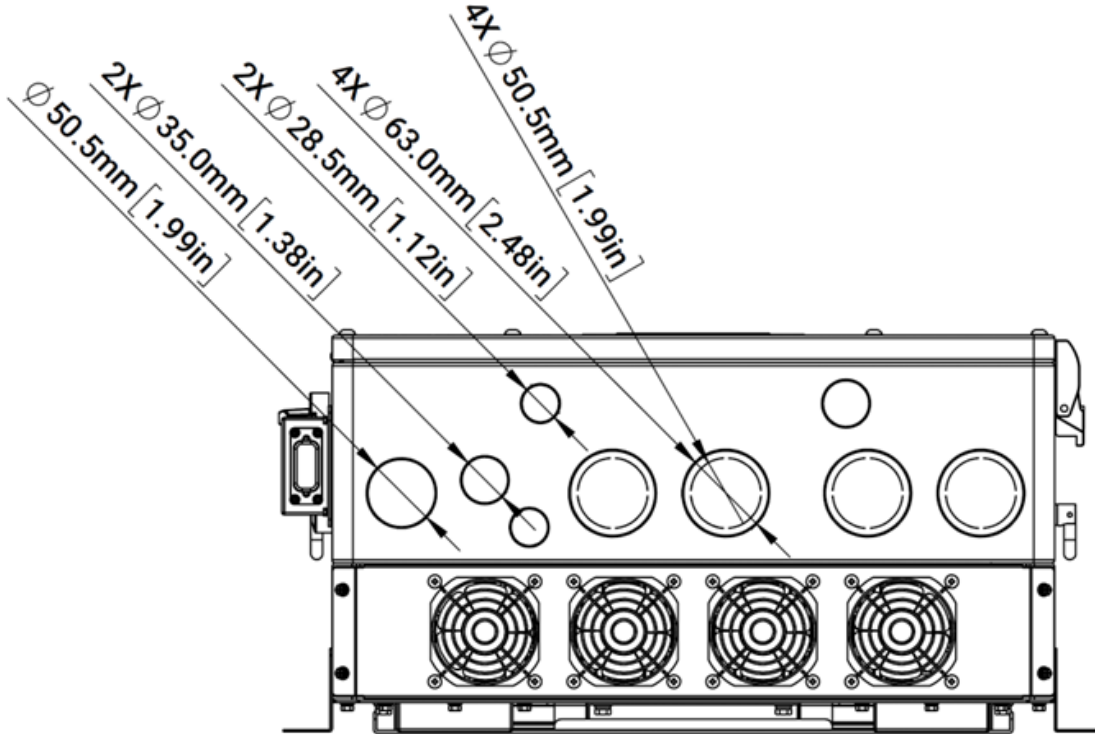

BACK VIEW OF CABLE BOX KNOCKOUTS

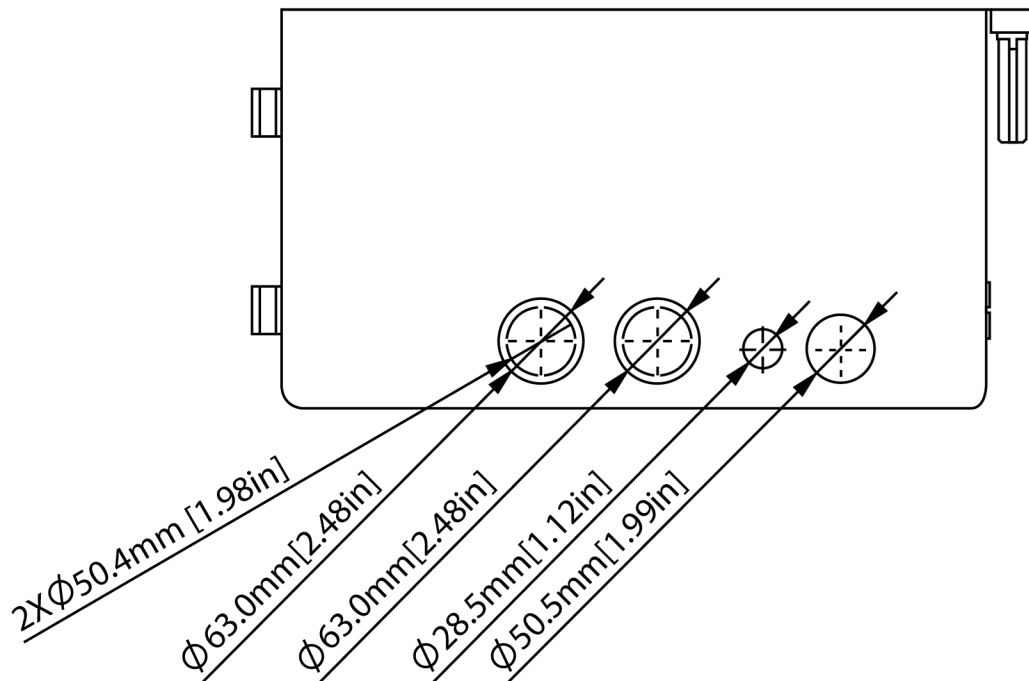

5.5 STORING THE INVERTER

If placing the inverter into storage before installation, keep the following factors in mind while selecting a storage location:



CAUTION:

- *The inverter and its components must be stored in its original packaging.*
- *The storage temperature should be within -13 – 140°F (-25 – 60°C) with humidity between 0 – 85%.*
- *The packing should remain upright with a maximum of 6 layers.*
- *Do not directly expose the inverter or its packaging to sunlight or rain and keep away from corrosive materials.*

Temperature <140°F (60°C)

Height <6.6 ft. (2m)

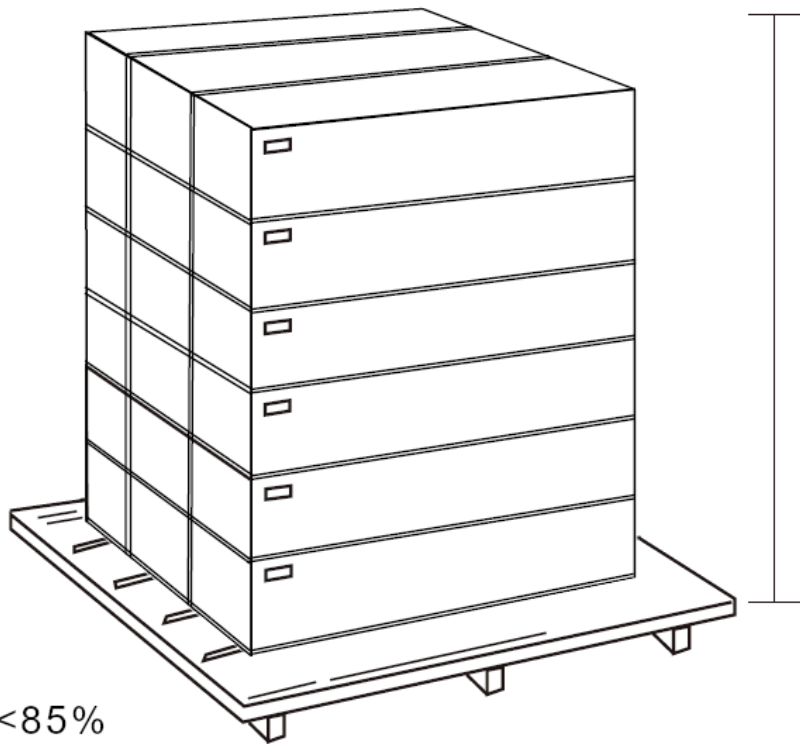

Humidity <85%

6. GENERAL INSTALLATION

This section provides detailed steps for installing and configuring the inverter. It is recommended to complete each section in order as listed below.

INSTALLATION STEPS

6.1 Recommended Tools

6.2 Location Requirements

6.3 Mounting the Inverter

6.4 Cable Installation

6.5 Initial Startup and Configuration

6.1 RECOMMENDED TOOLS



Safety Goggles



Dielectric Shoes



Gloves



Mask



Multimeter



Utility Knife

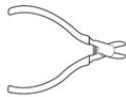

Wire Cutters

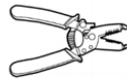

Wire Stripper

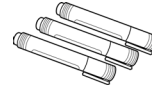

Marking Pen

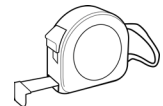

Tape Measure



Hex Wrenches



Screwdriver Set

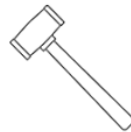

Hammer

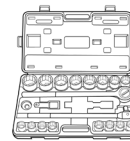

Socket Set



Drill & Bits

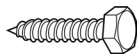

Wood Screws



Hand Truck

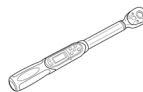

Torque Wrench



Level



Adjustable Pliers

6.2 LOCATION REQUIREMENTS

- The mounting wall should be strong enough to bear the weight (114 lbs. (52 kg)) of the inverter.

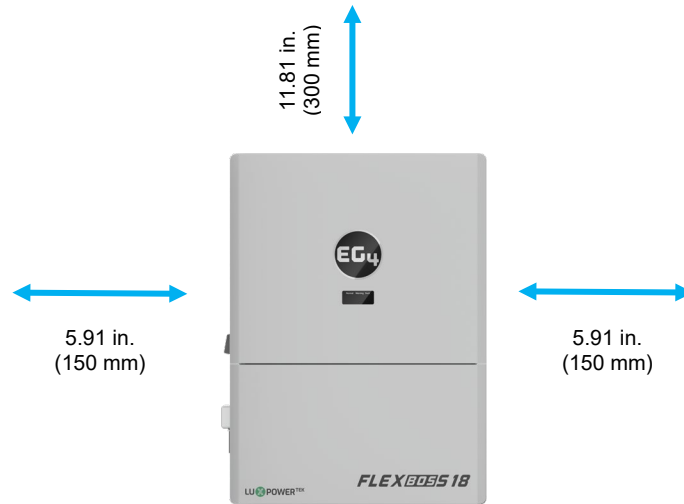

- Maintain the minimum clearances presented above for adequate heat dissipation.
- Avoid placing the inverter in direct sunlight, rain, or snow. Refer to the figure below and choose a well-covered site or in an indoor location to protect the inverter from the elements.
- The inverter should be installed upright on a vertical surface.

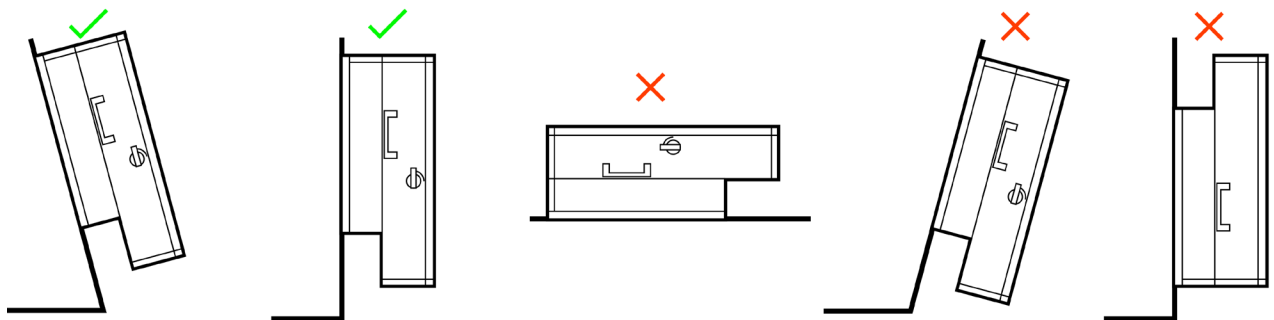
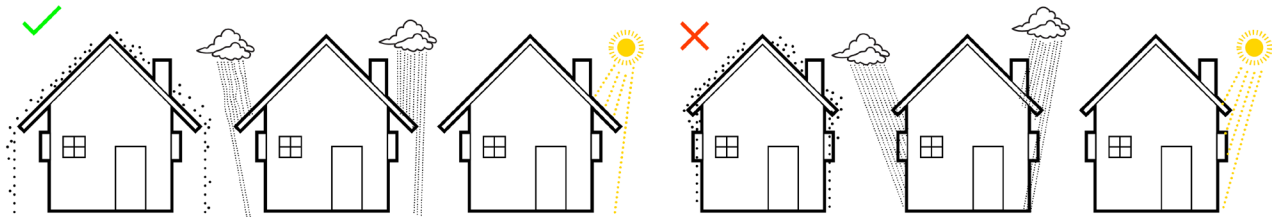

CAUTION:

Ensure there is at least 5.91 inches (150 mm) of space around the sides and 11.81 inches (300 mm) around the top of the inverter for heat to dissipate as designed. Ensure the inverter is mounted away from all combustible materials or else there is a risk of fire.

6.3 MOUNTING THE INVERTER

The inverter is designed to be wall-mounted on a solid, vertical, non-combustible surface such as brick or concrete. Two or more people may be needed to install the inverter due to its weight, using the team-lift technique. The slots on the mounting bracket can accommodate various stud spacings from 12 in. (305 mm) to 16 in. (406 mm).

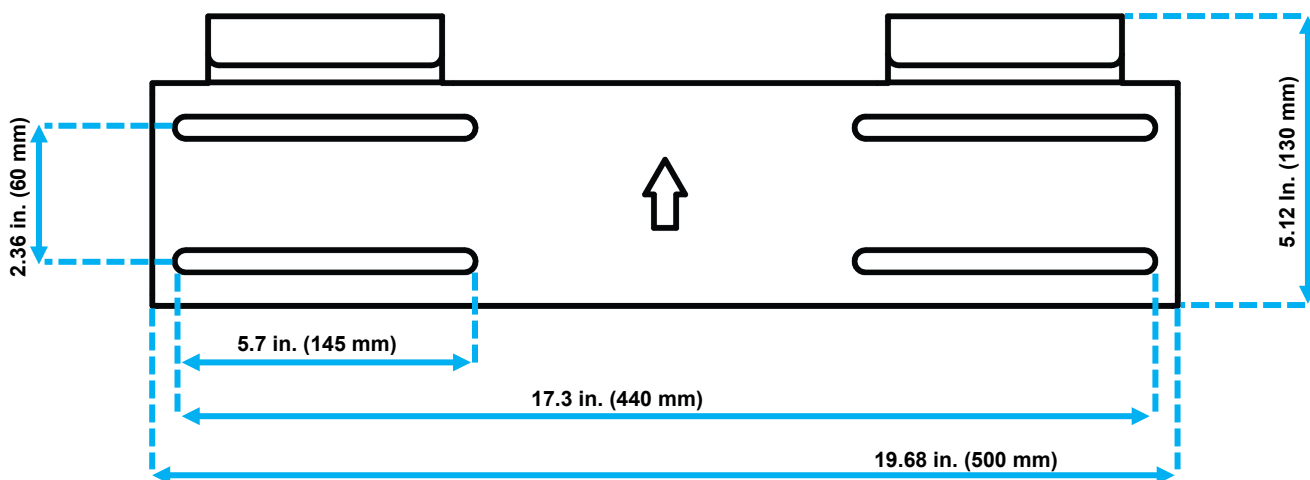

NOTE:

Ensure the mounting surface can support the weight of the inverter and maintains the proper spacing as shown in the images in section 6.2.

MOUNTING STEPS

1. Select a location for the inverter's final placement as described in section 6.2.
2. Use the wall mounting template and a marker to mark where the mounting bracket screws will be installed. Use a level to ensure the bracket will be installed parallel with the ground.

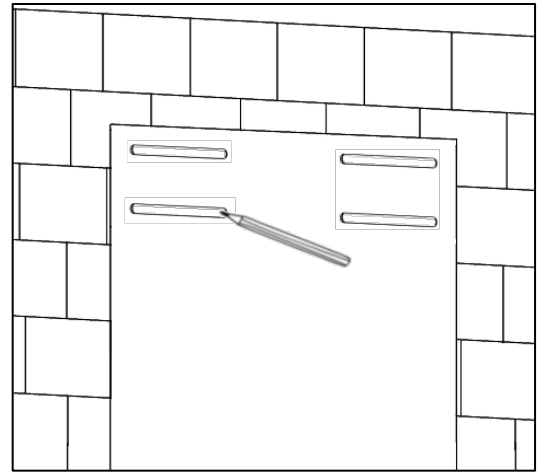

3. When installing the bracket to concrete or brick, drill 5/16 in (8 mm) diameter holes on the marks, making sure the holes are deeper than 2 in. (50 mm) when using the included expansion bolts. When installing the bracket to studs, verify the marked holes are over a stud to ensure the weight of the inverter is supported and drill a pilot hole sized appropriately for the screw diameter used. Ensure studs are spaced 12 – 16 in. (305 – 406 mm).

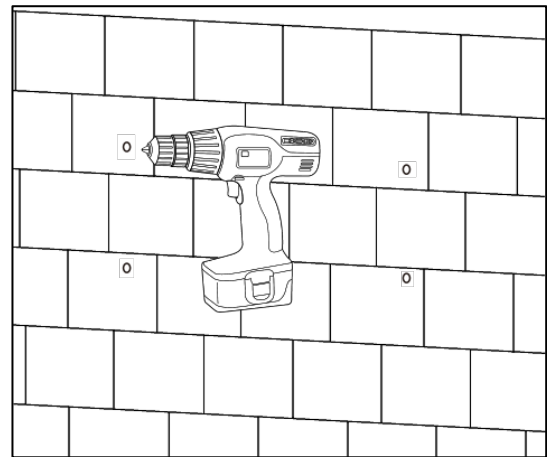

4. For concrete or brick installation, insert the expansion bolts into the drilled holes. Install the bracket to the wall, ensuring the arrow is pointing up. Use the corresponding nuts and washers (packaged together with the expansion bolts) to affix the bracket to the wall. For stud wall installation, use the proper screws and affix the bracket to the wall.

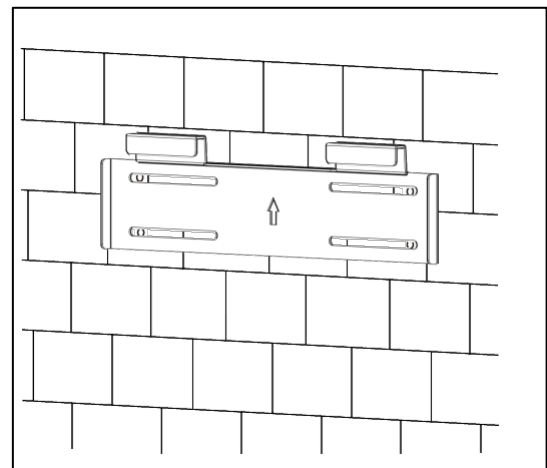

5. Using the team-lift technique, place the inverter onto the wall bracket, securing it to the wall.

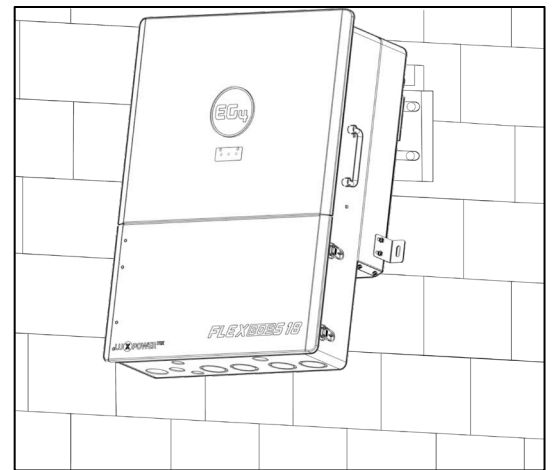

6. Temporarily mount the L bracket to the side of the inverter (located at the bottom, one on each side). Mark holes on the wall based on the hole location on the L bracket (repeat this step for both sides).

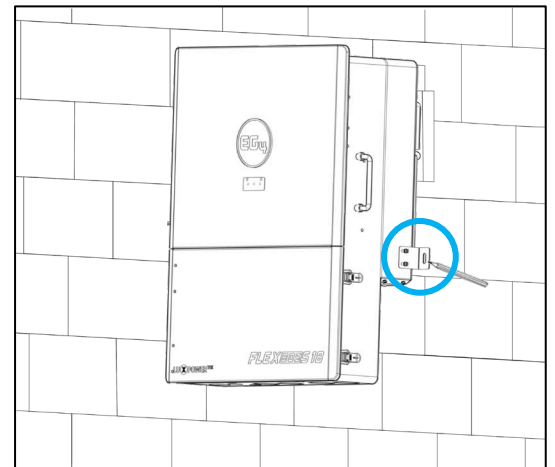

7. Remove the L bracket and drill a hole at the marking. Use the drill bit size based on the anchor type or screw size as directed in step 3 (repeat this step for both sides).
8. Attach the L brackets (one on each side) to the inverter and to the wall using the correct hardware. Once the bracket is secure, the wall installation is complete.

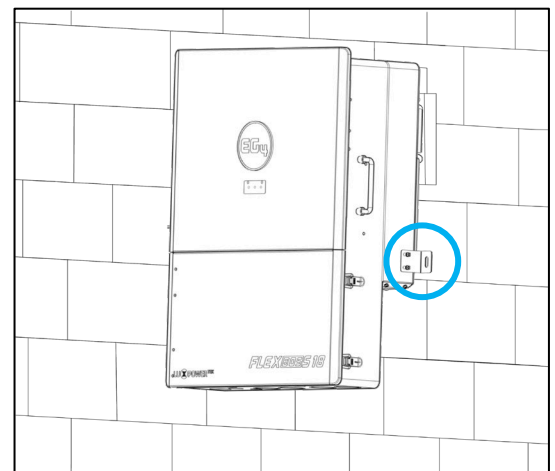

6.4 CABLE INSTALLATION

To expose the cable box area, open the bottom cover by releasing the clasps on the side of the inverter and removing the three screws on the internal wire box cover as indicated in the image below. Before connecting any wiring to the inverter, verify each wire is not carrying voltage using a multimeter.



BATTERY CONNECTIONS

The EG4® FlexBOSS18 comes equipped with two battery inputs with two positive and two negative points of connection. The two positive battery terminals are protected by a 250A breaker. This is to accommodate using parallel conductors as supplied with the WallMount battery series. It is designed to utilize four battery cables by using two sets of cables rather than resorting to larger cable sizes. For safe operation and regulation compliance, install a separate DC over-current protector or disconnect device between battery and inverter.

Cable Requirements*:

# OF CABLES PER POLE	TOTAL # OF CABLES	CABLE SIZE	TOTAL CABLE SET AMPACITY	MAX DISTANCE	TORQUE VALUES	INTEGRATED BATTERY BREAKER
2	4	1/0 AWG (53.5mm ²)	340A	16 ft.	Max. 230 in-lbs. (26Nm)	250A
2	4	2/0 AWG (67.4mm ²)	390A	21 ft.	Max. 230 in-lbs. (26Nm)	250A
2	4	3/0 AWG (85.0mm ²)	450A	26 ft.	Max. 230 in-lbs. (26Nm)	250A
2	4	4/0 AWG (107mm ²)	520A	33 ft.	Max. 230 in-lbs. (26Nm)	250A

**If longer cables are needed than what is shown in the chart, contact the distributor, consult a licensed electrician or see the National Electric Code (NEC) for additional information.*



NOTE:

The inverter needs a minimum of 300Ah of battery capacity to support the output specifications!

INSTALL STEPS:

1. Place all breakers in the OFF position before connecting or disconnecting any wires. Ensure that there is no voltage present with a multimeter.
2. Strip 3/5 in. – 4/5 in. (15 mm – 20 mm) of insulation from the cable end.
3. Route the battery power cable, connecting positive (red) to BAT+, and negative (black) to BAT-.
4. Fasten positive and negative battery cables to the mechanical terminals according to the markings with an M8 hex wrench. See torque values in the table above.
5. Verify the positive and negative battery cables are properly connected to the battery bank and the total amp hours meet or exceed the recommended 300Ah.

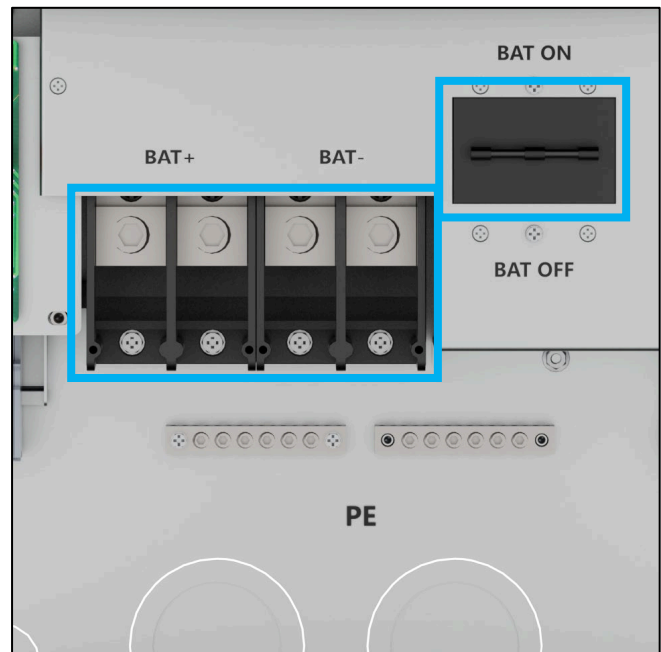



NOTE:

For best practice when installing multiple inverters in parallel, the battery bank must be connected to each inverter so the current can be evenly shared between each inverter. The positive cable from the battery bank to each inverter should be of equal length. If a busbar is used between the battery bank and the inverter, the cable from the busbar to each inverter should be equal lengths. Each negative cable should be of equal length as well. Using equal length positive cables and equal length negative cables supports equal amperage to each inverter. The positive cables and negative cables do not need to be the same length, only match cable length of the same polarity.

BATTERY COMMUNICATION CABLE CONNECTIONS:

- The communications cable is used with supported LiFePo4 batteries only. Closed loop battery communication is not supported for some 3rd party batteries nor with lead acid batteries.
- Use the included orange battery communication cable to connect the battery to the inverter. Put the inverter in standby mode to protect batteries until values are set.
- The battery communication port on the inverter is an RJ45 socket with the pinout for the RJ45 plug shown on the next page.
- The inverter supports both CAN and RS485 communication.
- After connecting the battery power and communication cables, go to the Monitor Center app or website. Select “Maintenance,” “Remote Set,” and choose the correct battery type under “Common Settings.”
- For closed-loop communication between the inverter and lithium batteries, choose “Lithium” as the battery type. For inter-battery communication and battery setup with EG4[®] batteries, refer to the respective battery manual.
- Select the “Lead-Acid” setting if the battery cannot communicate with the inverter. Ensure battery settings are within the battery’s specifications to prevent damaging the battery bank.

Model

Measurement (?)

Battery Type (?)

Lithium Brand (?)



NOTE:

If using EG4[®] LifePower4 V1 batteries in the system, a firmware update may be required for closed-loop communications. Navigate to <https://www.eg4electronics.com/> for the most recent updates and documentation or contact the distributor for this file. For communication with EG4 batteries, select “Lithium” under “Battery Type” and then select “1” under “Lithium brand”.

- **If using LifePower4 V1 batteries or RS485 communications, use “0:EG4” under “Lithium brand”.**

FOR LITHIUM BATTERIES:

- EG4® strongly recommends using closed-loop communications between the battery bank and inverter. Ensure the lithium battery being used is compatible with the inverter by visiting www.eg4electronics.com for an updated list of third-party batteries capable of closed-loop communication.
- If using multiple batteries modules with the inverter, the inverter communication cable must be connected to the master battery and the master inverter. Check the battery documentation for master and slave settings/definitions.

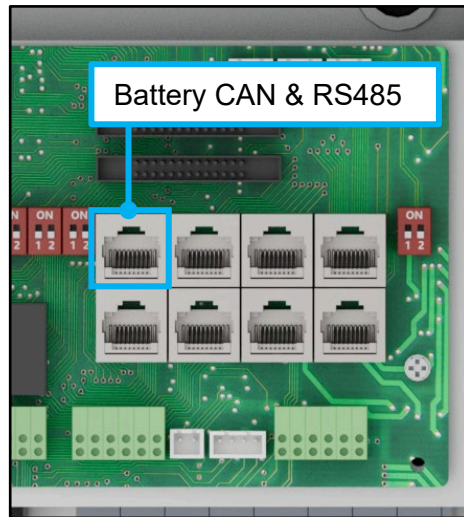

1 2 3 4 5 6 7 8	PIN	DESCRIPTION
1	1	BAT RS485B
2	2	BAT RS485A
3	3	NC
4	4	BAT CAN H
5	5	BAT CAN L
6	6	NC
7	7	NC
8	8	NC

FOR LEAD-ACID BATTERIES:

Closed-loop communication is not available with lead-acid batteries; however, a third-party external temperature sensor will enable the inverter to control the charge/discharge of the battery. Follow the battery's documentation to determine setting parameters and for additional information.

PV CONNECTIONS

When sizing PV wires, adhere to the following information*:

CABLE SIZE	MIN. INSULATOR VOLTAGE	MAX. AMPERAGE PER MPPT
10 AWG – 6 AWG (max.) (6 mm ² – 16 mm ²)	600V	MPPT 1: 26A
		MPPT 2: 26A

*Consult a licensed electrician or National Electric Code (NEC) to ensure that appropriate cable size is used due to various factors such as distance, operating voltage, and amperage.



IMPORTANT:

- Verify the lowest ambient temperature of the installation location. The rated VOC on the solar module nameplate is obtained at STC (77°F/25°C). As the ambient temperature drops, the solar module VOC increases. Ensure the maximum solar string voltage, corrected at the lowest temperature, does not exceed the inverter's maximum input voltage of 600V.
- It is recommended to install a PV disconnect switch between the inverter and PV modules.
- It is very important for system safety and efficient operation to use proper cable for PV module connection as shown in the table above.
- When connecting multiple inverters in parallel, a single string cannot be shared between inverters. Each string must be connected to its own MPPT.

PV INPUT DATA	DESCRIPTION	PARAMETER
PV Input Voltage Range	Range required for the unit to operate.	100 – 600 VDC
Unit Start-Up Voltage	Voltage required for the unit to power on	100 VDC
Load Output Minimum Voltage	Minimum voltage required to output power to loads	>140 VDC
MPPT Operating Voltage Range	Range where MPPT can track	120 – 440 VDC
Full Power MPPT Voltage Range	Range where the MPPT operates at max. capacity	250 – 440 VDC
Nominal MPPT Voltage	Voltage at which the MPPT operates most optimally	360 VDC
Max. Utilized Solar Power	Wattage the unit can utilize from the solar array	18kW
Recommended Max. Solar Input	Suggested PV power input to the device to utilize full 18kW of PV	21kW

INSTALL STEPS:

1. Ensure all breakers and disconnect switches are in the OFF position before connecting or disconnecting any wires. Use a multimeter to confirm there is no voltage present.
2. Strip off 1/2 in. – 2/3 in. (13 mm – 17 mm) insulation on the PV strings' positive and negative conductors.
3. Insert the conduit fitting into the opening for the PV connection and tighten it from the inside using the counter nut.
4. Route the PV conductors through the conduit fitting and into the inverter.
5. Secure the PV conductors in place into the inverter inputs by inserting a flathead screwdriver into the square and the conductor into the circular input. Verify that they are secured properly by lightly pulling on them.
6. Ensure the conduit and conduit fittings are fastened securely and the cable entry holes are sealed.

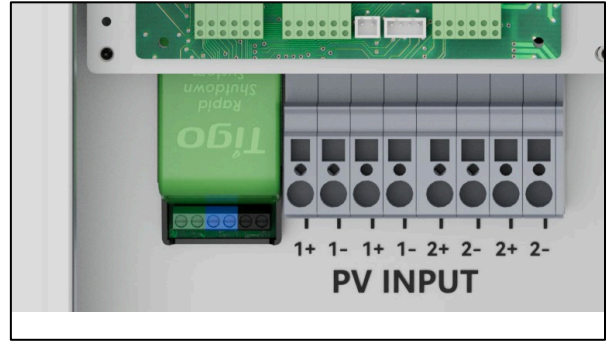

NOTE:

Use wire ferrules for the PV string conductors if using fine stranded wire.



NOTE:

*Navigate to the [EG4® Solar Panel String Sizer](https://eg4electronics.com/wp-content/themes/hello-elementor/eg4-solar-panel-string-sizer) tool for additional assistance:
<https://eg4electronics.com/wp-content/themes/hello-elementor/eg4-solar-panel-string-sizer>.*

STRING USAGE & SIZING

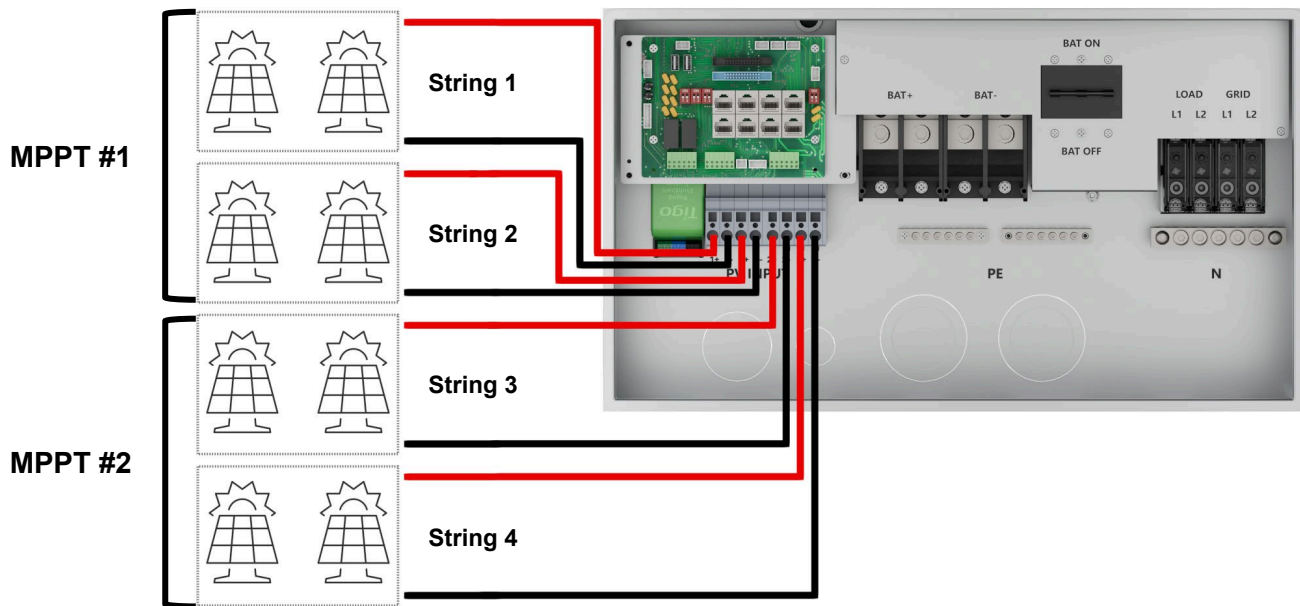

The image shown above represents full utilization of the 2 MPPTs. It is for representative purposes only.

- The maximum utilized solar input of the inverter is 18kW (DC).
- Each MPPT can utilize up to 26A of solar input each, with a maximum input of 31A. Exceeding 31A can damage the equipment.
- When both strings of the same MPPT are used, the inverter will parallel the two strings together. Each of the single strings cannot exceed 13A. This is to ensure the total amperage of the paralleled strings does not exceed 26A (Imp).
- Verify each string does not exceed the inverter's MPPT circuit ratings. Double check if the calculated VMP range is within the 120 – 440VDC MPPT circuit operating range. Consult a solar designer if needed.
- All panels on a string should face the same orientation and be exposed to roughly the same shading across the string. Consideration should be placed on string location and wiring order on the racking to minimize shading effects. One shaded module can disproportionately reduce output for the entire string. Optimizers can help counteract the effects of partial shading.
- When using both strings within an MPPT, both strings will ideally contain the same model, brand, and quantity of panels to make sure the two strings don't reduce the performance of one another.
- When solar modules are put in a series, the voltage multiplies by the number of modules and the amperage stays the same as each module.
- When equal solar strings are put in parallel, the amperage multiplies by the number of strings.
- If an external Overcurrent Protection Device (OCP) is needed, use OCP rated for 600 VDC at an amperage equal to the fuse rating of the panel. Please see solar module specifications for more information.

AC CONNECTIONS

When sizing AC wires, adhere to the following information*:

CONNECTION	MAX. BREAKER SIZE	MAX. CABLE SIZE	MAX TORQUE VALUES
Grid	90A	2 AWG (50 mm ²)	93 in-lbs. (10.5 Nm)
Load	90A	2 AWG (50 mm ²)	93 in-lbs. (10.5 Nm)
Ground	-	4 AWG (25 mm ²)	26 in-lbs. (2.9 Nm)
Neutral	-	2/0 AWG (70 mm ²)	44 in-lbs. (5 Nm)

*Consult installer to ensure that appropriate cable size is used due to various factors such as distance, operating voltage, and amperage.



NOTE:

- Always be sure to connect the AC Output ground wire to the Ground terminal before installing the AC Output L1 and L2.
- If using fine stranded wire, use ferrules to secure the connections.
- When installing multiple inverters in parallel, it is recommended to use equal length AC cables from each inverter to the main panel and from each inverter to the loads panel.
- If used in conjunction with GridBOSS, the Load port is not used. See the GridBOSS user manual for more information.

GROUND NEUTRAL BONDING

The information below describes the nature of the ground and neutral in the inverter and their relationship to the system. Always consult with a licensed electrician to ensure that the right configuration is being used:

- The neutral of the AC input and the AC output are common (known as a Common Neutral Architecture).
- The neutral line between the AC input and AC output is never disconnected.
- The inverter never creates a neutral-ground bond in any mode of operation.



CAUTION:

The system must have only one ground-neutral bond (typically the Main Bonding Jumper located at the service entrance main breaker).

INSTALL STEPS:

The FlexBOSS18 comes equipped with L1 and L2 terminals for AC input (labeled GRID) and output (labeled LOAD). It is designed to utilize up to 90A of input and up to 90A of output (via bypass). These terminals are not connected to a breaker; it is recommended to install a separate AC breaker between inverter and AC input power source. This will ensure the inverter can be disconnected during maintenance and fully protected from over current AC input. Consult a licensed electrician or check with the local AHJ for exact requirements for means of disconnect.

1. Before connecting or disconnecting AC wires, ensure all breakers are in the OFF position. Check that there is no voltage present with a voltmeter.
2. Strip off 2/5 in. – 3/5 in. (10 – 15 mm) insulation from the AC cables.

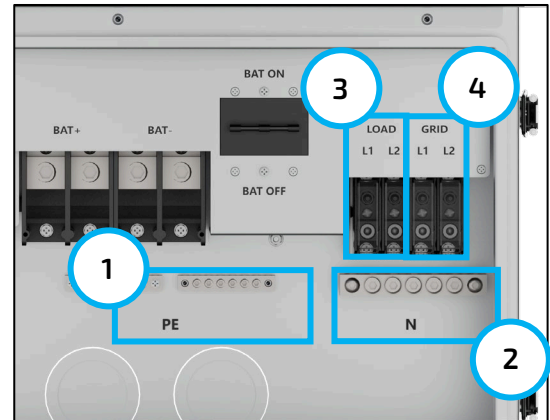

NOTE:

Use wire ferrules if the cables are made of fine stranded wires.

3. Connect the AC ground wire to the ground bus (Callout 1).
4. Fasten the neutral wire into the neutral bus (Callout 2).
5. Secure the AC wires into their respective mechanical lugs (Callouts 3 and 4). Connect line 1 to L1, and line 2 to L2. Torque to the specifications in the chart above
6. Check that the cables are connected properly. Take appropriate measures to ensure the conduit and conduit fittings are properly secured and seal the cable entry holes.



CAUTION:

- Do not misconnect the grid input and loads output connections. This may cause damage to the inverter and other attached devices.
- Be sure to connect the AC wires with the correct polarity. If the L and N wires are reversed, it will cause the inverters to go into fault and may damage the inverter when the inverters are working in parallel operations.

CT CONNECTION

To measure the power imported from and exported to the grid, a pair of CTs or one three-phase meter must be installed at the service entry point in or near the main service panel. Two (2) CTs are provided with each inverter with a 300A rating.



WARNING:

Do not install the CTs when using this inverter with EG4® GridBOSS. If installed, the inverters current output can show false readings in EG4 Monitor Center.

CT Type:

Model: CTSA024-300A/100mA **Technical Specification:** 240V/208V, 300A/100mA

CT PORT PIN DEFINITION:

The CT interface for the two (2) CT connections is an RJ45 port. The two (2) CTs come with a premade plug that can be connected directly to the RJ45 port.

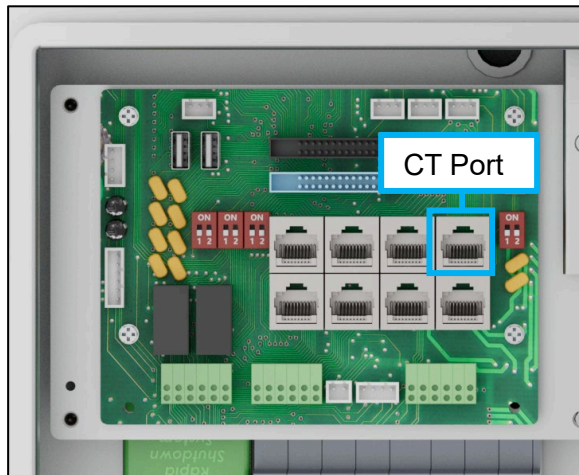

PIN	DESCRIPTION
1 – 4	Reserved
5	CT2N
6	CT2P
7	CT1N
8	CT1P

Refer to the connection diagram below for the correct position of the CTs. Clamp the 2 CTs onto the L1 and L2 wires at the service entry point in the main service panel as close to the meter base as possible.

The arrows on the CTs must point toward the inverter and should be placed on the proper line based on their number. (CT 1 for L1, CT 2 for L2)

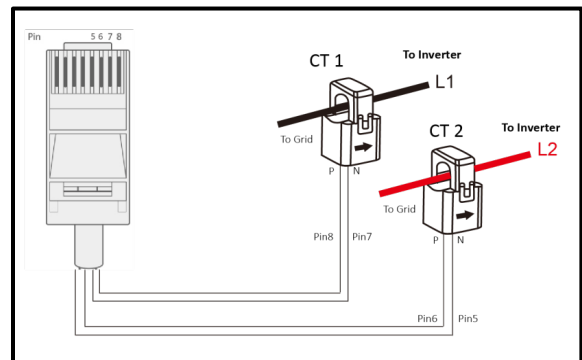

CT CLAMP RATIO:

The inverter supports three ratios of CT clamps: 1000:1, 2000:1, and 3000:1. The included CTs are 3000:1.

If using a 3rd party CT, ensure the CT ratio is of the supported types. Be sure to select the correct CT ratio setting on the inverter.

Black – L1
 Red – L2
 Grey – Neutral
 Blue – Communication Cable

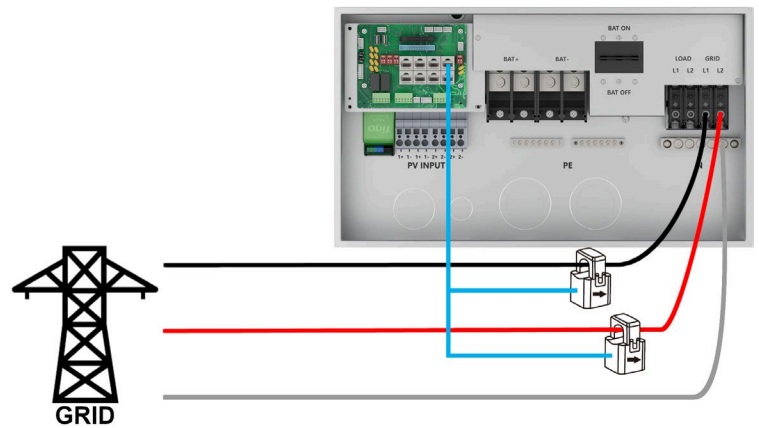

EXTENDING THE CT CLAMP CABLE:

The CT wires can be extended with a standard CAT5 (or up) ethernet cable if they are not long enough. An RJ45 adapter is needed for the extension. The CT wires can be extended up to 300 ft. (around 90 m).



6.5 INITIAL STARTUP & CONFIGURATION

This section describes powering on a single or multiple inverters for the first time, including the related configurable settings via the mobile app or website. These settings can be configured only after a user account is created. Follow the steps in section 7.2 to create a new user account and then section 8 for using Monitor Center.



WARNING:

If more than one inverter is installed and interconnected as one Energy Storage System (ESS), follow the steps listed under “Multiple Inverters” on the following page. Each inverter must be properly configured to work together in parallel mode before outputting current onto the Load ports. If the proper configuration is not followed, damage could be caused to the inverter and other connected devices.

SINGLE INVERTER

1. Ensure each inverter circuit breaker is in the open (OFF) position. No voltage should be coming in or out of the inverter.
2. Using a multimeter, check the following:
 - a. Check the battery bank voltage is within operating range at the inverter DC breaker, or the external DC disconnect.
 - b. Check the PV voltage is within operating range at input connections of the inverter.
 - c. If using AC input, double check each hot line to neutral connection supplying power to the inverter to ensure voltage is in operating range of the inverter.
3. Upon confirming all voltages are within the inverter’s operating range, set the inverter battery breaker to the closed (ON) position. If equipped, close the external battery breaker installed between battery bank and inverter.

- Power on each battery one at a time, starting with the master, then each additional battery in ~5 second intervals. This should power up the unit.
- Check the front LED display to confirm unit powers on.

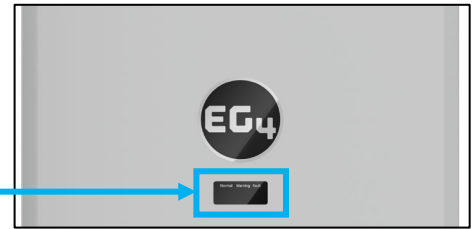

- Check for warnings and errors using the LED panel on the front face of the unit of the unit. If the inverter shows “normal” move ahead to the next step.
- Move the external PV isolator switch to the closed (ON) position (if equipped). Set the PV switch on the side of the inverter to the closed (ON) position. Again, check for errors or warnings via the LED indicators on the front display panel and/or the monitoring center. If the inverter shows “normal” move ahead to the next step. The image below represents the “normal” status in the monitoring center.

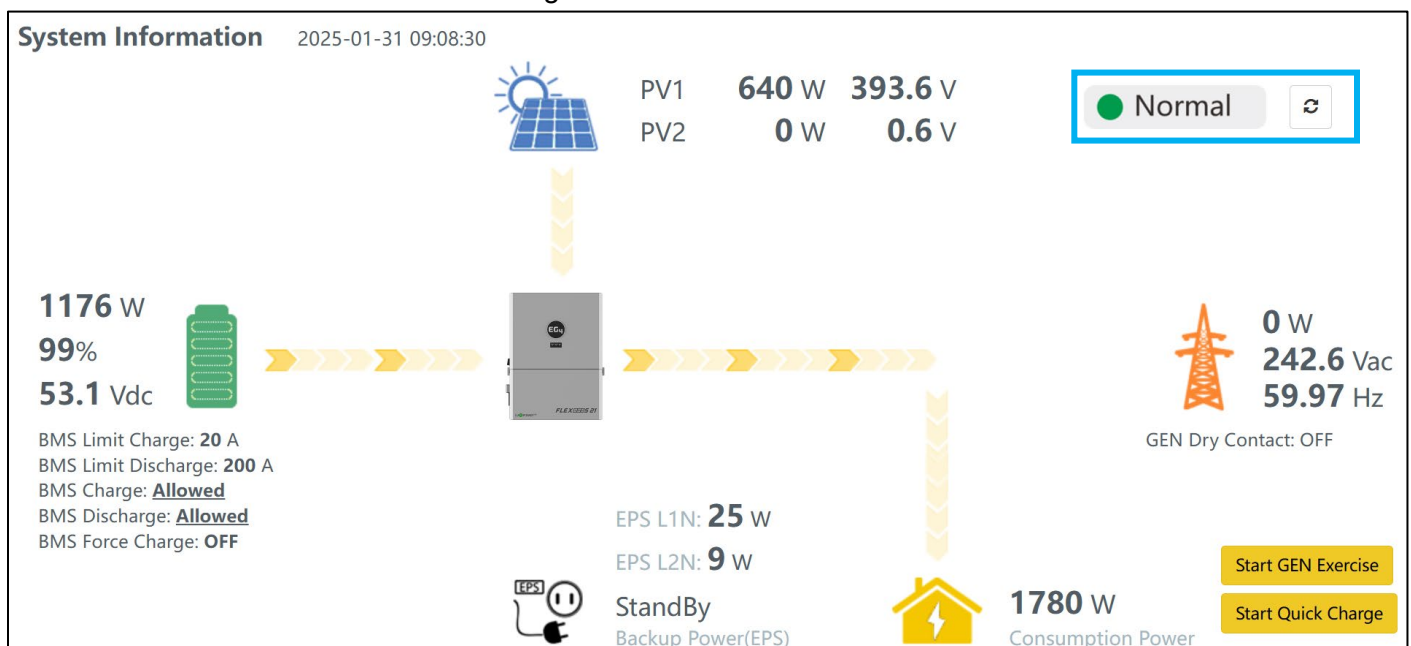

- If using grid input, set the external breaker between input panel and inverter to the closed (ON) position. Next, move the inverter GRID breaker to the closed (ON) position. This should provide AC power to the inverter. Again, check for errors or warnings. If the inverter shows “normal” proceed to the next step.
- Verify the loads panel is ready to accept current from the inverter. Set the input breaker at the loads panel to the closed (ON) position.
- Set the output breaker on inverter to the closed (ON) position. The inverter should now be providing current to the loads panel.

MULTIPLE INVERTERS

The EG4® FlexBOSS18 supports up to 10 units connected in parallel to reach a capacity of up to 130kW. To successfully connect inverters together in a parallel configuration, verify the following:

- A single string of solar panels cannot be shared between inverters.
- In order to support proper ventilation and cooling, the inverters are installed with required clearances as shown in section 6.2.



CAUTION:

Only use the provided parallel cable when connecting the inverters together. Using the wrong cable could cause hardware damage. If a longer cable is required, see image below for more information or contact the distributor.

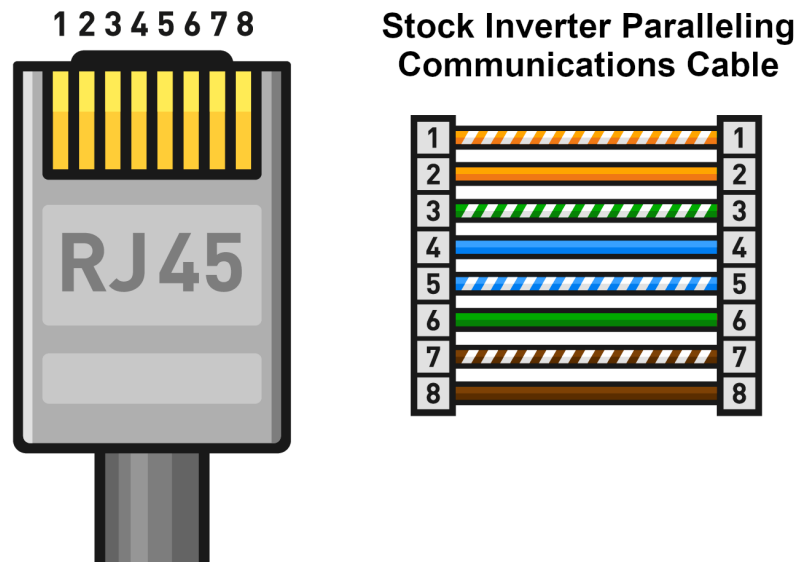

1. Set the CAN communication PIN to ON position for the first and the last inverter. Set the PIN to the OFF position for any inverters between the first and last. Both switches in the “ON” position translates to address 1. Both switches in the “OFF” position translates to address 0.
2. Install the included parallel cable (grey in color) to the parallel port on each inverter as shown in the diagram below. If only two inverters are installed only one parallel cable is required. Two parallel cables will provide redundancy in the event one cable is disconnected or stops working.

See image below:

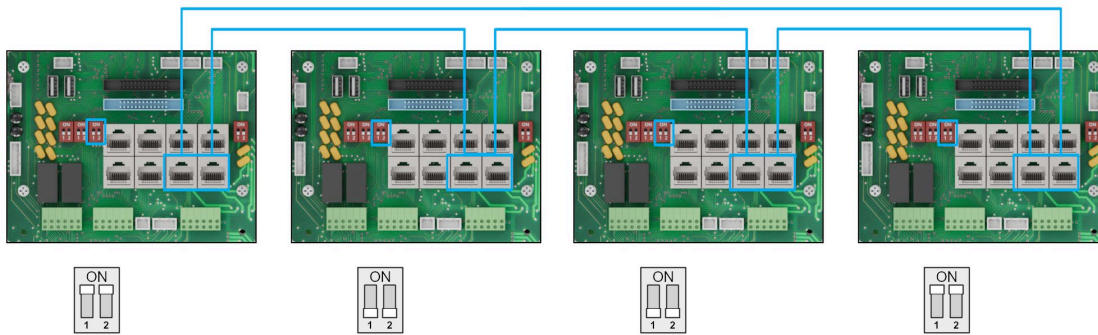

3. Ensure each inverter circuit breaker is in the open (OFF) position. No voltage should be coming in or out of the inverter at this point.
4. Using a multimeter, check the following:
 - a. Check the battery bank voltage is within operating range at the inverter DC breaker, or the external DC disconnect.
 - b. Check the PV voltage is within operating range at input connections of the DC isolation switch.
 - c. If utilizing AC input, double check each hot line to neutral connection supplying power to the inverter to ensure voltage is in operating range of the unit.
5. Upon confirming all voltages are within the inverter's operating range, set the inverter battery breaker to the closed (ON) position. If equipped, set the external battery breaker installed between the battery bank and inverter to the closed (ON) position.
6. Begin powering on each battery one at a time, starting with the master. Then power on each additional battery in ~5 second intervals.
7. Move the external PV isolator switch to the closed (ON) position (if equipped). Set the PV switch on the side of the inverter to the closed (ON) position.
8. If using AC input, set the external breaker between input panel and inverter to the closed (ON) position. Next, set the inverter GRID breaker to the closed (ON) position.
9. Check the front LED display to confirm unit powers on.
10. Configure the following settings using the EG4 Monitor Center or mobile app:
 - a. Common Tab
 - b. Application Tab
 - c. Discharge Tab
11. Power off all inverters. Then power on the master. Once the master inverter is powered up, power on each additional inverter.
12. After all the inverters are powered up, double check each inverter and verify the system type is set to "Parallel" and the battery shared option is selected.
13. Ensure the battery communications cable is properly connected from master battery to the master inverter.
14. Using the EG4 Monitor Center, mobile app, or LED indicators on the front of the unit, verify there are no faults or alarms.
15. Verify the loads panel is ready to accept current from the inverter. Set the input breaker at the loads panel to the closed (ON) position.
16. Set the output breaker on inverter to the closed (ON) position. The inverter should now be providing current to the loads panel.

7. REMOTE MONITORING CONFIGURATION

There are multiple ways for the inverter to be programmed and monitored. The most common and convenient are the EG4® Monitor Center Website (monitor.eg4electronics.com) and the EG4 Monitor App. The following sections discuss the various ways to communicate with the inverter.



Monitor Center Website



Monitor Center Overview



Monitor App for Android



Monitor App for Apple

7.1 DONGLE INSTALLATION

A Wi-Fi/4G dongle is used to monitor the inverter and remotely view the monitoring data on a computer or mobile device. Attach this module by plugging it in to the side of the inverter and securing it with the four (4) Phillips head screws.

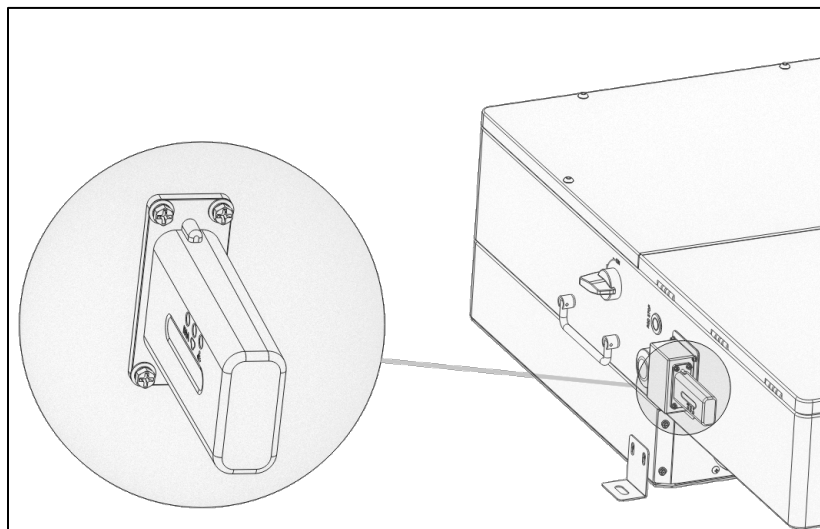

For Wi-Fi Dongle troubleshooting, scan the following QR code:



7.2 NEW USER ACCOUNT



NOTE:

The monitoring system may change due to updates. Therefore, UI descriptions may vary from the current pages on the site. If you have any questions, or to create distributor/installer accounts, contact support@eg4electronics.com for additional assistance.

USING EG4® MONITOR CENTER

1. Using a web browser, connect to “monitor.eg4electronics.com” and select on “Register”.
2. Complete the online form. Contact the distributor for the customer code. The dongle serial number (SN) and dongle PIN can be found on the sticker attached to the side of the dongle.
3. Once the registration is complete, return to the EG4 Monitor Center web page and login using the username and password created during the registration process.

Scan the code for additional information regarding the EG4 Monitor Center:

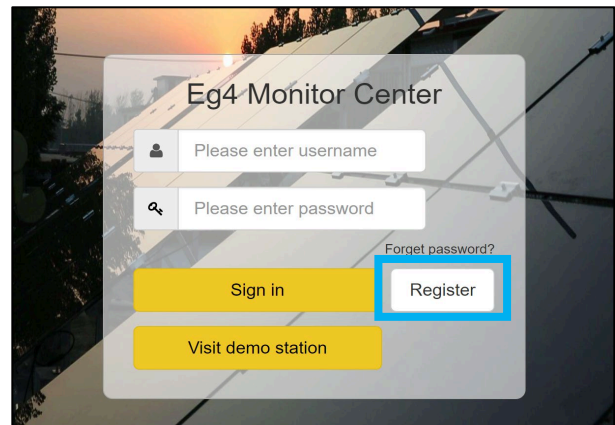

USING THE PHONE APP

1. Download the “EG4 Monitor” app for iOS or Android. After installation is complete, open the app.
2. Select “Register,” then complete the required information and press “Register”. Contact the distributor for the installer code.
3. Once the registration is complete, return to the login page and login using the username and password created during the registration process.

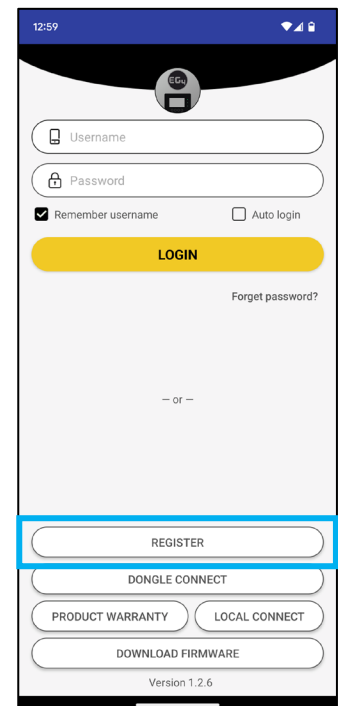

7.3 EXISTING USER ACCOUNT

When an EG4® account already exists, new EG4 hardware that utilizes a dongle can be added to the existing account. This can be completed using the Monitor Center or the phone app.

USING EG4 MONITOR CENTER:

1. Using a web browser, open “monitor.eg4electronics.com” and login with the existing username and password.
2. Navigate to the “Configuration” tab, then select “Dongles.”
3. Select “Add Dongle.”
4. Enter the new dongle serial number and pin, select the station to assign the dongle to, then click” Add.”
5. The EG4® FlexBOSS18 should now be available in Monitor Center.

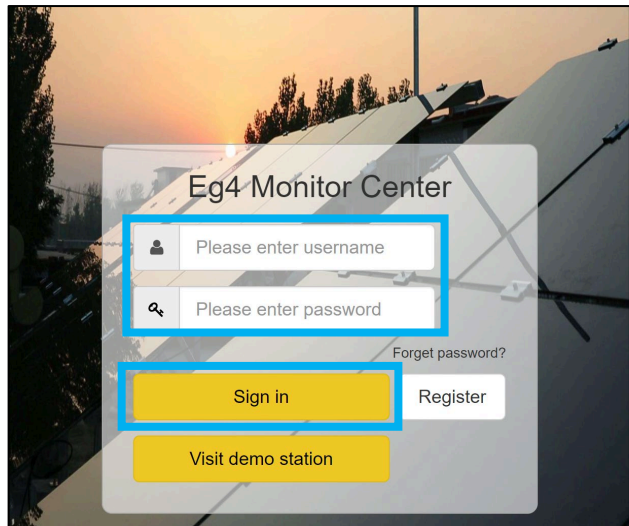

USING THE PHONE APP:

1. Open the “EG4 Monitor” app and login using an existing name and password.
2. Select the back arrow in the upper left corner of the screen.
3. Select “Add Dongle.” Scan or enter the dongle information located on the dongle sticker, then press “Add Dongle.”

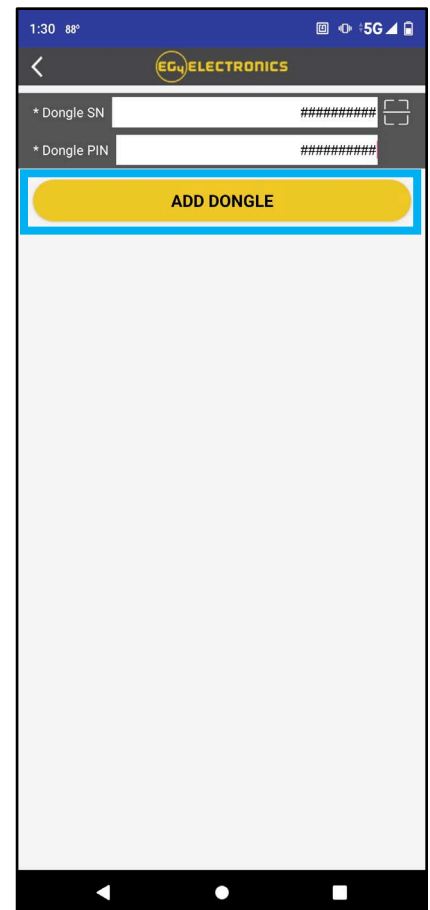
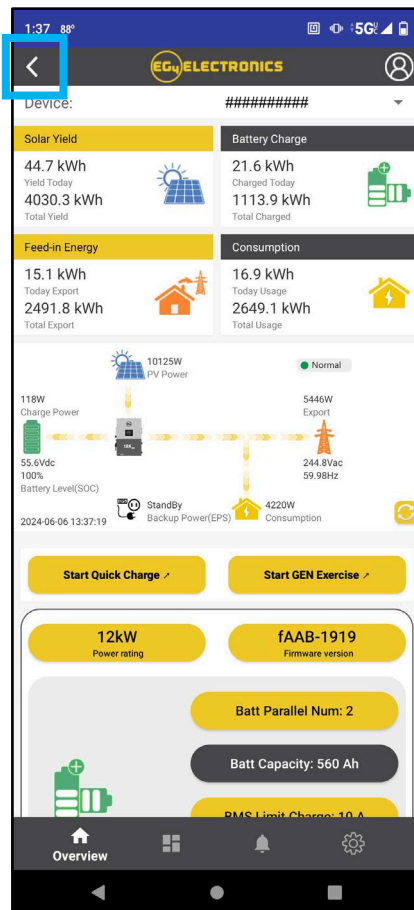
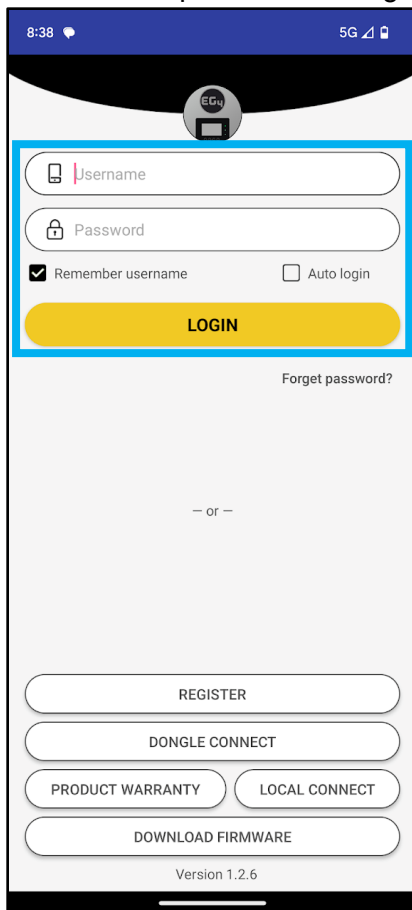

7.4 ENABLE APP NOTIFICATIONS

The EG4® Mobile App allows the end user to easily check real-time system information regarding the inverters, batteries, and other informative values.

ENABLE NOTIFICATIONS IN MONITOR CENTER:

1. Go to monitor.eg4electronics.com and login.

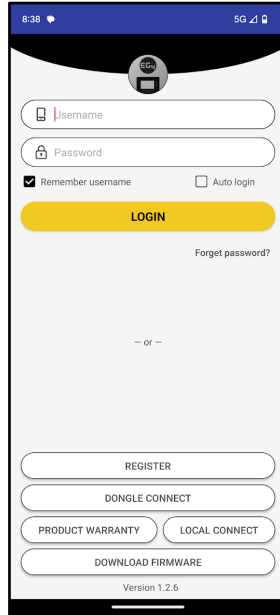

2. At the top of the screen, select "Configuration," then "Users."

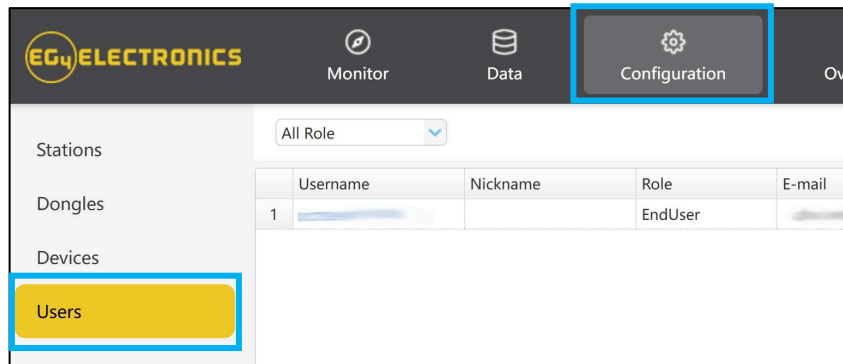

3. Select "User Management," then "APP Notice."

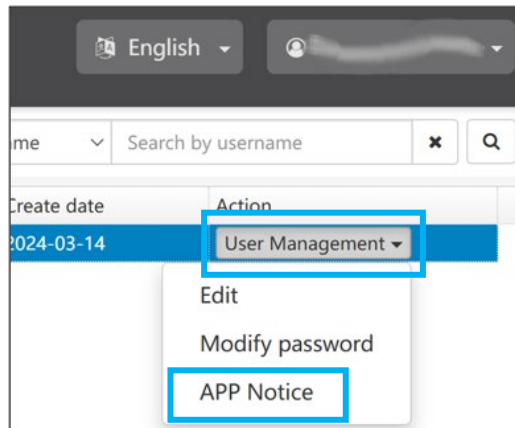

4. Choose which setting to enable, and what values will trigger a notification. Select “Edit.”

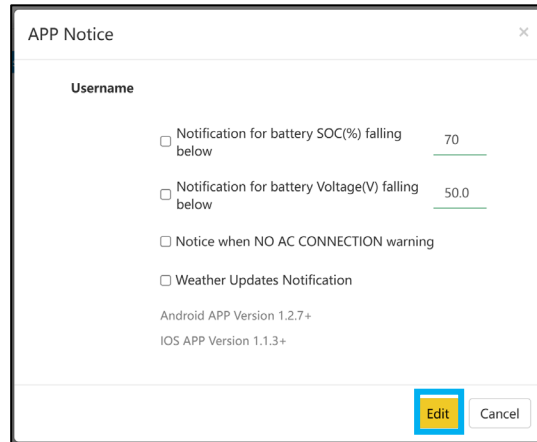

ENABLE NOTIFICATIONS ON A MOBILE DEVICE:

The EG4® Mobile App allows the end-user to easily check real-time system information regarding the inverters, batteries, and other informative values.



NOTE:

Ensure the app is up to date before proceeding!

1. Login to the EG4® Monitor App. Select the user icon at the top right corner of the screen.

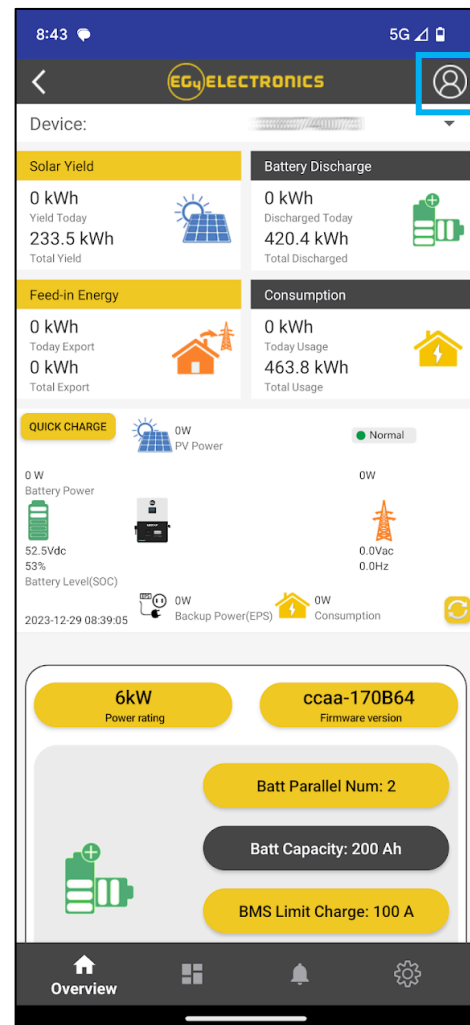
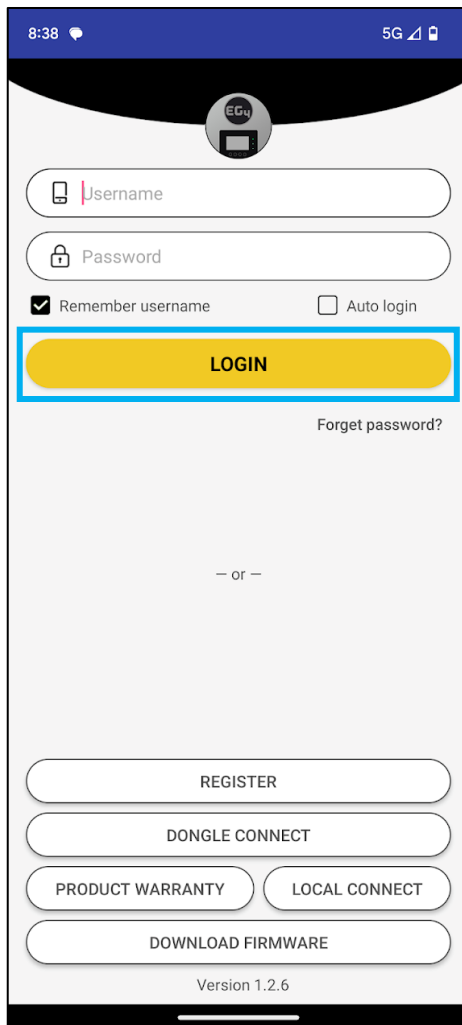

2. Select “Notifications,” “Allow Notifications,” and make selections for which notifications to receive. Toggle selection on to “Allow Notifications” on device and choose how to receive notifications

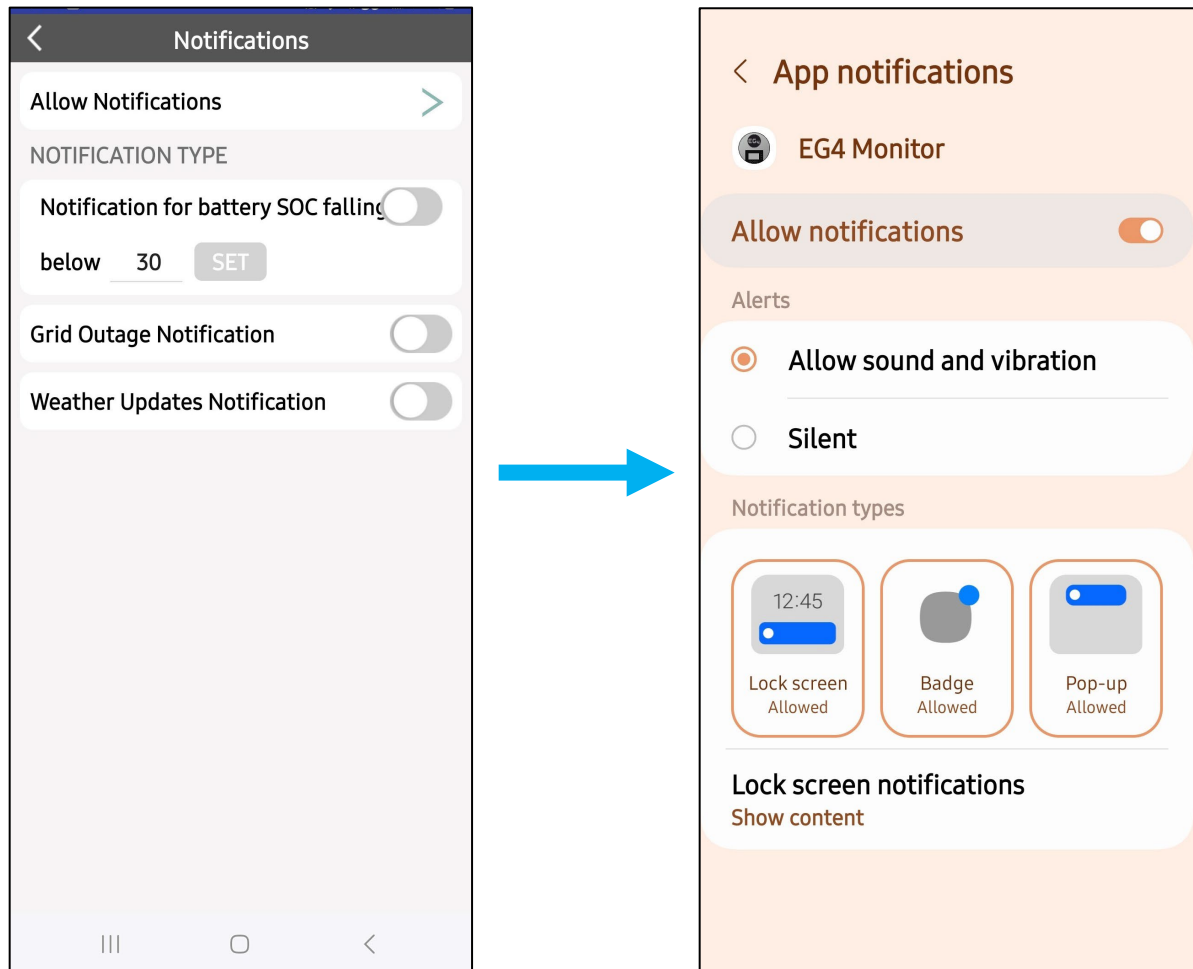

7.5 LOCAL MONITORING SETUP WITH THE EG4® MONITORING APP

If there is no Wi-Fi available at the location, use the local function to monitor or set up the system:

1. Download the EG4® Monitor app.
2. Connect the mobile device to the dongle's Wi-Fi hotspot after the INV LED on the Wi-Fi module is solid on. The name of the hotspot is the same as the serial number on the Wi-Fi module shell.
3. Select “Local Connect.” Now the system can be monitored and set up either through the hotspot connection or Bluetooth (on Android devices only).

8. MONITORING CENTER OVERVIEW

For the full list of EG4 Monitor Center settings and their functions, refer to the QR code below; the accompanying video provides additional guidance on using the Monitor Center.



EG4 Monitor
Center Overview



EG4 Monitor
Center Video

8.1 WORKING MODES AND WEATHER OPTIMIZATION SETTINGS



IMPORTANT:

These settings may need to be adjusted after installation. Consult with the distributors before making any changes to avoid conflicting settings or damage to the system!

TIME OF USE

Used to maximize cost savings by flexibly adjusting the battery's usage pattern, establishing a real-time connection with the grid, and providing live updates on current electricity prices. This enables the system to meet energy demands across different time periods, provide real-time system status, and provide detailed reports. This feature is customizable to individual needs and fluctuations in electricity prices.

WEATHER OPTIMIZE FUNCTION

The weather optimize function is used to collect real-time weather data and use that data to control the inverter. There are multiple operating modes to adapt to various scenarios:

- **Charge Priority Mode** prioritizes battery charging to ensure stable electricity usage, making it ideal for areas with unstable power supply.
- **Self-Use Mode** prioritizes self-generated solar power to meet household electricity demands, making it ideal for areas with high electricity prices.
- **Forced Charge/Discharge Mode** chooses to charge or discharge batteries based on electricity pricing, making it ideal for time-of-use pricing areas.
- **Intelligent Charging Control** automatically adjusts the state of charge to maximize the efficient use of solar energy based on real-time weather information.
- **Stable Electricity Usage** optimizes charging strategies based on weather conditions, ensuring the battery remains adequately charged for stable electricity consumption.

1. To enable this feature, select “Maintenance” at the top of the Monitor Center webpage.

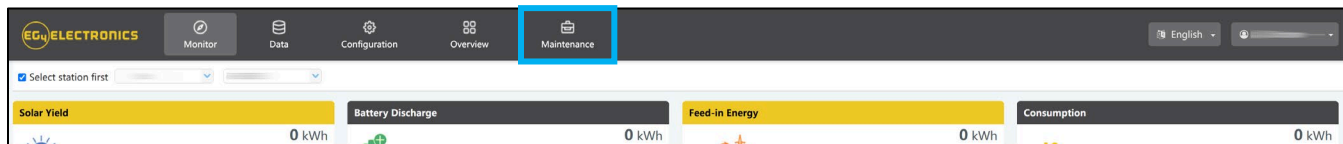

2. Select “Weather Optimization” to the left of the screen.

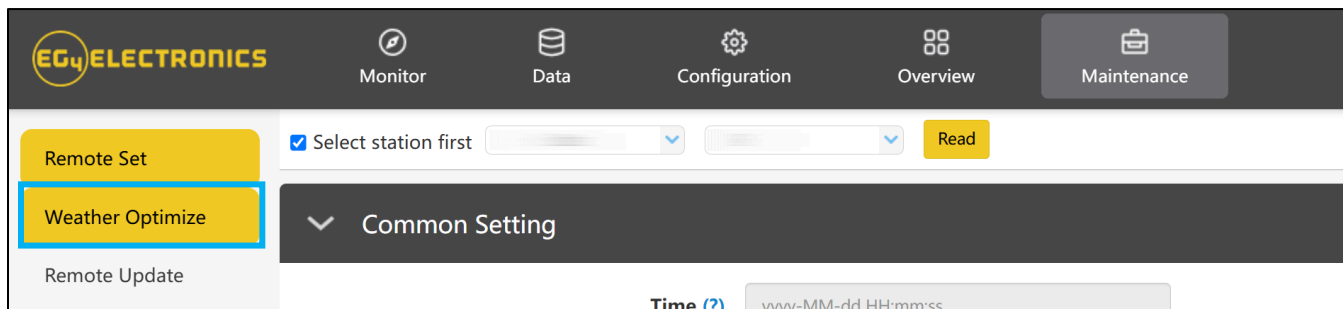

3. Select the desired inverter and click the location button.

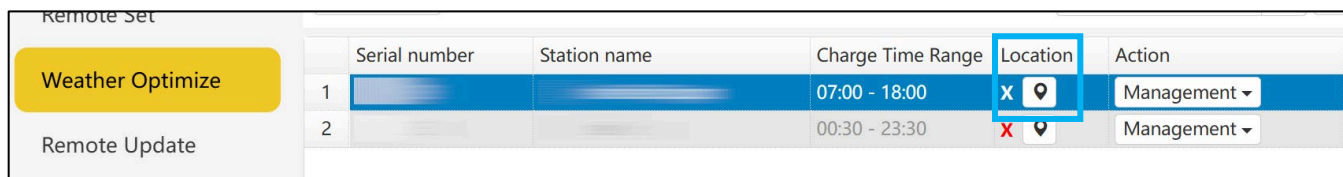

4. Input the inverter’s information on the next screen and select update.

A screenshot of the EG4 Monitor Center webpage showing a form for inputting inverter information. The form includes fields for 'Station name', 'LNG-LAT', 'Create time', 'Continent', 'Region', 'Country', and 'Timezone'. There are radio buttons for 'Daylight saving time' (Yes/No). The 'Update' button is highlighted with a blue box.

* Station name [input field] ✓

LNG-LAT [input field] [Location icon]

* Create time [input field] 2024-07-16

* Continent [input field] North America

* Region [input field] North America

* Country [input field] United States of America

* Timezone [input field] GMT -6

* Daylight saving time Yes No

[Update] [Export] [Cancel]

5. Afterwards, select “Management,” then “Edit.”

	Serial number	Station name	Charge Time Range	Location	Action
Weather Optimize	1		07:00 - 18:00	✓	Management
Remote Update	2		00:30 - 23:30	✗	Edit Disable

6. Set charging times and percentages based on electricity use patterns and weather conditions. The platform sends user settings to the inverter, and the inverter provides feedback, confirming the receipt of setting and executing charging operations according to user-defined parameters.

Edit
✕

*** Serial number**

*** Charge Start Time**

*** Charge End Time**

Charge percent(%) by weather:

*** Clear sky**

*** Few(11%-25%) clouds**

*** Scattered(25%-50%) clouds**

*** Broken(51%-84%) clouds**

*** Overcast(85%-100%) clouds**

*** Light rain**

*** Moderate rain**

*** Heavy rain**

*** Other**

WORKING MODES

Working modes are pre-set priority systems that allow users to configure the system to meet their demands through extensive customizations. These modes can be found under the Maintenance tab by clicking “Working Mode.” Scroll past “Application Setting” to the “Working Mode Setting” section.

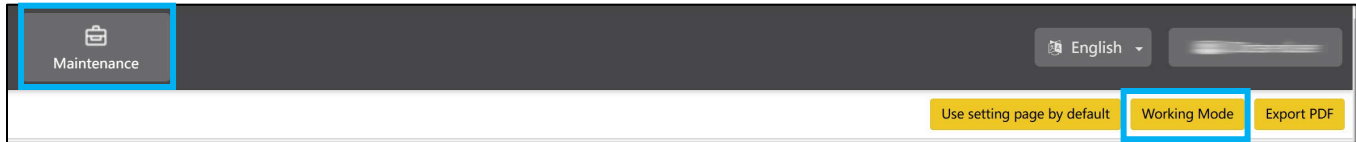

WORKING MODE DEFINITIONS:

- **Backup Mode:** Battery power used as a last resort. The solar array powers the loads, and when PV is insufficient, loads will pull from the grid. The inverter will only power loads with battery when PV and AC input is unavailable.
- **Peak Shaving:** Used to avoid peak demand charges from the grid by using a combination of settings to limit the power drawn from the grid.
- **AC Charge Mode:** Used to charge batteries with grid power when electricity prices are cheap, and discharge battery power to supply load or export to the grid when electricity prices are high.
- **PV Charge Priority:** Used to charge battery bank with PV; once battery bank is charged, then PV will be used to power loads.
- **Forced Discharge/Export PV Only:** Used to sell PV and/or battery power back to the grid.
- **Self-Consumption:** Used to significantly lower grid consumption. Solar arrays power loads and, when PV is insufficient, batteries power loads; AC is only used as a last resort.

BACKUP MODE

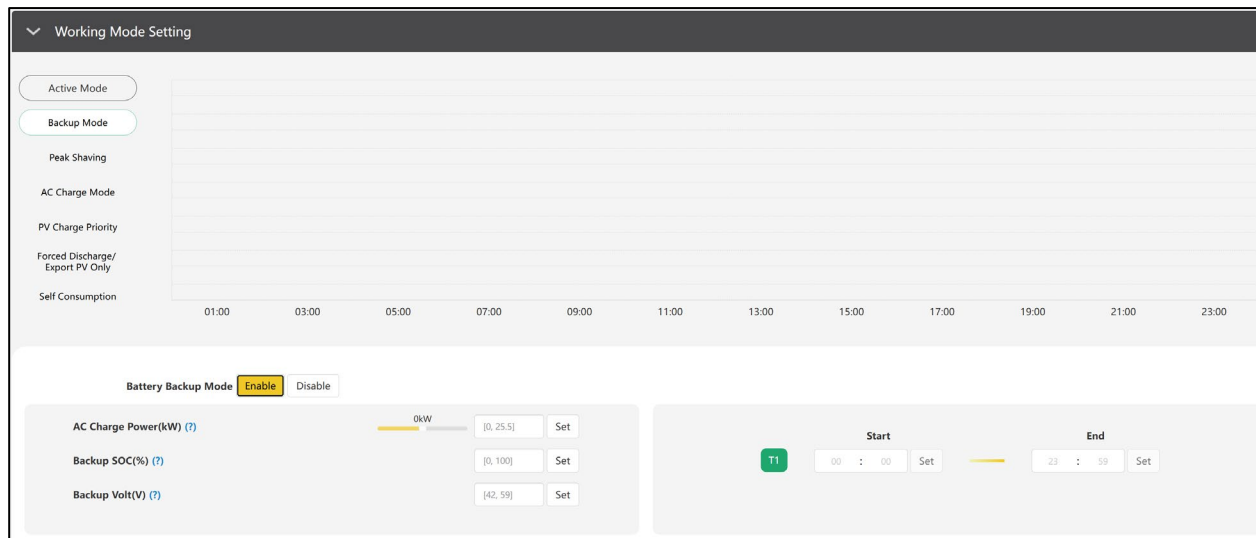

- **Battery Backup Mode:** When enabled, the system will use the batteries as a last resort during the set timeframes.
- **AC Charge Power (kW):** The maximum charging power from grid.
- **Backup SOC(%):** Set the maximum SOC for backup. This parameter is the same as Stop AC Charge SOC.
- **Backup Volt(V):** Set the maximum Voltage for backup. This parameter is the same as Stop AC Charge Volt.
- **Start/End Times:** Set times to begin and end Backup Mode.

PEAK SHAVING

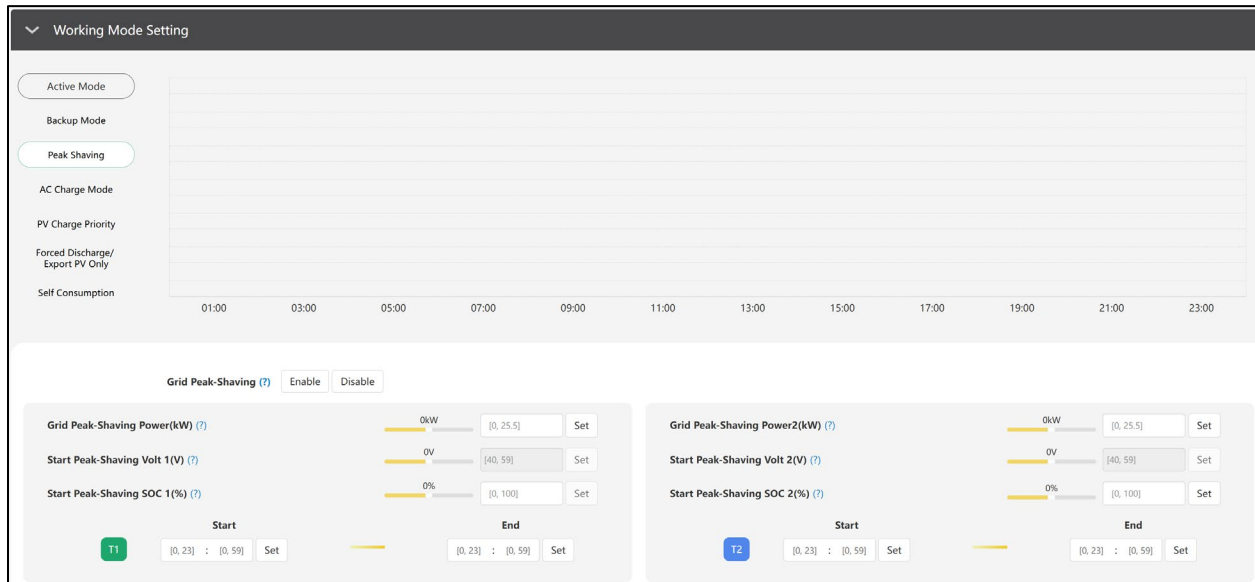

Grid Peak-Shaving: Enable grid peak-shaving.

- **Grid Peak-Shaving Power(kW)/Grid Peak-Shaving Power2(kW):** Set the maximum amount of power that will be drawn from the grid.
- **Start Peak-Shaving Volt 1(V)/Start Peak-Shaving Volt 2(V):** Set the starting point of peak-shaving when using voltage setpoints for batteries.
- **Start Peak-Shaving SOC 1(%) / Start Peak-Shaving SOC 2(%):** Set the starting point of peak-shaving when using SOC setpoints for batteries.
- **T1/T2 Start/End:** Set the start/end time of peak-shaving depending on SOC/voltage as configured above.

AC CHARGE MODE

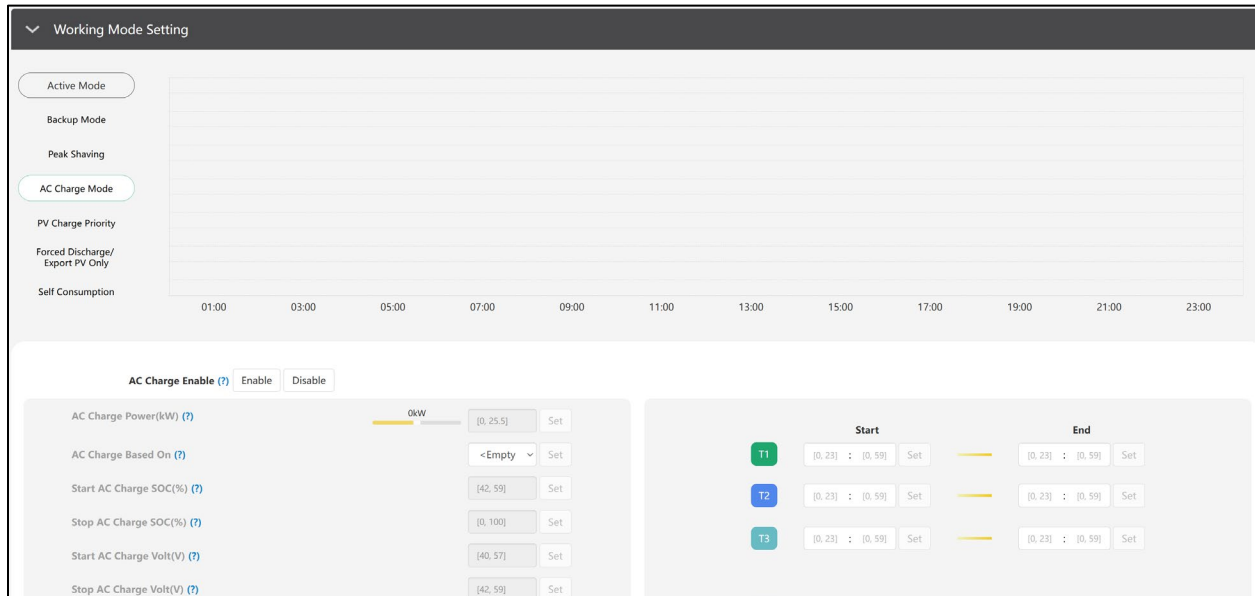

AC Charge Enable: Enable the system's ability to charge batteries from the grid.

- **AC Charge Power(kW):** Set the maximum power drawn from the grid to charge batteries.
- **AC Charge Based On (SOC/Volt/Time):** Configure how the system will charge batteries from the grid by setting custom voltage points, SOC of batteries, or by time.

- **Start/Stop AC Charge SOC(%):** Set the starting point of AC Charging when using SOC setpoints for batteries.
- **Start/Stop AC Charge Volt(V):** Set the starting point of AC Charging when using voltage setpoints for batteries.
- **T1/T2/T3 Start/End:** Set the start/end time of AC Charge mode depending on SOC/voltage as configured above.

PV CHARGE PRIORITY

The order of priority for solar power usage will be Battery >Load >Grid. During the “PV Charge Priority” period, loads are first supplied power from the grid. If there is excess solar power after charging batteries, the excess solar will power the loads along with grid power.

- **PV Charge Priority:** Enable the Battery Priority/PV Charge Priority working mode.
- **PV Charge Power(kW):** Set the maximum amount of power to charge the batteries from solar.
- **PV Charge Priority Stop SOC(%)/Volt:** Set the stop point for PV Charge Priority according to SOC or Voltage.
- **T1/T2/T3 Start/End:** Set up to three different start and stop times for the PV Charge Priority working mode.

FORCED DISCHARGE/EXPORT PV ONLY

- **Forced Discharge Enable:** Enable this setting to forcefully discharge the station’s battery bank.

- **Export PV Only:** Enable this setting to sell back generated PV power to the grid.
- **Forced Discharge Power(kW):** Set the maximum power limit of battery discharge.
- **Stop Discharge SOC(%)/Volt:** Stop the forced discharge upon reaching the set SOC/voltage point.
- **T1/T2/T3 Start/End:** Set up to three different start and stop times for the Force Discharge/Export PV Only working mode.

SELF CONSUMPTION

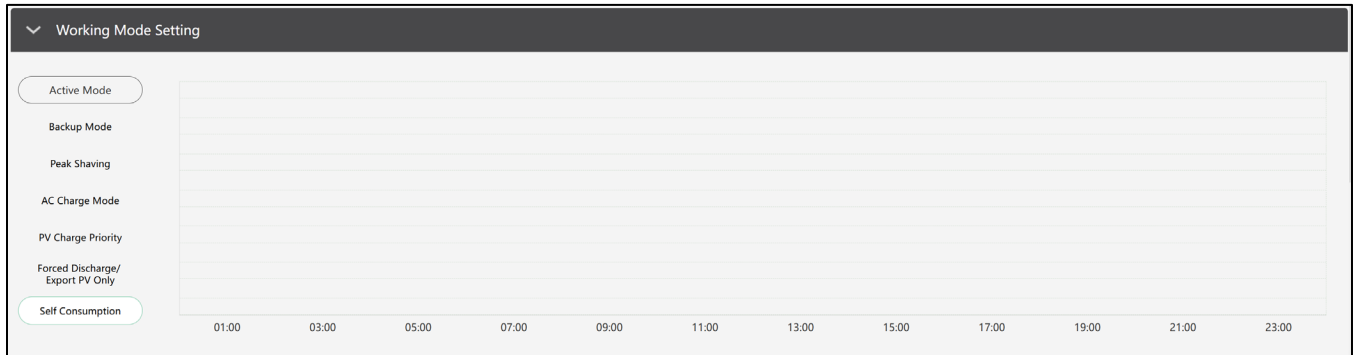

The system will default to Self-Consumption mode. The order of priority for powering loads is Solar > Battery > Grid. The order priority for solar power is Load > Battery > Grid which creates an ideal scenario when needing to prioritize solar power generation over other types of power. Self-Consumption mode will increase the self-consumption rate of solar power and reduce energy bills significantly. Effective when Charge Priority, AC Charge, and Forced Discharge are disabled.

9. POWER CONTROL SYSTEM

9.1 EXPORT LIMITING FROM ALL SOURCES (PEL)

- A. **Export to Grid:** Enables power export to the grid.
- B. **Max export to Grid (kW):** Sets the maximum allowable power export to the grid setting.
 - a. **Note:** To allow power export from the inverter to the grid, "Export to Grid" must be enabled, and "Max Export to Grid" must be set to a value greater than 0. This value defines the upper limit of export power.
- C. **Zero Export:** Disables all power export to the grid.

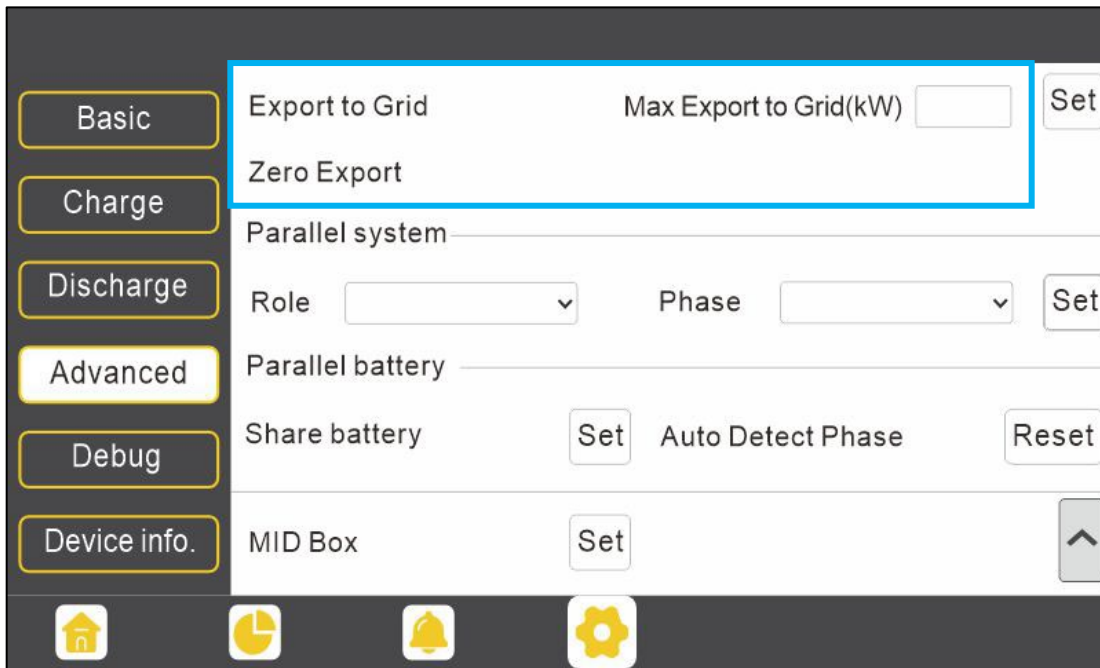

- D. **Discharge current limit (A):** Defines the maximum discharge current allowed from the battery.

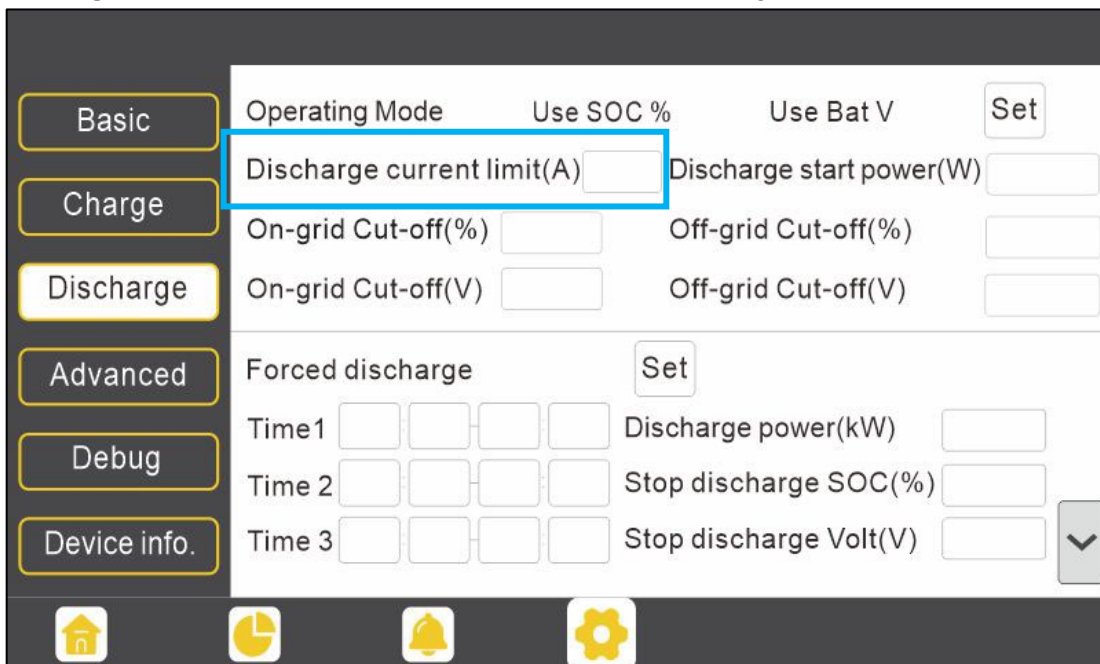

- E. **Discharge power (kW):** Sets the maximum power the battery can deliver when the *Forced Discharge* function is enabled.

The screenshot shows the control interface with the following settings visible:

- Basic:** Operating Mode, Use SOC %, Use Bat V, Set
- Charge:** Discharge current limit(A) [input], Discharge start power(W) [input]
- Discharge:** On-grid Cut-off(%) [input], Off-grid Cut-off(%) [input], On-grid Cut-off(V) [input], Off-grid Cut-off(V) [input]
- Advanced:** Forced discharge [Set], Discharge power(kW) [input] (highlighted), Stop discharge SOC(%) [input]
- Debug:** Time 1 [input], Time 2 [input], Time 3 [input], Stop discharge Volt(V) [input]
- Device info.** [input]

PREREQUISITE: EXPORT TO GRID IS ENABLED.

For example: Max Export to Grid is 5kW.

- If the system has battery power but there is no PV coming in (perhaps because the sun is down, or because it does not have PV established in the system). To export power to the grid, the *Forced Discharge* function must be enabled.
 - If Discharge Power is set to 4kW, and the Discharge Current Limit is set to 200A, with a nominal battery voltage of 50V ($200A * 50V = 10,000W$, indicating the power that the battery can output), then the system will export 4kW to the grid.
 - If the Discharge Current Limit is reduced to 50A (With the other settings unchanged from the previous example), the system will export only 2.5kW ($50A * 50V$).
- If the system has PV and battery, but *Forced Discharge* is disabled:
 - Only excess PV power is exported to the grid. The battery does not discharge to the grid.
- If the system has PV and battery, and *Force Discharge* is enabled:
 - Both PV and battery output their available power to the grid, up to the set limits.

9.2 ESS MODE

- **Unrestricted Mode:** The ESS may import active power from the Area EPS while charging and may export active power to the Area EPS while discharging.
- **Export Only Mode:** The ESS may export active power to the Area EPS during discharging but shall not import active power from the Area EPS for ESS charging purposes.
- **Import Only Mode:** The ESS may import active power from the Area EPS for charging purposes but shall not export active power from the ESS to the Area EPS.
- **No Exchange Mode:** The ESS shall not exchange active power with the Area EPS for charging or discharging purposes.



NOTE: *This mode is alternatively known as “No Export Mode”.*

Mode	Maximum Current (Charging)	Maximum Current (Discharging)	Overcurrent Protection (Charging)	Overcurrent Protection (Discharging)
Unrestricted Mode	48.08A/208V 41.67A/240V	54.17A	60.096A (125%)	67.708A (125%)
Export Only Mode	0A	54.17A	N/A	67.708A (125%)
Import Only Mode	48.08A/208V 41.67A/240V	0A	60.096A (125%)	N/A
No Exchange Mode	0A	0A	N/A	N/A

SCHEMATIC DIAGRAM

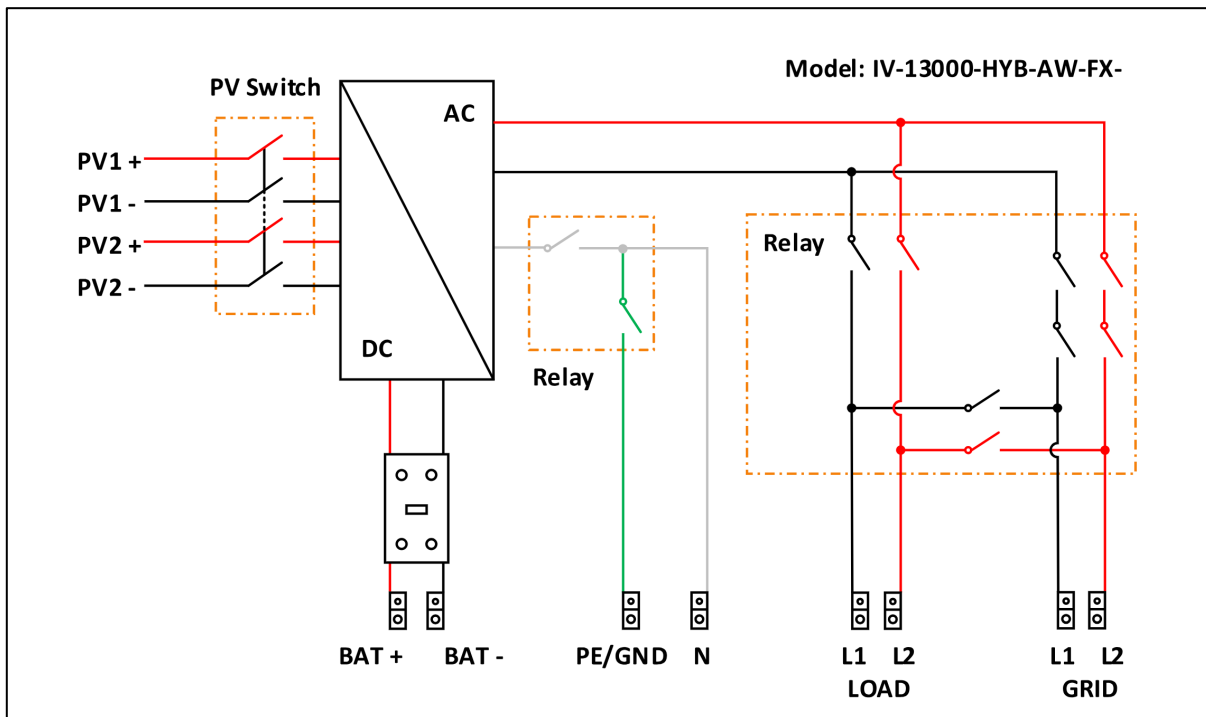

MODE DESCRIPTIONS

Item	Mode	Time
1	Step Change in Load Test	The average open loop response time: 0.37s The maximum open loop response time:0.85s
2	Step Change in Generation Test	The average open loop response time:0.12s The maximum open loop response time:0.35s
3	Export limiting from all sources	The average open loop response time:1.92s The maximum open loop response time:2.00s
4	Import limiting from all sources	The average open loop response time:1.11s The maximum open loop response time:1.95s
5	ESS Operating Modes Unrestricted Mode	The average open loop response time:0.37s The maximum open loop response time:0.85s
6	ESS Operating Modes Export Only Mode	The average open loop response time:0.22s The maximum open loop response time:0.70s
7	ESS Operating Modes Import Only Mode	The average open loop response time:0.43s The maximum open loop response time:0.95s
8	ESS Operating Modes No Exchange Mode	The average open loop response time:0.12s The maximum open loop response time:0.35s
9	Export limiting from Energy Storage Systems	The average open loop response time:0.22s The maximum open loop response time:0.70s
10	Import limiting to Energy Storage Systems	The average open loop response time:0.43s The maximum open loop response time:0.95s

10. RAPID SHUTDOWN/ESS DISCONNECT

10.1 OVERVIEW

The inverter includes a rapid shutdown system with built-in RSD transmitter and RSD/ESS disconnect initiator. In case of emergency, press the rapid shutdown button to cut off the power supply, cutting the inverter's AC output along with dropping the PV conductor's voltage to <30V in 30 seconds.



NOTE:

When using supported EG4® batteries in closed-loop communications with the inverter, the RSD also initiates ESS disconnect as required by NEC code.



10.2 EXTERNAL RSD/ESS DISCONNECT

The system can utilize an External E-Stop Switch if the local AHJ deems it necessary.

- The external switch must be “Normally Closed” by default, and “Open” when the button is pressed for emergency shutdown.
- The external switch should be connected to the RSD terminals on the inverter and mounted on a readily accessible location outdoors (check with the local AHJ for requirements).
- Remove jumper from external RSD connection and wire the E-Stop Switch into the RSD terminals according to the switch's specifications.

EXTERNAL RSD WIRING

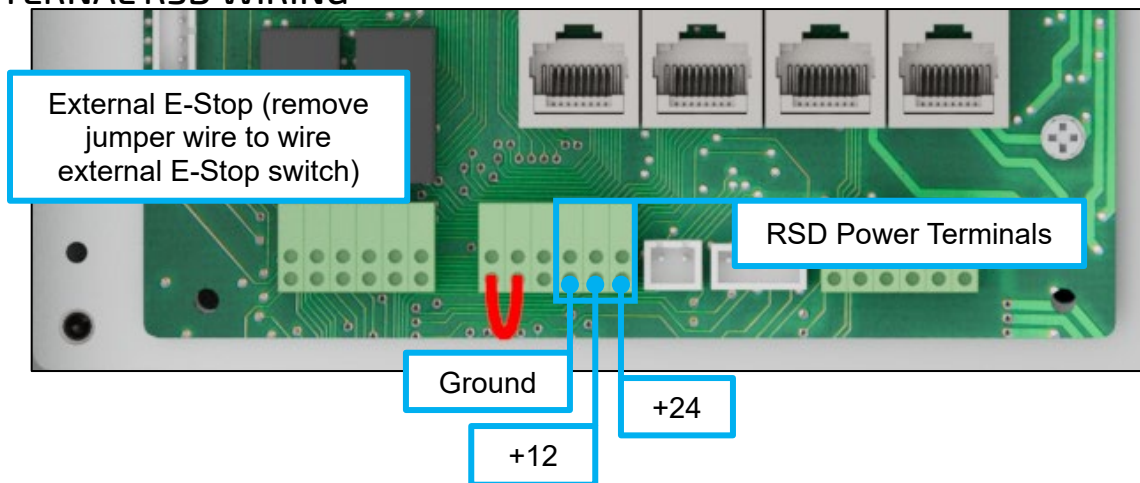

11. WORKING WITH A GRIDBOSS

While the FlexBOSS18 is a hybrid inverter that is capable of functioning on its own, pairing it with the EG4® GridBOSS allows for more flexibility and functionality.

FUNCTION	DESCRIPTION
AC Coupling	Allows the user to pair the FlexBOSS18 and Grid BOSS with existing or new grid-tie only inverters.
Smart Loads	Smart loads control devices that are powered on or off according to grid presence, state of charge, TOU, and/or the presence and level of PV power.
Generator Functions	Allows the user the option of a backup generator for when the grid is down, and PV is insufficient to power loads.



CAUTION:

When pairing with GridBOSS, ensure the FlexBOSS18's firmware is updated to at least version 1E1E or the units will not operate as intended!

When installing both GridBOSS and FlexBOSS18 together:

- Check that the firmware is up to date, with the minimum firmware being 1E1E.
Note: Once the firmware has been updated, it cannot be undone.
- Ensure the mounting wall is strong enough to bear the weight of all units.
- Maintain at least 150 mm of spacing on each side between units.
- Observe all environmental specifications for all units.
- The Loads port will not be used on the FlexBOSS18.
- The CT clamps provided with the inverter will not be used as all input/output data will be tracked by GridBOSS.
- Ensure that all parallel inverters are configured before configuring GridBOSS.

For more information on GridBOSS and specific use cases, scan the following QR code:



12. INVERTER MAINTENANCE

Electrical equipment must be properly maintained to increase longevity and consistency. Follow the steps below to help prevent component damage/deterioration:

1. Inspect the inverter every month to confirm nothing covers the inverter's vents. If it is covered, shut down the inverter and clear the vents to restore proper cooling.
2. Inspect the inverter every 3 months to verify the operating parameters are normal, and there is no abnormal heating or noise from any components in the system.
3. Inspect the inverter every 6 months to check for any damaged cables, accessories, or terminals.

If unable to identify the source of any abnormal operations, contact the distributor's technical support team for additional information.

12.1 START-UP & SHUTDOWN PROCEDURES

STARTING UP THE INVERTER

1. If using an external DC breaker between the battery bank and the inverter, turn it on. If not, turn on the BAT breaker located in the cable box of the inverter and then power on the battery system one battery at a time.
2. Make sure the PV voltages of the strings are within operating parameters (120 – 440 VDC). Turn on the PV isolator switches between the inverter and array and then turn on the PV Disconnect switch on the side of the inverter.
3. Make sure Steps 1 and 2 are running properly and then turn on the grid power breaker.
4. Ensure there the inverter shows "normal" operations in the monitoring center and the LEDs on the front of the unit.
5. Power on the load breakers in the load panel.



DANGER:

Avoid shutting down the inverter while under heavy loads. To minimize stress on the inverter, shut down in the following sequence. In case of emergency, use the RSD.

SHUTTING DOWN THE INVERTER

1. Set the inverter into Standby mode using either the mobile app or EG4® Monitor Center.
2. Switch off the load breaker.
3. Turn off the grid breaker feeding the inverter.
4. Turn off the PV disconnect and then the battery breaker. Wait for the LEDs on the front of the unit to go off.

12.2 FIRMWARE UPDATES VIA THE EG4® ELECTRONICS APP

Before updating firmware through the EG4® Monitor app, ensure the mobile device being used has enough battery life to last through the update. While the update is ongoing, do not close the application. Ensure the Wi-Fi dongle is securely connected and correctly configured (see section 7.1 for details) before performing the following steps:

1. Open the EG4 Electronics app on a mobile device and select the “DOWNLOAD FIRMWARE” button.
2. Choose the correct firmware file (see eg4electronics.com for the most up-to-date files) and select “DOWNLOAD” on the right side to download the file to the mobile device.
3. Keep the app running and go to the mobile device’s Wi-Fi settings. Connect the mobile device to the dongle’s Wi-Fi network. The dongle’s network ID will be the same as the dongle’s serial number.
4. Return to the home screen of the app and select “LOCAL CONNECT.” Select the “Set” button on the bottom right side and proceed to the next step.
5. After completing step 4, the Local Set Interface will appear. Swipe to the bottom of the screen and select “UPDATE FIRMWARE.”
6. Choose the correct installation package in the dropdown box and select “UPDATE FIRMWARE” to begin the updating process.

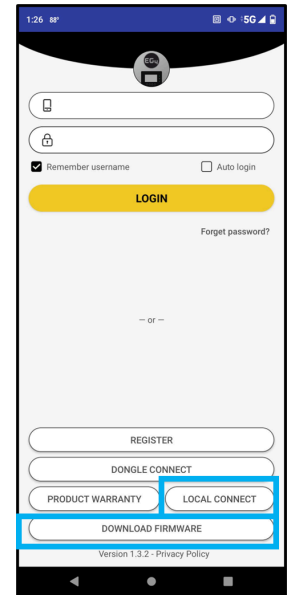

After selecting the “UPDATE FIRMWARE” button, the update will begin. Update progress can be viewed via the app. Once the update is completed, a notification will appear confirming that the firmware has been successfully updated. After successfully updating firmware, the inverter will restart itself. Make sure to update all inverters installed in the same Energy Storage System (ESS) to the latest firmware version.

12.3 FIRMWARE UPDATE VIA MONITORING CENTER (WEBSITE)

1. Users can update firmware by using the EG4® Electronics website monitoring system. Contact EG4® to make sure the files are correct.
2. Log in to the EG4® Electronics Monitor System. Select “Maintenance,” and then select “Remote Update.”
3. Choose the inverter to update and then select “Standard Update.” The Monitor Center will begin updating both firmware files in the inverter. The latest version of the firmware will be displayed in the bottom right window.







IMPORTANT:

Throughout the update, the inverter will automatically cycle power as it moves from one update to the next; however, if at any time an “Update Failed” alert appears, restart the full update from the first task. The “Update Failed” alert will only appear in the monitoring center. The software may need more than one attempt to update. If unable to successfully update the firmware, contact the distributor.

13. INVERTER TROUBLESHOOTING

If a warning or fault occurs, users can troubleshoot according to the LED status description and the warning/fault information found in the “Event History” tab on the app or Monitor Center website.

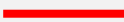
LED	DISPLAY	DESCRIPTION	ACTION
Green LED	Solid on 	Working normally	No action needed
	Flashing every 1 sec 	Standby	No action needed
	Flashing every 0.1 sec 	Firmware updating	Wait until the update is complete
Yellow LED	Solid on 	Warning, inverter may stop working	Needs troubleshooting
Red LED	Solid on 	Fault, inverter will stop working	Needs troubleshooting

Website

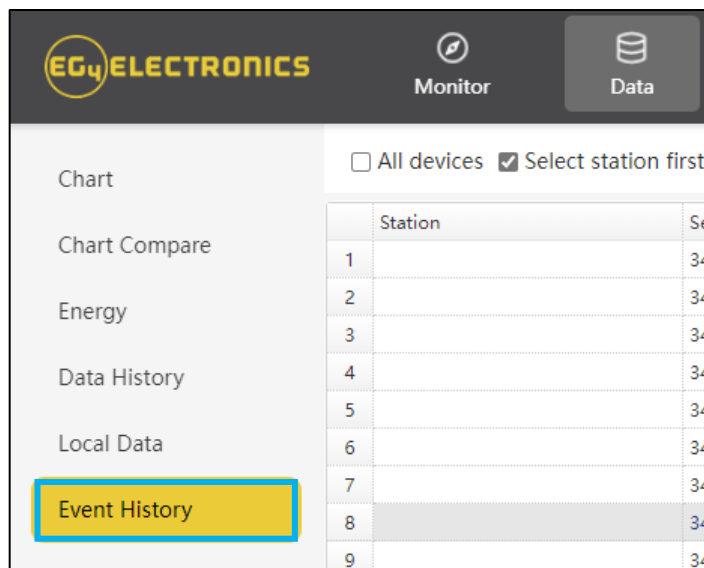

Mobile App



13.1 FAULT DEFINITIONS & TROUBLESHOOTING

FAULT	MEANING	TROUBLESHOOTING
M3 Rx failure	M3 microprocessor fails to receive data from DSP	Restart the inverter. If the error persists, contact the distributor.
Model fault	Incorrect model value	
EPS short circuit	Inverter detected short-circuit on load output terminals	<ol style="list-style-type: none"> 1. Check if the L1, L2, and N wires are connected correctly at the inverter load output terminal. 2. Restart the inverter. If the fault persists, contact the distributor.
EPS power reserved	Inverter detected short circuit on load terminal	Restart the inverter. If the fault persists, contact the distributor.
Bus short circuit	DC Bus is short circuited.	
Relay fault	Relay abnormal	
M8 Tx failure	DSP fails to receive data from M8 microprocessor	
M3 Tx failure	DPS fails to receive data from M3 microprocessor	
Vbus over range	DC Bus voltage too high	Ensure the PV string voltage is within the inverter specification. If string voltage is within range and this fault persists, contact the distributor.
EPS connect fault	Load terminal and grid terminal are wired incorrectly or reversed	Check if the wires on load terminal and grid terminal are wired correctly. If the fault persists, contact the distributor.
PV volt high	PV voltage is too high	Check if the PV string voltage is within the inverter specification. If string voltage is within range and this fault persists, contact the distributor.
Hard over curr	Hardware level over current protection triggered.	Restart the inverter. If the fault persists, contact the distributor.
Neutral fault	Voltage between N and G is greater than 30V	Ensure the neutral wire is connected correctly.
PV short circuit	Short circuit detected on PV input	Disconnect all PV strings from the inverter. If the error persists, contact the distributor.
Temperature fault	Heat sink temperature too high	Install the inverter in a place with good ventilation and no direct sunlight. If the installation site is okay, check if the NTC connector inside the inverter is loose.
Bus sample fault	Inverter detected DC bus voltage lower than PV input voltage	Restart the inverter, if the fault persists, contact the distributor.
Inconsistent	Sampled grid voltage values of DSP and M8 microprocessors are inconsistent	
M8 Rx fault	M8 microprocessor fails to receive data from DSP	
Para Comm error	Parallel communication abnormal	<ol style="list-style-type: none"> 1. Check whether the connection of the parallel cable is loose. Connect the parallel cable correctly. 2. Ensure the PIC status of the CAN communication cable from the first to the end inverter is connected correctly.
Para master loss	No master in the parallel system	<ol style="list-style-type: none"> 1. If a master has been configured in the system, the fault will automatically be removed after the master works.

		2. If a master has not been configured and there are only slaves in the system, set the master first. Note: For a single-unit system, the role of the inverter should be set as "1 Phase Master."
Para rating Diff	Rated power of parallel inverter(s) are inconsistent	Confirm that the rated power of all inverters is the same.
Para Phase set error	Incorrect setting of phase in parallel	Confirm the wiring for the parallel system is correct. Once verified, connect each inverter to the grid. The system will automatically detect the phase sequence, and the fault automatically resolves after the phase sequence is detected. If the fault persists, contact the distributor.
Para sync loss	Parallel inverter fault	Restart the inverter. If the fault persists, contact the distributor.

13.2 ALARM DEFINITIONS & TROUBLESHOOTING

ALARM	MEANING	TROUBLESHOOTING
Bat com failure	Inverter fails to communicate with battery	Check if the communication cable pinout is correct, and if the correct battery brand has been chosen. If all is correct but this alarm persists, contact the distributor.
AFCI com failure	Inverter fails to communicate with AFCI module	Restart the inverter. If the error persists, contact the distributor.
AFCI high	PV arc fault is detected	Check each PV string for correct open circuit voltage and short-circuit current. If the PV strings are in good condition, clear the alarm.
Meter com failure	Inverter fails to communicate with the meter	Check if the communication cable is connected correctly and in good working condition. Restart the inverter. If the alarm persists, contact the distributor.
Bat fault	Battery cannot charge or discharge	<ol style="list-style-type: none"> 1. Check the battery communication cable for correct pinout on both inverter and battery end. 2. Check if an incorrect battery brand has been chosen. 3. Check if there is a fault on the battery's indicator. If there is a fault, contact the battery distributor.
Fwn mismatch	Firmware version mismatch between the microprocessors	Attempt the firmware update again following the steps in section 12.2; if the fault persists, contact distributor.
Fan stuck	Cooling fan(s) are stuck	Contact distributor.
Trip by GFCI high	Inverter detected leakage current on AC side	<ol style="list-style-type: none"> 1. Check if there is ground fault on the grid and load side. 2. Restart the inverter. If the alarm persists, contact the distributor.
Trip by DCI high	Inverter detected high DC injection current on grid terminal	Restart the inverter. If the alarm persists, contact the distributor.

PV short circuit	Inverter detected a short circuit in PV input	1. Check whether each PV string is connected correctly. 2. Restart the inverter. If the alarm persists, contact the distributor.
GFCI module fault	GFCI module is abnormal	Restart the inverter. If the alarm persists, contact the distributor.
Bat volt high	Battery voltage too high	Check whether the battery voltage exceeds 59.9V; battery voltage should be within inverter specification.
Bat volt low	Battery voltage too low	Check whether the battery voltage is under 40V; battery voltage should be within inverter specification.
Bat open	Battery is disconnected from inverter	Check the battery breaker or fuse. Reconnect as needed.
Off-grid overload	Overload on load terminal	Check if load power on inverter LOAD terminal is within inverter specification.
Off-grid overvolt	Load voltage is too high	Verify that all loads are operating at 120V L-N or 240V L1-L2. If the alarm persists, contact distributor.
Meter reversed	Meter connection is reversed	Check if the meter communication cable is connected correctly on the inverter and meter sides.
Off-grid VDC high	High DC voltage component on load output when running off-grid	Verify that all strings are operating within PV voltage range. Restart the inverter. If the alarm persists, contact the distributor.
RSD Active	Rapid shutdown activated	Check if the RSD switch is pressed.
Para phase loss	Phase losing in parallel system	Confirm that the wiring of the inverter is correct. If the master is set to 3-phase master, the number of parallel inverters must be ≥ 3 . (The grid input for each inverter should be connected correctly to grid L1, L2, L3.) If the master is set to 2x 208 master, the number of parallel inverters needs to be ≥ 2 . (And the grid input of each inverter should be connected correctly to grid L1, L2, L3.)
Para no BM set	Master is not set in the parallel system	Set one of the inverters in the parallel system as the master.
Para multi-BM set	Multiple Primaries have been set in the parallel system	There are at least two inverters set as the master in the parallel system. Keep one master and set the other as slave.

14. DONGLE TROUBLESHOOTING

14.1 LEDS & BUTTON FUNCTIONALITY

- **LEDs:** Each of the three LEDs on the dongle will illuminate green when the boot/configuration process is complete.
- **Bottom Button:** When using dongle firmware version 2.0 or later, press the button on the bottom of the dongle to perform the following:
- **Reboot the dongle:** Hold down the button for 5 seconds, then release.
- **Disable encryption:** Hold down the button for 10 seconds, then release.



NOTE:

It is recommended to use a small Phillips screwdriver or similar object to press the button to ensure it is being pressed in far enough to make the change. The dongle will not reboot until the button is pressed and held for 5 seconds.

14.2 DONGLE BOOTUP STEPS

The following steps describe the Wi-Fi dongle bootup sequence:

1. After the Wi-Fi Dongle receives power from the inverter and completes the first step in the bootup process, the Wi-Fi LED should be on. The dongle then creates a hotspot for supported devices to connect to.
2. Once the dongle is properly configured, it should successfully connect to the home Wi-Fi network and then to the internet. The Cloud LED will illuminate once the dongle connects to the monitoring server via the internet.
3. Once the dongle has a connection to the monitoring server, it will then set up an internal connection to the inverter. When internal communication is successful, the INV LED is solid on.
4. When all three dongle LEDs are on, the inverter can be configured and monitored using the EG4® mobile app or the EG4 monitor website.



NOTE:

The dongle should automatically power-on if the inverter is on and the dongle is plugged into the dongle connector. If the Wi-Fi LED is not on, check the physical connection to ensure the dongle is completely seated into the connector on the inverter. The dongle is hot-pluggable, meaning it can be removed and re-inserted with the inverter on.

14.3 CONNECTIVITY REQUIREMENTS

Due to certain limitations of the Wi-Fi Dongle, ensure that the home Wi-Fi network signal and security settings meet the following requirements:

- The Wi-Fi Dongle only supports wireless networks in the 2.4GHz frequency band. If the router supports the 5GHz or 6GHz network frequencies, confirm the router supports the 2.4GHz network frequency band and it is enabled.
- The Wi-Fi Dongle is compatible with WPA1, WPA2, and WPA3 security protocols on the 2.4GHz network only.
- Ensure the Wi-Fi Dongle can obtain an IP Address by verifying the home Wi-Fi router has DHCP (Dynamic Host Configuration Protocol) setup and it is enabled.
- It is recommended the home Wi-Fi network name length does not exceed 19 characters, and the password length does not exceed 24 characters. It is not recommended to use any of the following special symbols in the password: @, #, \$, %, &, *, ?, _, /, or using a space “keyboard space bar”.

14.4 DONGLE PARAMETERS

The dongle network parameters can be used for troubleshooting various configuration and connectivity issues. This section describes the steps to view the dongle parameters along with a brief description for each parameter.

1. Verify the Wi-Fi LED is solid on. If the LED is not on, see section 14.
2. Using an iOS or Android device, connect to the Wi-Fi network created by the dongle, generally it's named as dongle serial number (i.e., BEXXXXXXXXX, BJXXXXXXXX, BGXXXXXXXX).
3. Open the EG4® app and select “Dongle Connect”. Then select “Dongle Connect Params”.
4. The configuration parameters used by the dongle when connecting and communicating over the Wi-Fi network are described below:



NOTE:

If the home screen is bypassed after opening the EG4 app, press the user icon in the upper right of the screen and then select logout.



NOTE:

After selecting Dongle Connect, give the dongle time to respond to the EG4 monitor mobile app. This could take up to 60 seconds based on connectivity strength.

14.5 TROUBLESHOOTING DONGLE NETWORK CONNECTION

ERROR: “SET FAILED” AND/OR “SET PARAMETER FAILED”

- **Description:** This error message may appear after selecting any button in the app that performs an action. For example, selecting the “Home WIFI Connect” button as shown below.
- **Fix:** Confirm the phone is connected to the dongle’s Wi-Fi network and the dongle’s wireless LED is illuminated. If those two conditions are met, wait a few minutes and retry the last step that failed. At times the dongle can become busy or slow to respond to the app.

ERROR: LOST HOTSPOT CONNECTION

- **Description:** This error will occur when there is an issue connecting to the dongle hotspot properly, or the mobile device has disconnected from the dongle hotspot and is trying to connect using the mobile Cellular Network.
- **Fix:** Verify the phone is not set up to connect to a cellular network when Wi-Fi connectivity is poor or is not providing a connection to the internet. The WLAN/Wi-Fi assist can be disabled or the Cellular can be temporarily disabled during the dongle setup process.

TO DISABLE WLAN AND WI-FI ASSIST

- **Android – Select Settings**, select Connections and disconnect the Wi-Fi.
- **iOS – Select Settings**, select Cellular, then scroll to the bottom of the page (screen). Locate “Wi-Fi- Assist” and disable this setting.

14.6 NETWORK SECURITY

ENABLING:

The following steps describe the process of configuring and enabling WPA2 security for the dongle's wireless network:

1. Verify the Wi-Fi LED is solid on. If the LED is not on, see section 14.
2. Using a supported device, connect the Wi-Fi network created by the dongle, generally it's named as dongle serial number (i.e., BEXXXXXXXX, BJXXXXXXX, BGXXXXXXX).
3. Open the EG4® mobile app and select "DONGLE CONNECT". Then select "DONGLE CONNECT PARAMS".

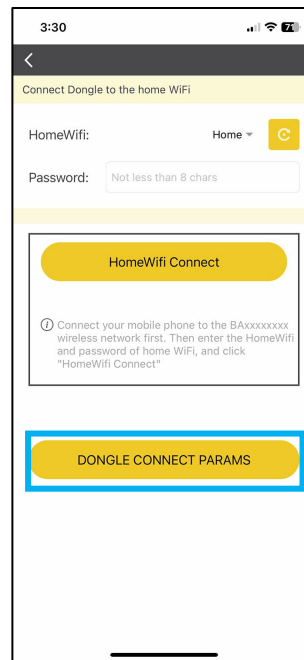
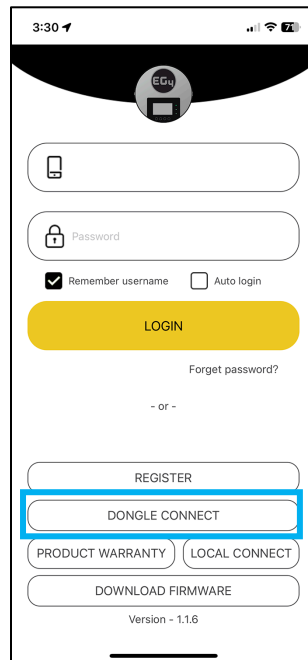
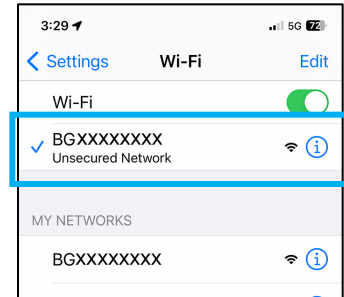

4. Select the Encryption Mode slider to start the configuration process. This step alone will not enable encryption. If the app is closed or the back arrow is pressed to move to the previous screen, this step will need to be completed again.

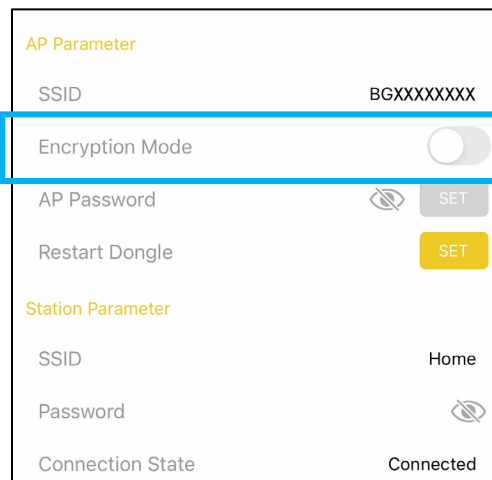

5. Select the “eye” icon and enter the verification code 123123. The “OK” button may need to be selected twice, depending on communication and/or software lag.

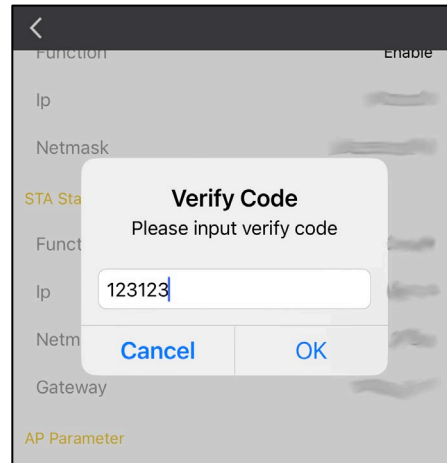
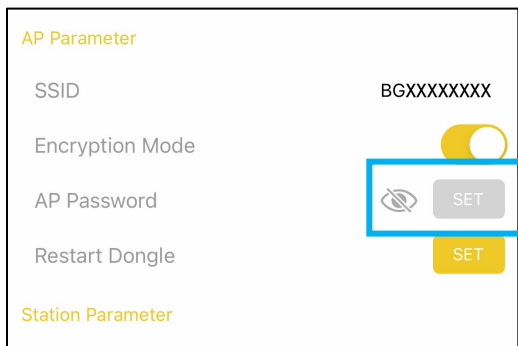

6. The default WPA2 password set at the factory is “12345678”. To change the default password, select inside the password area and overwrite the existing password using the desired password. In the example below, the password is set to “Passw0rd!”.

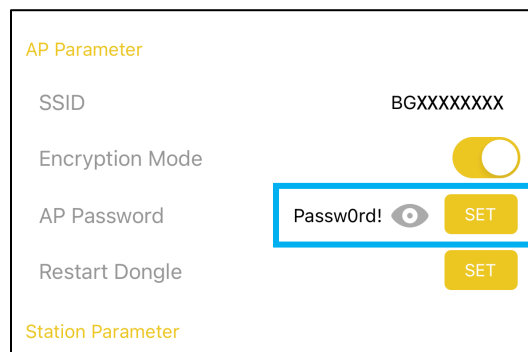

7. Select “SET” to save the password which will also enable WPA2 security. There may be a short pause after selecting the SET button. Press “OK” to verify the setup is complete. The dongle will reboot and should be back online within a couple minutes.

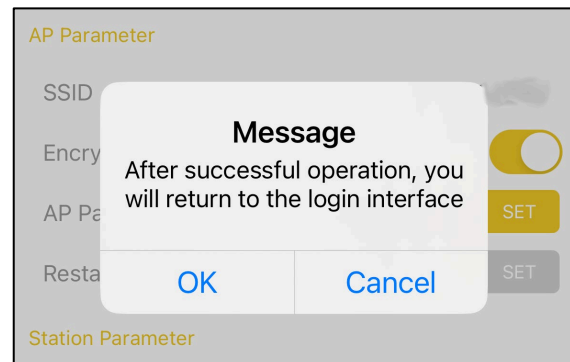
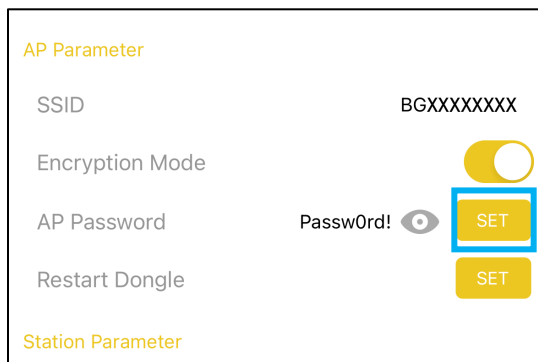

- Go to the phone's Wi-Fi settings and re-select the dongle's Wi-Fi network. The lock icon should appear next to the dongle's wireless network which means security is enabled. Enter the password created in the previous step.

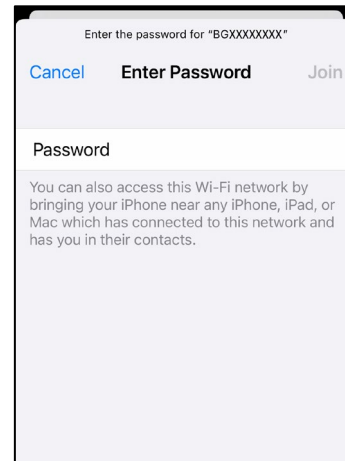
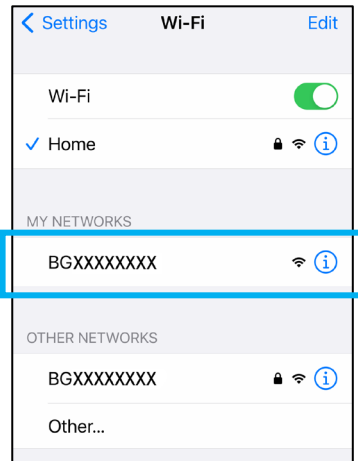

- The EG4® mobile app can now be used as it was previously when security was not enabled. Also note, enabling and setting up WPA2 security on the dongle's Wi-Fi network will not change the dongle's ability to connect to the home Wi-Fi network.

DISABLING:

There are two options to disable the security settings for the dongle's network.

- Option 1:** Hold down the reset button on the bottom of the dongle for at least 10 seconds and release. This is the quickest and easiest option because it does not require using the currently set WPA2 password set on the dongle's Wi-Fi network.
- Option 2:** Use the EG4 App to disable the security settings on the dongle. This option can only be used if the WPA2 password is known. Follow the step list below:
 - Connect a phone to the dongle's Wi-Fi network. If the network was not previously saved on the current phone, enter the dongle's WPA2 password when prompted.
 - Open the EG4 app and select "DONGLE CONNECT".
 - Under the AP Parameter area, select the slider button next to Encryption Mode to disable security.

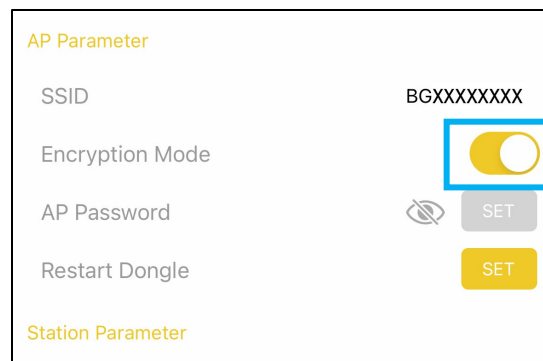

4. Press the “eye” icon and enter the verification code 123123.

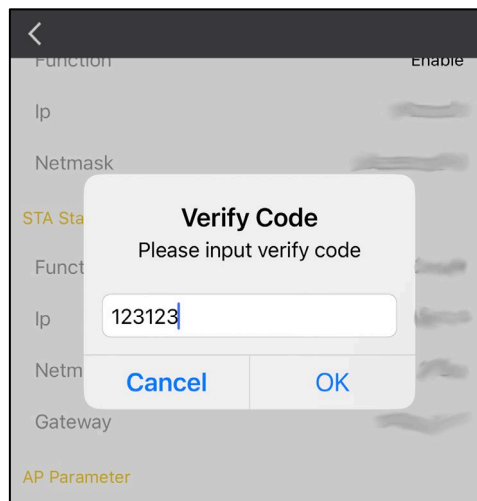
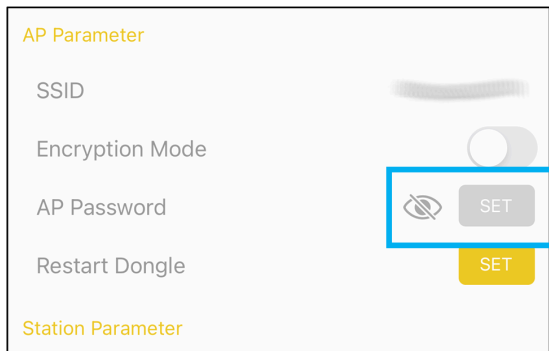

5. Select the “SET” button. There may be a short pause after selecting SET. If this step is not completed, security will NOT be disabled. Press “OK”, when prompted. The dongle will reboot, and security will be disabled after the reboot is complete.

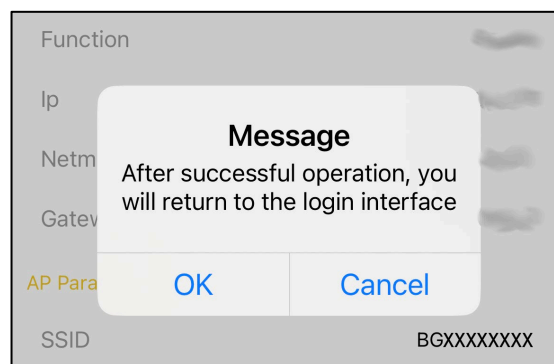
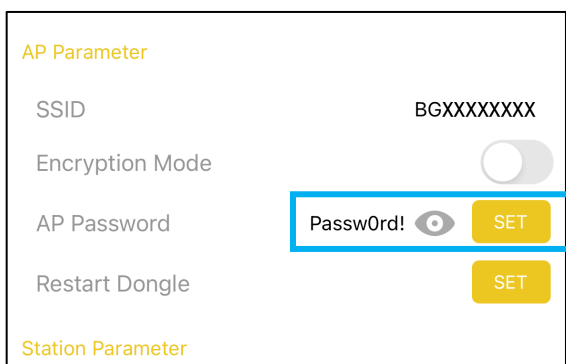

6. When selecting the dongle’s Wi-Fi network, the lock icon should no longer be displayed, and a password should not be required to connect to the dongle’s network.

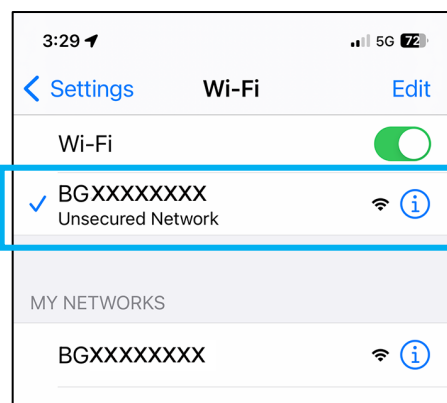

14.7 UPDATE DONGLE FIRMWARE USING APP

Before starting a dongle firmware update, verify all three LEDs are on and the dongle is online and has access to the monitoring server (EG4® Monitor Website). Dongle updates require downloading firmware from the server over the internet. If there are any issues connecting to the monitoring server, refer to section 14.1 and section 14.2. Then connect the phone to the dongle's wireless network.



NOTE:

Before starting a dongle firmware update, verify all 3 LEDs are ON, the dongle is online, and the mobile device is connected to the dongle's Wi-Fi.

1. Connect the mobile device to the dongle's wireless network.
2. Open the EG4® app and select "DONGLE CONNECT".
3. The current dongle firmware will be displayed on the Update firmware button. Select the "Vx.xx Update Firmware" button to start the upgrade process. The EG4 app will automatically locate the latest firmware version available.
4. Select "Vx.x.x UPDATE FIRMWARE" to load the new firmware to the dongle.
5. The dongle FW should immediately load to the dongle. Press "OK" and wait for the dongle to reboot, which should not take more than a couple minutes. Once rebooted, verify the dongle firmware was updated using the dongle connect option in the app, or by using Monitor Center.

15. STANDARDS AND CERTIFICATIONS

The EG4® FlexBOSS18 is cETL listed and complies with national and international standards for safety and reliability when connected to the grid.

SAFETY

- ULSTD.1741,1741SA,1741SB, 1741 PCS CRD
- AFCI NEC 2020:690.11/UL1699B
- GFCI NEC 2020:690.41(B)
- CSA 22.2 #107.1:2016 Ed. 4
- Photovoltaic Rapid Shutdown Systems (R2022) – CSA 22.2 #330:2017 Ed. 1

GRID CONNECTION

- IEEE 1547.1:2020; 1547a:2020; IEEE 1547:2018
- Hawaii Rule 14H [HECO SRD IEEE 1547.1-2020 Ed. 2]
- California Rule 21 Phase I, II, III

EMC

- FCC Part 15 Class B

OUTDOOR RATING

- NEMA 4X

16. CHANGELOG

Ver. 1.1.1

- Renamed “Max Altitude of Operation” to “Operating Altitude”
- Added QR Code for the Monitor Center Video.
- Modified external RSD type to Normally Closed.

Ver. 1.1.0

- Added information regarding inverter derating for higher altitude installations

Ver. 1.0.9

- Added Warning note to section 6.4 page 31

Ver. 1.0.8

- Modified dongle update steps in section 14.7
- Modified battery torque value max in battery connections section 6.4
- Updated spec sheet.
 - Added Design Topology
 - Added MPPT Voltage High Protection and asterisk
- Updated section callouts.
- Deleted most of section 8.

Ver. 1.0.7

- Added standby status to the table in section 15.2
- Added PV Protect High value to spec sheet

Ver. 1.0.6

- Updated “CT Typing” information in conjunction with UL3141 update. See Sect. 6.4.
- Created/Added sections 9 – “Power Control System”, 9.1 – “Export Limiting From all Sources (PEL)”, and 9.2 – “ESS Mode” to cover PCS information.
- Added additional step of setting inverter to standby before full shutdown

Ver. 1.0.5

- Modified Compliance section in Technical Specifications table

Ver. 1.0.4

- Modified max cable size on AC input/output to 2 AWG

Ver. 1.0.3

- Added an asterisk to MPPT Voltage Range line in spec sheet
- Added note after the spec sheet regarding MPPT Voltage Range asterisk

Ver. 1.0.2

- Minor formatting changes for easier readability
- Modified Note quick-part in section 6.4 for updated communication protocol information
- Modified verbiage in section 9.2 for External RSD/ESS Disconnect
- Updated section callouts to reflect document wide changes
- Updated line drawings/renders to reflect latest inverter model
- Updated spec sheet, adding row “Peak Power”
- Modified spacing requirement for above inverter
- Modified unit dimensions in spec sheet and throughout the document:
 - From 30.43 x 22.8 x 11.22 in. (773 x 579 x 285 mm)
 - To 30.43 x 22.28 x 11.22 in. (773 x 566 x 285 mm)
- Update verbiage to reflect spacing requirements
- Modified several tables throughout the document for better readability
- Modified Start-Up Voltage from 200 VDC to 100VDC
- Modified load output minimum voltage from 120VDC to >140VDC

Ver. 1.0.1

- Added French safety section
- Updated spec sheet
 - Added open loop response time
 - Added time to steady state
 - Modified dimensions

Ver. 1.0

- Published



CONTACT US

support@eg4electronics.com

(903) 609-1988

www.eg4electronics.com