

EG4® 12000XP OFF-GRID INVERTER

USER MANUAL



TABLE OF CONTENTS

1.	TECHNICAL SPECIFICATIONS.....	1
2.	ABBREVIATIONS.....	1
3.	INVERTER SAFETY.....	4
3.1	SAFETY INSTRUCTIONS.....	4
3.2	IMPORTANT SAFETY NOTIFICATIONS.....	4
4.	SÉCURITÉ DE L'ONDULEUR.....	6
4.1	INSTRUCTIONS DE SÉCURITÉ.....	6
4.2	NOTIFICATIONS DE SÉCURITÉ IMPORTANTES.....	6
5.	PACKING LIST.....	8
6.	BRIEF INTRODUCTION.....	9
6.1	FEATURES.....	9
6.2	INVERTER INTERFACE.....	10
6.3	CABLE BOX KNOCKOUTS.....	11
6.4	OPERATION OVERVIEW.....	11
7.	PHYSICAL INSTALLATION.....	12
7.1	STORING THE INVERTER.....	12
7.2	LOCATION SELECTION AND INSTALLATION.....	13
7.3	RECOMMENDED TOOLS.....	13
7.4	MOUNTING THE INVERTER.....	14
8.	CABLE CONNECTIONS.....	17
8.1	PV CONNECTIONS.....	17
8.2	BATTERY CONNECTIONS.....	19
8.3	AC CONNECTIONS.....	20
8.4	NEUTRAL-GROUND BONDING.....	22
8.5	GENERATOR CONNECTIONS.....	22
8.6	OFF-GRID.....	25
9.	FIRST TIME POWER UP.....	25
9.1	SINGLE INVERTER.....	26
9.2	MULTIPLE INVERTERS.....	28
10.	RAPID SHUTDOWN/ESS DISCONNECT.....	32
10.1	EXTERNAL RSD.....	32
11.	SMART PORT.....	33
11.1	SMART LOAD.....	33
11.2	AC COUPLING.....	33
12.	FRONT PANEL DISPLAY.....	34
12.1	DISPLAY OVERVIEW.....	34
12.2	INVERTER STATUS.....	35
12.3	WORKING MODES.....	36
12.4	LCD MENU NAVIGATION.....	38
12.5	DATA MENU.....	39
12.6	NOTICE MENU.....	42
12.7	SETTINGS MENU.....	43
13.	REMOTE MONITORING AND CONFIGURATION.....	50
13.1	DONGLE INSTALLATION.....	50
13.2	CREATE A NEW USER ACCOUNT.....	50
13.3	EXISTING USER ACCOUNTS.....	52
14.	MONITOR CENTER SETTINGS.....	54
14.1	COMMON SETTING.....	54
14.2	APPLICATION SETTING.....	55
14.3	CHARGE SETTINGS.....	56
14.4	DISCHARGE SETTINGS.....	58
14.5	OTHER SETTING.....	59
14.6	RESET.....	59
14.7	WORKING MODES.....	59
14.8	FIRMWARE UPDATE.....	60
15.	DONGLE TROUBLESHOOTING.....	61

15.1	LEDS & BUTTON FUNCTIONALITY	61
15.2	DONGLE BOOTUP STEPS	61
15.3	CONNECTIVITY REQUIREMENTS.....	62
15.4	DONGLE PARAMETERS.....	62
15.5	TROUBLESHOOTING DONGLE NETWORK CONFIGURATION.....	64
15.6	NETWORK SECURITY.....	65
15.7	UPDATE DONGLE FIRMWARE USING APP	68
16.	INVERTER TROUBLESHOOTING.....	70
16.1	ERROR DEFINITIONS AND TROUBLESHOOTING	70
16.2	WARNING DEFINITIONS AND TROUBLESHOOTING	71
17.	INVERTER MAINTENANCE	73
17.1	INVERTER START-UP AND SHUT DOWN PROCEDURE	73
18.	WARRANTY INFORMATION	74
19.	CHANGELOG	75

1. TECHNICAL SPECIFICATIONS

AC INPUT DATA	
NOMINAL AC VOLTAGE (GRID GENERATOR)	120/240VAC; 120/208VAC (L1/L2/N required)
FREQUENCY (GRID GENERATOR)	60 Hz (Default) 50 Hz (Configurable)
GRID MAX. CONTINUOUS AC CURRENT	100A @ 240VAC
MAX. AC INPUT POWER	24000W
GENERATOR MAX. CONTINUOUS CURRENT	62.5A @ 240VAC
RECOMMENDED GENERATOR CAPACITY	6000W – 15000W
AC BYPASS (GRID GENERATOR)	100A 90A
AVAILABLE FAULT CURRENT	5kA
INPUT SHORT CIRCUIT CURRENT	150A peak @100us, per inverter
AC OUTPUT DATA	
OUTPUT VOLTAGE	120/240VAC; 208VAC
OUTPUT FREQUENCY	60 Hz (Default) 50 Hz (Configurable)
MAX. CONTINUOUS OUTPUT CURRENT*	62.5A @ 240VAC 57.7A @ 208V
NOMINAL POWER OUTPUT*	w/ PV: 15000W @ 240V 12000W @ 208V w/ out PV: 12000W @ 240V 12000W @ 208V
MAX. CONTINUOUS WATTAGE	12000W (L1-L2) 6000W (L1-N or L2-N)
PEAK POWER (SURGE CAPACITY)**	15360W for ≈10s
POWER FACTOR VALUE	.99
THD (V)	<3%
SWITCHING TIME	<10 ms @ Single / <20 ms @ Parallel
PV INPUT DATA	
NUMBER OF MPPTS	2
INPUTS PER MPPT	2/2
MAX. USABLE INPUT CURRENT	35A/35A
MAX. SHORT CIRCUIT INPUT CURRENT	44A/44A
DC INPUT VOLTAGE RANGE*	100 – 480 VDC
MIN. STARTUP VOLTAGE	100 VDC
MPPT OPERATING VOLTAGE RANGE	120 – 385 VDC
NOMINAL MPPT VOLTAGE	320 VDC
MAX. PV INPUT VOLTAGE**	500 VDC
MAX. UTILIZED SOLAR POWER	24000W (12000 per MPPT)
MAX. RECOMMENDED SOLAR INPUT	28000W (14000 per MPPT)

*15kW nominal power output with model #: IV-15000-XP-IN-01 only. Previous models are limited to 12kW nominal output with max. continuous output current at 50A for 240 VAC, and 57.7A at 208 VAC.

**With battery only.

***When sizing the system, it is best practice to follow the DC Input Voltage Range.

Do not exceed the Max. PV Input Voltage. Any damage caused by reaching >500 VDC will not be covered under warranty.

EFFICIENCY	
MAXIMUM EFFICIENCY (MPPT)	99%
MAXIMUM EFFICIENCY (PV TO BATTERY)	92.8%
MAXIMUM EFFICIENCY (AC TO BATTERY)	92.5%
MAXIMUM EFFICIENCY (PV TO LOADS)	93.5%
MAXIMUM EFFICIENCY (BATTERY TO LOADS)	90.2%
IDLE CONSUMPTION (STANDBY MODE)*	<70W
BATTERY DATA	
COMPATIBLE TYPES	Lead-Acid/Lithium
MAX. CHARGE/DISCHARGE CURRENT (A)	250A
MAX. CHARGE/DISCHARGE POWER (W)	12000W
NOMINAL VOLTAGE	48 VDC
BATTERY VOLTAGE RANGE	46.4 – 60 VDC (Lithium) 38.4 – 60 VDC (Lead-Acid)
RECOMMENDED BATTERY CAPACITY PER INVERTER	>400Ah
HIGH DC CUT-OFF VOLTAGE	59 VDC (Lithium) 60 VDC (Lead-acid)
GENERAL DATA	
MAX. UNITS IN PARALLEL	16
PRODUCT DIMENSIONS (H×W×D)	34.25×20.87×5.91 in. (870×530×150 mm)
UNIT WEIGHT	104.7 lbs. (47.5 kg)
DESIGN TOPOLOGY	High Frequency - Transformerless
RELATIVE HUMIDITY	5 – 95% (non-condensing)
OPERATING ALTITUDE	<6561 ft. (<2000 m)
OPERATING AMBIENT TEMPERATURE RANGE	32°F – 113°F (0°C – 45°C) @ Full Load
STORAGE AMBIENT TEMPERATURE RANGE	5°F – 140°F (-15°C – 60°C)
NOISE EMISSION (TYPICAL)	<60 dB
LOCKED ROTOR AMPS (LRA)	195A
COOLING METHOD	Fan
COMMUNICATION INTERFACE	RS485/CAN/Wi-Fi
STANDARD WARRANTY**	5-year standard warranty
INGRESS PROTECTION RATING	IP20
SAFETY FEATURES	PV Reverse Polarity Protection, Surge Protection Device, Output Over-Voltage Protection, Output Over-Voltage Protection Varistor
STANDARDS AND CERTIFICATIONS	
UL1741	
FCC PART 15, CLASS B	

*Idle consumption value tested with constant 300 VDC PV source

**For information regarding warranty registration on EG4® Electronics products, please navigate to <https://eg4electronics.com/warranty/> and select the corresponding product to begin the registration process.

2. ABBREVIATIONS

- AWG – American Wire Gauge
- A – Amps
- Ah – Amp hour(s)
- AC – Alternating Current
- AFCI – Arc-Fault Circuit Interrupter
- AHJ – Authority Having Jurisdiction
- kAIC – kilo-Amp Interrupting Capability
- ANSI – American National Standards Institute
- BAT – Battery
- BMS – Battery Management System
- COM – Communication
- CT – Current Transformer
- DC – Direct Current
- DIP – Dual In-line Package
- DOD – Depth of Discharge
- EG – Equipment Ground
- EGS – Equipment Grounding System
- EMC – Electromagnetic Compatibility
- EPS – Emergency Power System
- ESS – Energy Storage System
- E-Stop – Emergency Stop
- FCC – Federal Communication Commission
- GE – Grounding Electrode
- GEC – Grounding Electrode Conductor
- GFCI – Ground Fault Circuit Interrupter
- GFDI – Ground Fault Detector/Interrupter
- Imp – Maximum Power Point Current
- IEEE – Institute of Electrical and Electronic Engineers
- IP – Ingress Protection
- I_{sc} – Short-Circuit Current
- In-lbs. – Inch Pounds
- kW – Kilowatt
- kWh – Kilowatt-hour
- LCD – Liquid Crystal Display
- LFP – Lithium Iron Phosphate
- L1 – Line 1
- L2 – Line 2
- mm – Millimeters
- MPPT – Maximum Power Point Tracking
- mV – Millivolt
- N – Neutral
- NEC – National Electric Code
- NEMA – National Electrical Manufacturers Association
- NFPA – National Fire Prevention Association
- Nm – Newton Meters
- NOCT – Normal Operating Cell Temperature
- PC – Personal Computer
- PCB – Printed Circuit Board
- PE – Protective Earth
- PPE – Personal Protective Equipment
- PV – Photovoltaic
- RSD – Rapid Shut Down
- SCC – Standards Council of Canada
- SOC – State of Charge
- STC – Standard Testing Conditions
- UL – Underwriters Laboratories
- UPS – Uninterrupted Power Supply
- V – Volts
- VOC – Open-Circuit Voltage
- VMP – Voltage Maximum Power

3. INVERTER SAFETY

3.1 SAFETY INSTRUCTIONS

International safety regulations have been strictly observed in the design and testing of the inverter. Before beginning any work, carefully read all safety instructions, and always observe them when working on or with the inverter. The installation must follow all applicable national or local standards and regulations.

Incorrect installation may cause:

- Injury or death to the installer, operator or third party
- Damage to the inverter or other attached equipment

3.2 IMPORTANT SAFETY NOTIFICATIONS



DANGER: *Hazardous Voltage Circuits!*

There are various safety concerns that must be carefully observed before, during, and after the installation, as well as during future operation and maintenance. The following are important safety notifications for the installer and any end users of this product under normal operating conditions.

1. **Beware of high PV voltage.** Install an external DC disconnect switch or breaker and ensure it is in the “off” or “open” position before installing or working on the inverter. Use a voltmeter to confirm there is no DC voltage present to avoid electric shock.
2. **Beware of high grid voltage.** Ensure the AC switch and/or AC breaker are in the “off” or “open” position before installing or working on the inverter. Use a voltmeter to confirm there is no voltage present to avoid electric shock.
3. **Beware of high battery current.** Ensure that the battery module breakers and/or on/off switches are in the “open” or “off” position before installing or working on the inverter. Use a voltmeter to confirm there is no DC voltage present to avoid electric shock.
4. **Do not open the inverter while it is operating to avoid electric shock and damage from live voltage and current within the system.**
5. Do not make any connections or disconnections (PV, battery, grid, communication, etc.) while the inverter is operating.
6. An installer should make sure to be well protected by reasonable and professional insulative equipment [e.g., personal protective equipment (PPE)].
7. Before installing, operating, or maintaining the system, it is important to inspect all existing wiring to ensure that it meets the appropriate specifications and conditions for use.
8. Ensure that the PV, battery, and grid connections to the inverter are secure and proper to prevent damage or injuries caused by improper installation.
9. Some components of the system can be very heavy. Be sure to utilize team lift and other safe lifting techniques throughout the installation.



WARNING: TO REDUCE THE RISK OF INJURY, READ ALL INSTRUCTIONS!

All work on this product (system design, installation, operation, setting, configuration, and maintenance) must be carried out by qualified personnel. To reduce the risk of electric shock, do not perform any servicing other than those specified in the operating instructions unless qualified to do so.

10. Read all instructions before installing. For electrical work, follow all local and national wiring standards, regulations, and these installation instructions.
11. Make sure the inverter is properly grounded. All wiring should be in accordance with the National Electrical Code (NEC), ANSI/NFPA 70.
12. The inverter and system can inter-connect with the utility grid only if the utility provider permits. Consult with the local AHJ (Authority Having Jurisdiction) before installing this product for any additional regulations and requirements for the immediate area.
13. All warning labels and nameplates on the inverter should be clearly visible and must not be removed or covered.
14. The installer should consider the safety of future users when choosing the inverter's correct position and location as specified in this manual.
15. Keep children from touching or misusing the inverter and relevant systems.
16. **Beware!** The inverter and some parts of the system can be hot when in use. Do not touch the inverter's surface or most of the parts when they are operating. During operation, only the LCD and buttons should be touched.



WARNING!

Cancer and Reproductive Harm – See www.P65Warnings.ca.gov for more details.

DISCLAIMER

EG4 reserves the right to make changes to the material herein at any time without notice. Please refer to www.eg4electronics.com for the most updated version of our manuals/spec sheets.

4. SÉCURITÉ DE L'ONDULEUR

4.1 INSTRUCTIONS DE SÉCURITÉ

Les réglementations internationales de sécurité ont été strictement observées lors de la conception et des tests de l'onduleur. Avant de commencer tout travail, lisez attentivement toutes les instructions de sécurité et respectez-les toujours lorsque vous travaillez sur ou avec l'onduleur. L'installation doit suivre toutes les normes et réglementations nationales ou locales applicables. Consultez l'autorité locale compétente et/ou le fournisseur d'électricité pour obtenir les permis et autorisations nécessaires avant l'installation.

Une installation incorrecte peut causer:

- Des blessures ou la mort de l'installateur, de l'opérateur ou d'un tiers
- Des dommages à l'onduleur ou à d'autres équipements connectés

4.2 NOTIFICATIONS DE SÉCURITÉ IMPORTANTES



DANGER: *Circuits à haute tension!*

Il y a divers problèmes de sécurité qui doivent être soigneusement observés avant, pendant et après l'installation, ainsi que pendant l'exploitation et la maintenance futures. Les notifications de sécurité suivantes sont importantes pour l'installateur et tout utilisateur final de ce produit dans des conditions normales de fonctionnement.

1. **Attention à la haute tension PV.** Installez un interrupteur ou disjoncteur externe de déconnexion DC et assurez-vous qu'il est en position "off" ou "ouvert" avant d'installer ou de travailler sur l'onduleur. Utilisez un voltmètre pour confirmer qu'il n'y a pas de tension DC présente afin d'éviter les chocs électriques.
2. **Attention à la haute tension du réseau.** Assurez-vous que l'interrupteur AC et/ou le disjoncteur AC sont en position "off" ou "ouvert" avant d'installer ou de travailler sur l'onduleur. Utilisez un voltmètre pour confirmer qu'il n'y a pas de tension présente afin d'éviter les chocs électriques.
3. **Attention au courant élevé de la batterie.** Assurez-vous que les disjoncteurs des modules de batterie et/ou les interrupteurs on/off sont en position "ouvert" ou "off" avant d'installer ou de travailler sur l'onduleur. Utilisez un voltmètre pour confirmer qu'il n'y a pas de tension DC présente afin d'éviter les chocs électriques.
4. **Ne pas ouvrir l'onduleur pendant qu'il fonctionne pour éviter les chocs électriques et les dommages dus à la tension et au courant en direct dans le système.**
5. Ne pas effectuer de connexions ou de déconnexions (PV, batterie, réseau, communication, etc.) pendant que l'onduleur fonctionne.
6. Un installateur doit s'assurer d'être bien protégé par un équipement isolant raisonnable et professionnel (par exemple, équipement de protection individuelle (EPI)).
7. Avant d'installer, d'exploiter ou de maintenir le système, il est important d'inspecter tous les câblages existants pour s'assurer qu'ils répondent aux spécifications et conditions appropriées pour l'utilisation.
8. Assurez-vous que les connexions PV, batterie et réseau à l'onduleur sont sécurisées et appropriées pour éviter les dommages ou les blessures causés par une installation incorrecte.
9. Certains composants du système peuvent être très lourds. Assurez-vous d'utiliser des techniques de levage en équipe parmi d'autres techniques de levage sûres tout au long de l'installation.



AVERTISSEMENT : POUR RÉDUIRE LE RISQUE DE BLESSURE, LISEZ TOUTES LES INSTRUCTIONS !

Tous les travaux sur ce produit (conception du système, installation, exploitation, réglage, configuration et maintenance) doivent être effectués par du personnel qualifié. Pour réduire le risque de choc électrique, ne réalisez aucun entretien autre que ceux spécifiés dans les instructions de fonctionnement, sauf si vous êtes qualifié pour le faire.

10. Lisez toutes les instructions avant d'installer. Pour les travaux électriques, suivez toutes les normes et réglementations locales et nationales de câblage, ainsi que ces instructions d'installation.
11. Assurez-vous que l'onduleur est correctement mis à la terre. Tous les câblages doivent être conformes au Code National de l'Électricité (NEC), ANSI/NFPA 70.
12. L'onduleur et le système peuvent se connecter au réseau électrique uniquement si le fournisseur d'électricité le permet. Consultez l'autorité locale compétente avant d'installer ce produit pour toute réglementation et exigence supplémentaire pour la zone immédiate.
13. Toutes les étiquettes d'avertissement et les plaques signalétiques sur l'onduleur doivent être clairement visibles et ne doivent pas être retirées ou couvertes.
14. L'installateur doit tenir compte de la sécurité des futurs utilisateurs lors du choix de la position et de l'emplacement corrects de l'onduleur, comme spécifié dans ce manuel.
15. Empêchez les enfants de toucher ou de mal utiliser l'onduleur et les systèmes pertinents.
16. **Attention !** L'onduleur et certaines parties du système peuvent être chauds lorsqu'ils sont utilisés. Ne touchez pas la surface de l'onduleur ou la plupart des pièces lorsqu'elles fonctionnent. Pendant le fonctionnement, seuls l'écran LCD et les boutons doivent être touchés.



AVERTISSEMENT !

Cancer et dommages reproductifs – Voir www.P65Warnings.ca.gov pour plus de détails.

DISCLAIMER

EG4® se réserve le droit de modifier le contenu de ce document à tout moment sans préavis. Veuillez consulter www.eg4electronics.com pour la version la plus récente de nos manuels/fiches techniques.

5. PACKING LIST

When the product is unpackaged, the contents should match those listed below.

Note: Pictures are for reference only.

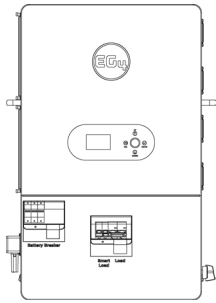

12000XP Off-Grid Inverter

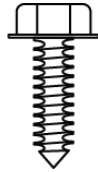

Hex Head Wood Lag Screw (x6)



Expansion Bolts (x6)

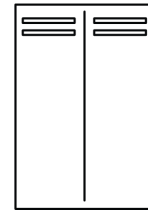

Cardboard Template

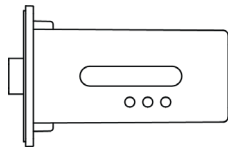

Wi-Fi Dongle

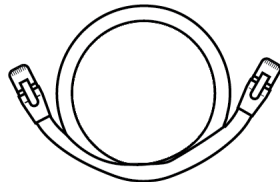

Parallel Communication Cable L=2m x 1 (Grey)

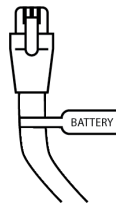

Battery Communication Cable L=2m x 1 (Orange)



Phillips Hex Head Bolt M5 (x4)

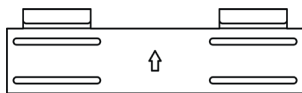

Wall Mounting Bracket

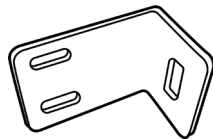

L Bracket (x2)



Phillips Hex Head Bolt (x4)



Phillips Hex Head Bolt M6 (x8)

6. BRIEF INTRODUCTION

The EG4® 12000XP is a 15kW* 120/240VAC split-phase, all-in-one, off-grid, sine wave inverter with grid charge capability designed for the residential and small commercial markets. The 12000XP can receive 28kW of DC (STC) solar PV on two 35A MPPTs and generate 15kW* of power and can feed through 24kW (100A) of utility or 62.5A of generator split phase 120/240V AC power. The 12000XP has full generator support, 2-wire start/stop auto-start and full-featured generator support software. It also features a programmable smart port that supports either smart load control or AC coupled input up to 63A.

6.1 FEATURES

- Applicable for purely off-grid or on-grid backup power situations.
- 2 MPPT solar charge controllers, each supporting PV input of 480V with an optimal range of 120 – 385 VDC.
- Each MPPT has 2 paralleled inputs that support up to 12kW usable PV (14kW max input), for a total of 24kW usable PV (28kW max input) when both MPPTs are utilized.
- PV Arc Fault Protection and PV Reverse Polarity Protection.
- Rated for 15kW* output, with a power factor of 0.99.
- Able to run with or without battery in off-grid mode.
- Full generator support.
- Supports up to 16 inverters in parallel for up to 192kW** of power to run loads.
- Supports CAN/RS485 for lithium battery communications.
- Features remote monitoring and firmware updates via EG4 mobile app or Monitor Center website.

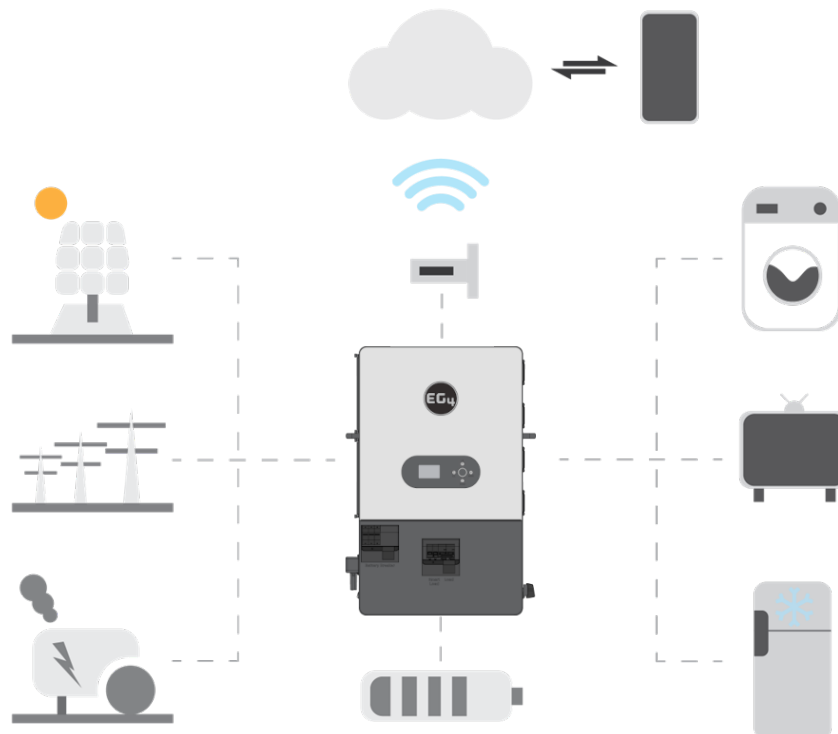

*15kW nominal power output with model #: IV-15000-XP-IN-01 only. Previous models are limited to 12kW nominal output with max. continuous output current at 50A for 240 VAC, and 57.7A at 208 VAC.

**240kW nominal power output using max number of inverters in parallel with only model #: IV-15000-XP-IN-01

6.2 INVERTER INTERFACE

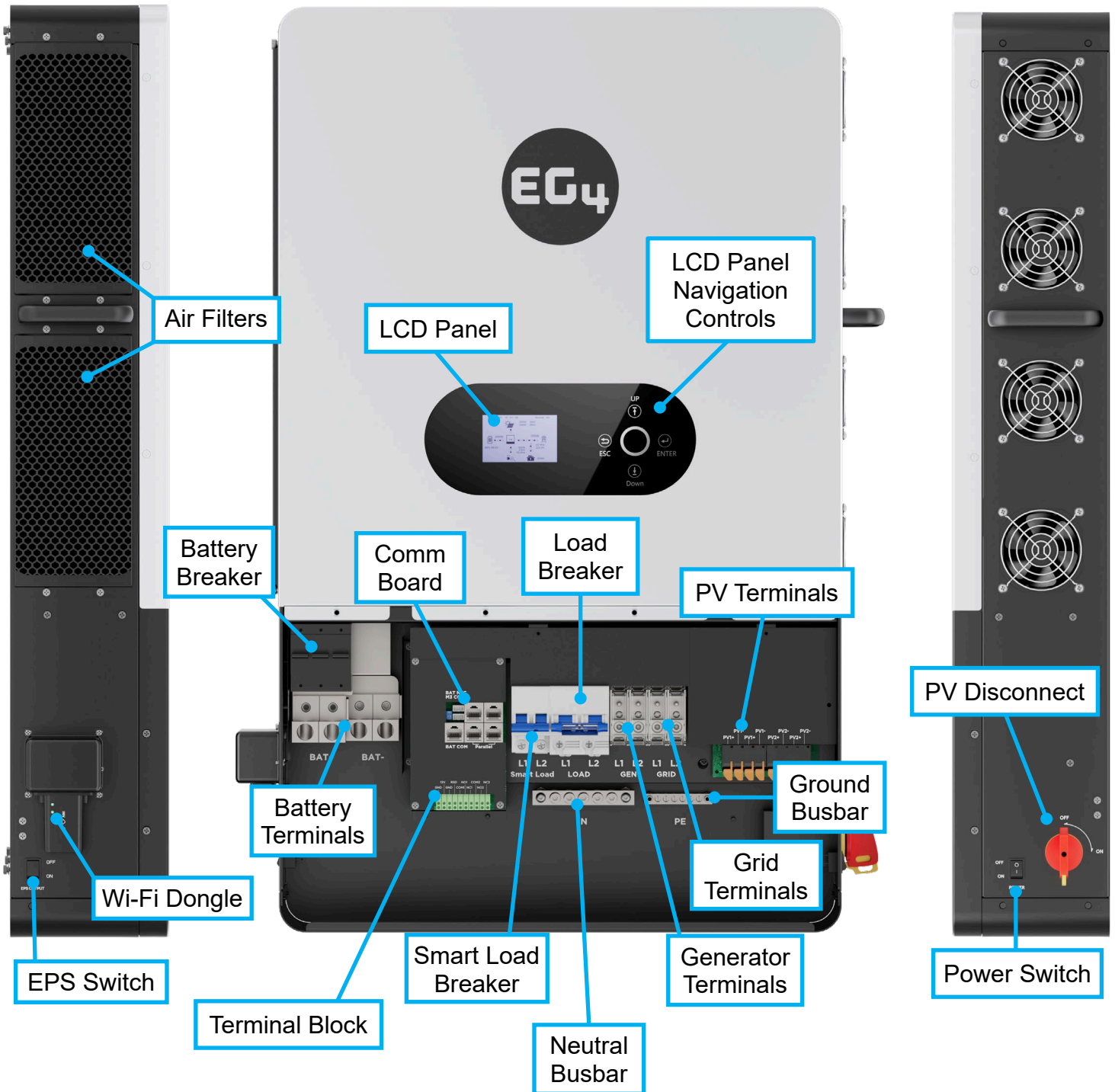

6.3 CABLE BOX KNOCKOUTS

The image below represents the bottom view of the cable box area with knockout hole sizing shown in nominal trade sizes.

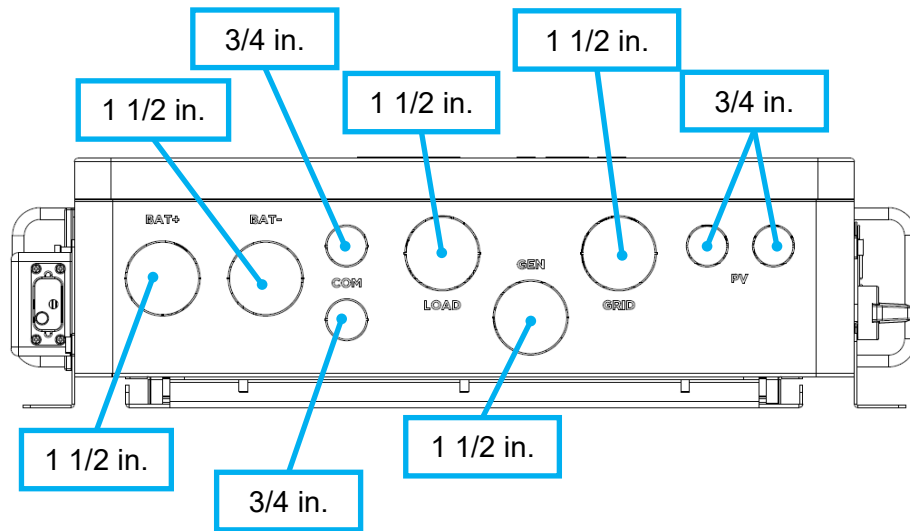

U.S. NOM. TRADE SIZE	ACTUAL KO SIZE
1/2 in.	0.88 in. (22.2 mm)
3/4 in.	1.11 in. (28.2 mm)
1 in.	1.38 in. (34.9 mm)
1-1/4 in.	1.73 in. (44.0 mm)
1-1/2 in.	1.98 in. (50.4 mm)
2 in.	2.47 in. (62.7 mm)

6.4 OPERATION OVERVIEW

The information below provides a high-level overview of the general operation of the inverter.

- This is an off-grid inverter that does not have the ability to sell power back to the grid but can utilize grid power for battery charging and pass-through to loads.
- For the inverter to power on, it must be connected to a supported DC and/or AC power source. The minimum supported voltage for each source must be met as described in the technical specifications table.
- When the inverter's power switch on the right side of the unit is moved to the "on" position, the front display will illuminate; the inverter can be configured using the front display. The inverter must be set up for Wi-Fi connectivity before remote software can be used.
- The "EPS" switch, found on the left side of the inverter, controls the output current to the "Load" terminals. Once the "EPS" switch is set to the "on" position, the "Load" terminals can output current.
- The "Smart Load" terminal is controlled by software and can output current based on user configured time and/or set conditions or accept an existing AC coupled system.
- If PV or battery voltage is present, the inverter can output current to the "Load" or "Smart Load" terminals as determined by the configuration of the front panel or remote software.
- To stop AC output on the load terminals, either turn the EPS switch to the "off" position, turn the load or smart load breaker to the "off" position, or use the Emergency Stop button if equipped.

7. PHYSICAL INSTALLATION

7.1 STORING THE INVERTER

If placing the inverter into storage before installation, keep the following factors in mind while selecting a storage location.



CAUTION:

- *The inverter and its components must be stored in its original packaging.*
- *The temperature for the storage area should be within -13 – 140°F (-25 – 60°C) and humidity within 0 – 85%.*
- *The packaging should be upright with a maximum of 7 stacked layers.*
- *Do not directly expose the inverter and its packaging to sunlight or rain and keep away from corrosion.*

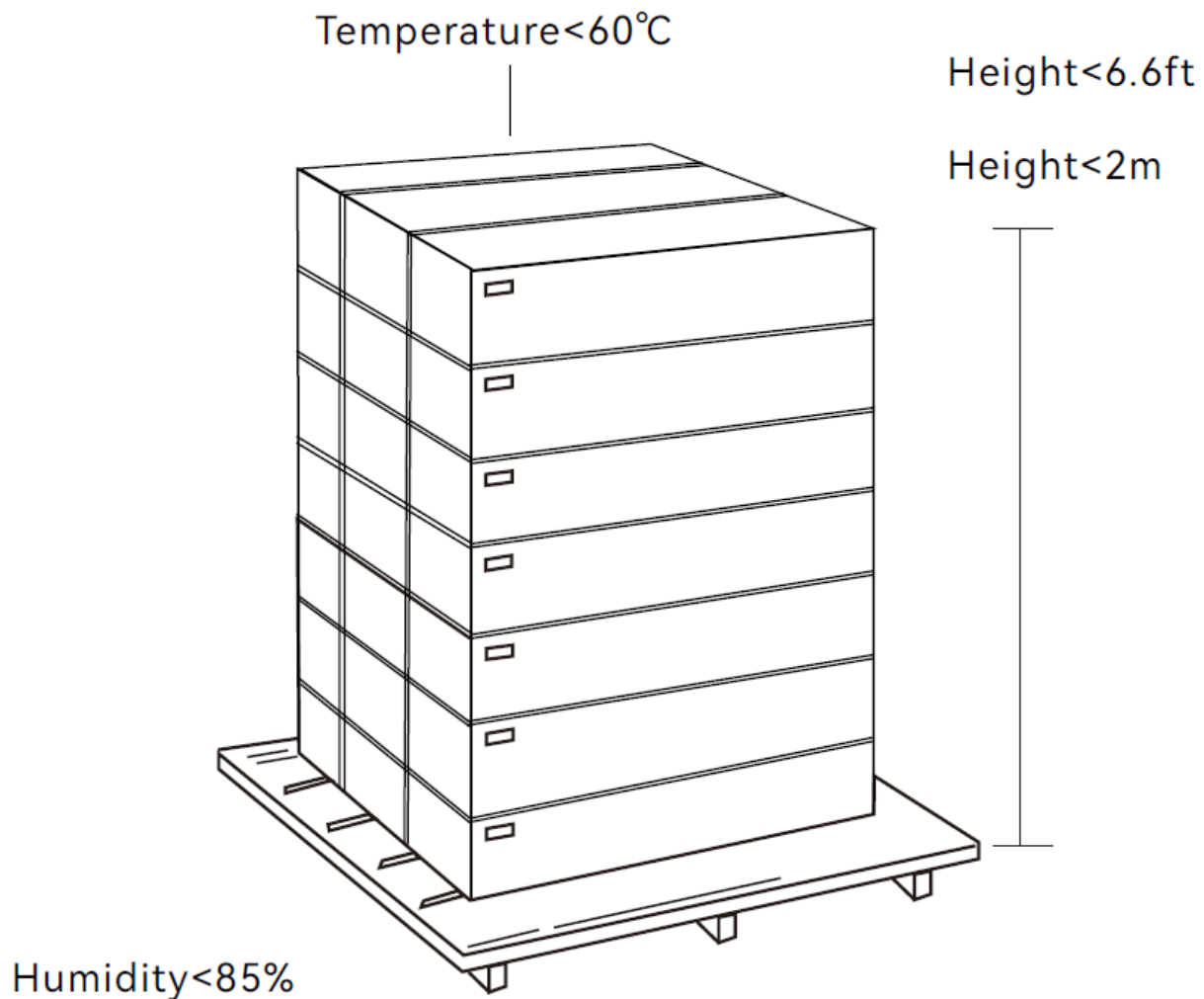

7.2 LOCATION SELECTION AND INSTALLATION

- The mounting wall should be strong enough to bear the weight of the inverter.
- Maintain the minimum clearances presented to the right for adequate heat dissipation.
- Install the inverter upright on a vertical surface.
- Ensure the mounting surface is made of non-combustible materials.

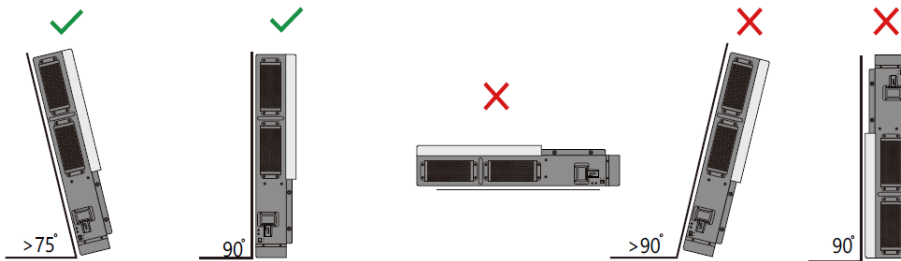
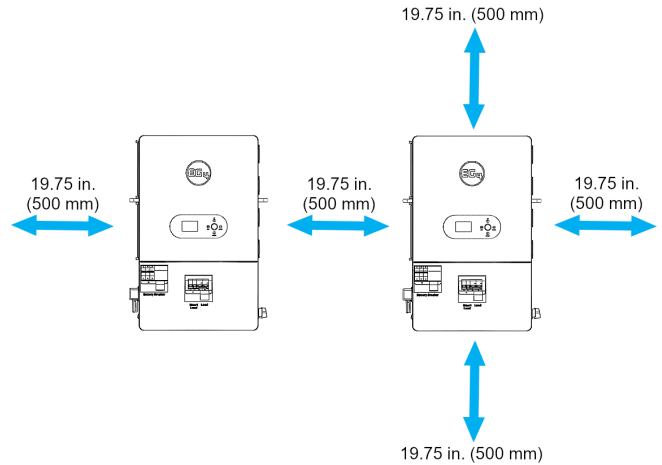

7.3 RECOMMENDED TOOLS



7.4 MOUNTING THE INVERTER

The inverter is designed to be vertically wall-mounted on a solid, **non-combustible** material such as brick or concrete. Two or more people may be needed to install the inverter due to its weight (≈ 104.7 lbs.). The inverter is wall mounted using a wall mount bracket. The slots on the mounting bracket can accommodate various stud spacings from 12 inches (305 mm) to 16 inches (406 mm), as shown in the image below.

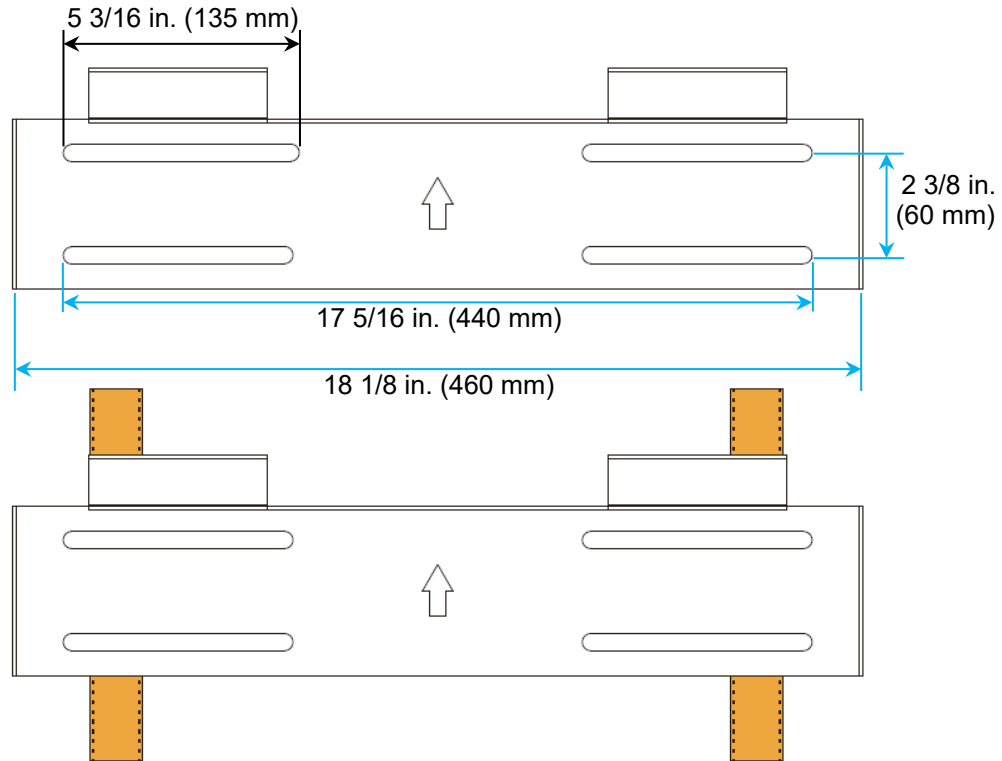

NOTE:

- **Ensure the surface the inverter is being mounted to can support the weight of the unit and has proper spacing as per the diagram above.**

Mounting Steps:

1. Select a suitable mounting location for the inverter.
2. Use the cardboard template to mark where the mounting bracket bolts or screws will be installed. When installing the bracket to studs, verify the marks for the screws are centered over a stud.

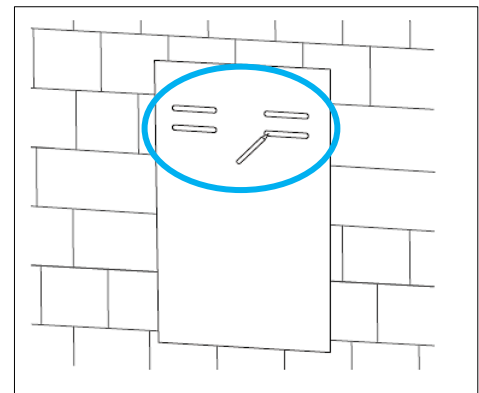

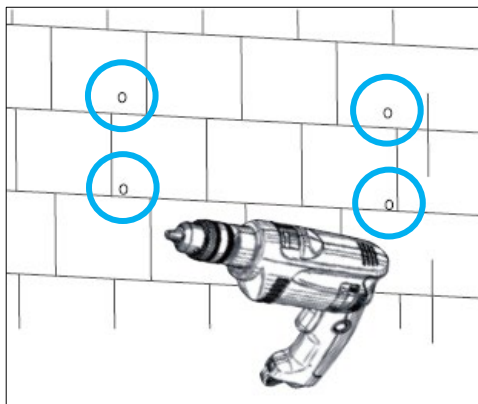

3. When installing the bracket to concrete or brick, drill 5/16 in. (8 mm) diameter holes on the marks, making sure the holes are deeper than 2 in. (50 mm) when using the included expansion bolts. When installing the bracket to a stud, drill a pilot hole recommended for the screw diameter used.

4. For concrete or brick wall installation, insert the expansion bolts into the drilled holes. Install the bracket to the wall ensuring the arrow is pointing up. Use the corresponding nuts and washers (packaged together with the expansion bolts) to affix the bracket to the wall. For stud wall installation, insert four of the included hex head wood lag screws into the pilot holes and affix the bracket to the wall.

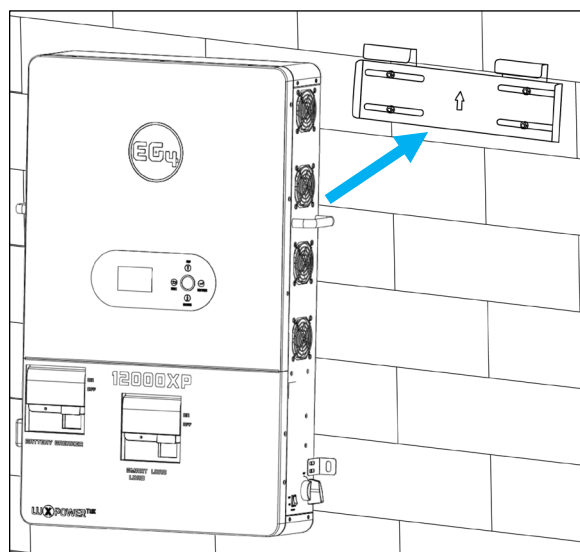
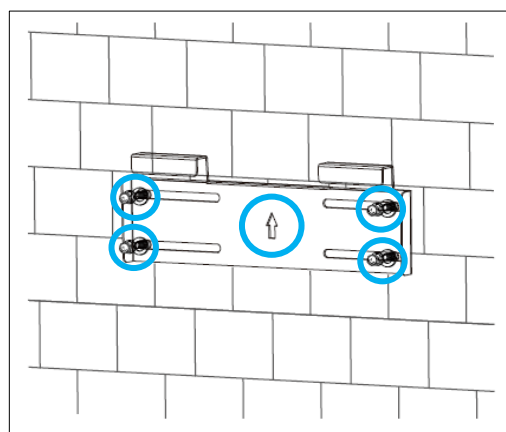

5. Using the team-lift technique, place the inverter on to the wall bracket securing it to the wall.

6. Temporarily mount the L bracket to the side of the inverter (located at the bottom, one on each side). Mark a hole on the wall based on the hole location inside the right-angle bracket (repeat this step for both sides).

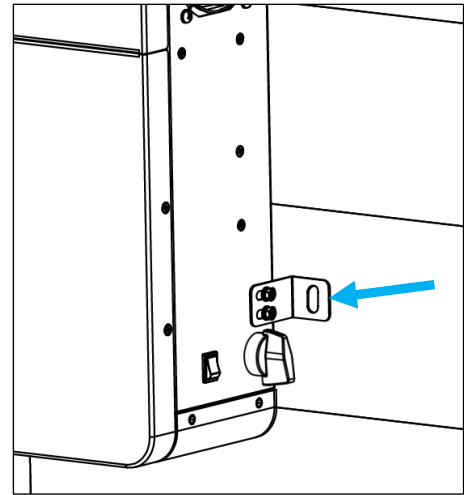
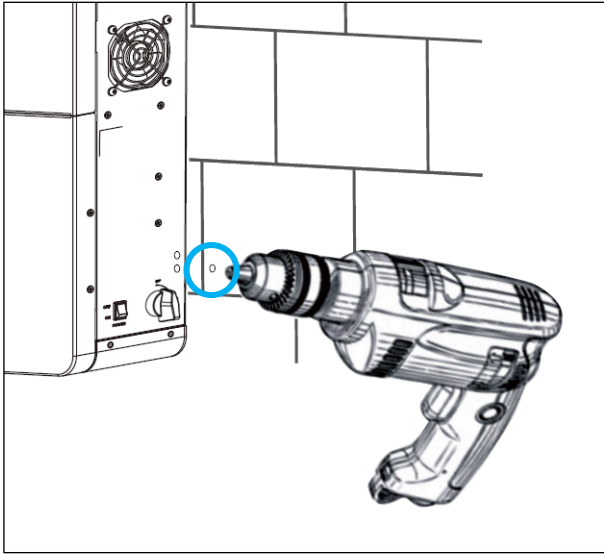

7. Remove the L bracket and drill a hole at the marking. Use the drill bit size based on the anchor type or screw size as directed in step 3 (repeat this step for both sides).

8. Attach the L brackets (one on each side) to the inverter and to the wall using the correct hardware. Once the bracket is secure, the wall installation is complete.

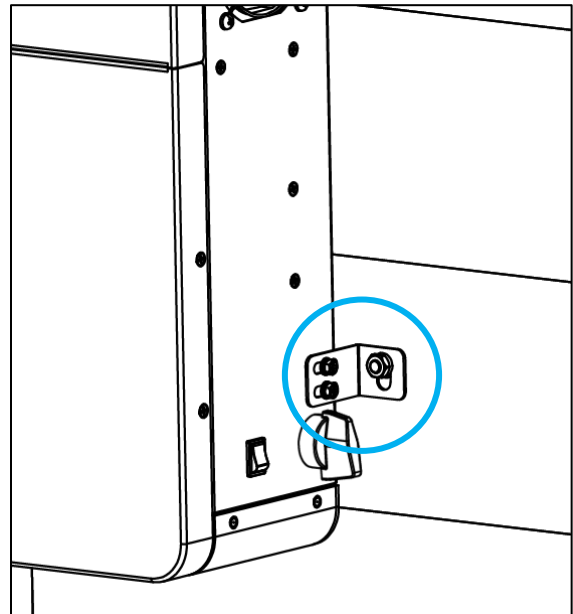

8. CABLE CONNECTIONS

To expose the cable box area, remove the bottom cover by removing the 4 screws identified in the image below. Once the cover is removed, follow the sections below for connecting the wiring for PV, AC, Battery, Generator, RSD, and Parallel cables. Before connecting any wiring to the inverter, verify each wire is not carrying voltage using a multimeter.

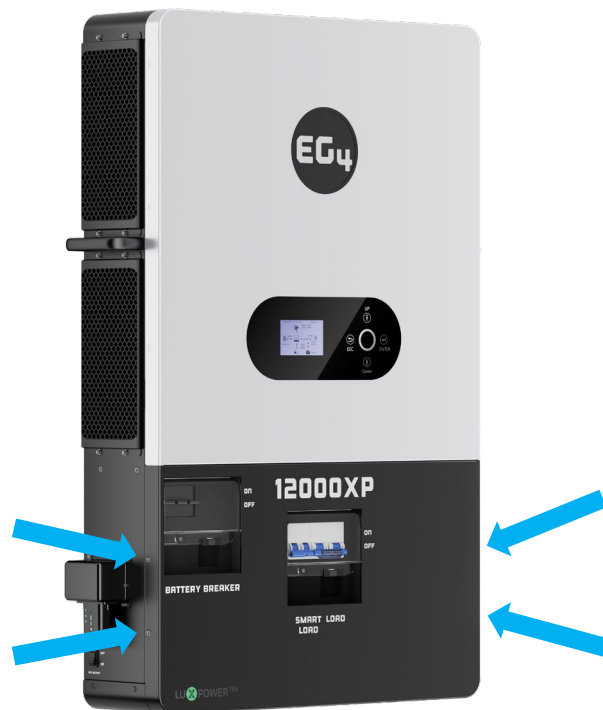

8.1 PV CONNECTIONS

The inverter is equipped with two MPPT controllers, each with 2 sets of connectors per controller. The two inputs can support two strings as individual serial strings or combined as a single parallel string.

The inverter has two separate MPPTs which will use up to 35A each. Likewise, two strings can be paralleled for any modules having less than 17.5A (Imp) rating.

PV CABLE SIZE	MIN. PV DISCONNECT/ISOLATOR SPEC	TORQUE SPECS
10 AWG – 6 AWG (Max) (6 mm ² – 16 mm ²)	600V/40A	10.6 in-lbs. (1.2Nm)



NOTE:

When connecting multiple inverters in parallel, a single string cannot be shared between inverters.



CAUTION:

The array may have a higher Imp than the 35A specified, but the MPPTs will not make full use of the extra current and may lead to internal component deterioration over time.

String Sizing

When solar modules are put in a series string, the voltage multiplies by the number of modules and the amperage stays the same as the rating of each module.

For example: Using solar modules that have a 40 VDC VOC (77°F) with a Max Power current of 10 amps (Imp) - 10 modules wired in a series string would have a VOC of 400 VDC (77°F) and a string amperage of 10 amps. When the temperature lowers, the voltage can rise above the maximum allowed by the MPPT and damage will result.

Finally, calculate the maximum current of the string so as not to exceed the inverter's MPPT circuit ratings. Double check if the calculated VMP range is within the 120 – 385 VDC optimal MPPT circuit operating range.



DANGER:

Damage WILL occur if the string voltage exceeds the inverter's maximum input voltage of 480 VDC! All string sizing calculations should be performed using a sizing calculator or by consulting a professional solar designer/installer.

Please visit the [EG4 Solar Panel String Sizer](#) tool for assistance.

All panels in a series/parallel string should face the same orientation and be exposed to roughly the same shading across the string. Consideration should be placed on string location and wiring order on the racking to minimize shading effects. One shaded module can disproportionately reduce output for the entire string. This is because shading on a solar module will cause a drop in voltage. All panels in a string will drop to match the lowest voltage experienced in any module. Using Optimizers and/or use string geometries that account for how the shading patterns affect partial shading of the string.

Cable Installation:

1. Before installing PV wiring to the inverter, ensure all breakers and disconnects are in the open (OFF) position. Confirm each PV string (negative and positive wire pair) has no DC voltage using a multimeter. Once verified, continue to step 2.
2. Strip off 4/5 in. (20 mm) insulation from the PV strings' positive and negative wires. When using fine stranded wire, use ferrules to secure the connections to the inverter.
3. Route the PV wire through the knockouts and into the inverter.
4. Locate the orange tabs and press "up" to lock them into an open position. Secure the PV wiring in place into their respective terminals and press "down" on the tabs to lock them in position. Verify the cables are secure by lightly tugging on them.
5. Ensure the conduit is fastened reliably, and the cable entry holes are sealed.
6. Once cabled, each MPPT controller must be configured as single or combined on the LCD display panel or in the Monitor Center (see step 9 in section 9.1 to configure the MPPTs).

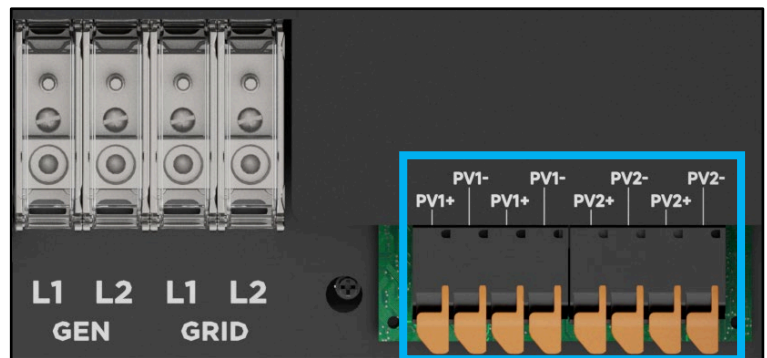

8.2 BATTERY CONNECTIONS

The EG4® 12000XP supports connecting to lithium or lead-acid batteries. There is a combination of settings that need to be configured depending on the battery type installed. When using lithium batteries, it is recommended to configure the battery to communicate with the inverter using the included battery communications cable. Attaching the communications cable allows the inverter to communicate with the BMS inside the battery and is referred to as closed-loop communication. If the communications cable is not attached, open-loop communication is used, and the inverter relies on using voltage readings from the batteries. See the installation steps below for more information.



IMPORTANT:

The inverter needs a minimum 400Ah of battery capacity to support the output specifications!

For safe operation and regulation compliance, install a separate DC over-current protector or disconnect device between battery and inverter.



CAUTION:

Use the proper cable size when connecting the inverter to the battery. See the chart below for the recommended wire sizes.

INTEGRATED BREAKER	MAXIMUM AMPERAGE	BATTERY CAPACITY	CABLE SIZE	MAX. TORQUE VALUES
300A	250A	400Ah	2/0 AWG (x2)	200 in-lbs. (22.6Nm)
300A	250A	400Ah	4/0 AWG (x1)	250 in-lbs. (28.2Nm)

Cable Installation

1. Verify all breakers are in the open (OFF) position before connecting or disconnecting wires. Using a multimeter, ensure that there is no DC voltage present at the inverter breaker and the battery cables if they are already connected to the battery or battery bank. Verify the PV switch is in the off position.
2. Strip 3/5 – 4/5 in. (15 – 20 mm) insulation from each cable end.
3. Connect the positive battery cable (Red) to the positive mechanical lug (BAT+) and the negative battery cable (Black) to the negative mechanical lug (BAT-) using the torque values in the table above.
4. Verify the positive and negative battery cables are properly connected to the battery bank and the battery bank total amp hours meet or exceeds 400AH as specified in the table above.

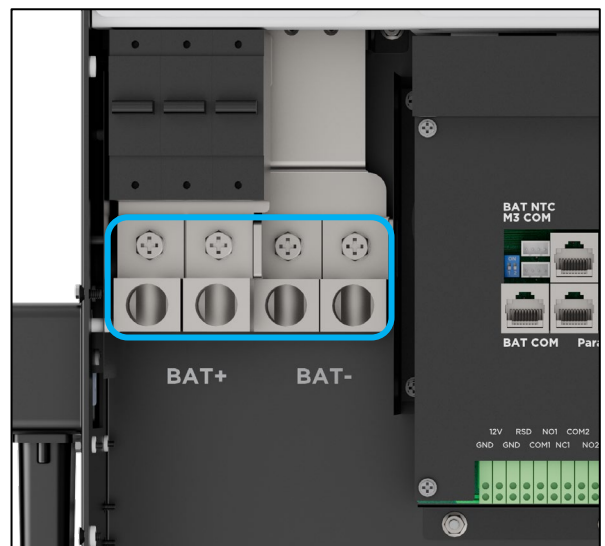



NOTE:

When installing multiple inverters in parallel and using the share battery feature, the battery or battery bank must be connected to each inverter so the current can be evenly shared to each inverter. The positive cable from the battery or battery bank to each inverter should be of equal length. If a busbar is used between the battery bank and the inverter, the cable from the busbar to each inverter should be equal lengths. Each negative cable should be of equal length as well. Using equal length positive cables and equal length negative cables supports equal amperage to each inverter.

5. Connect the included orange communications cable between inverter and battery communications port (either the CAN or RS485, depending on make/model of battery). See example diagram below:

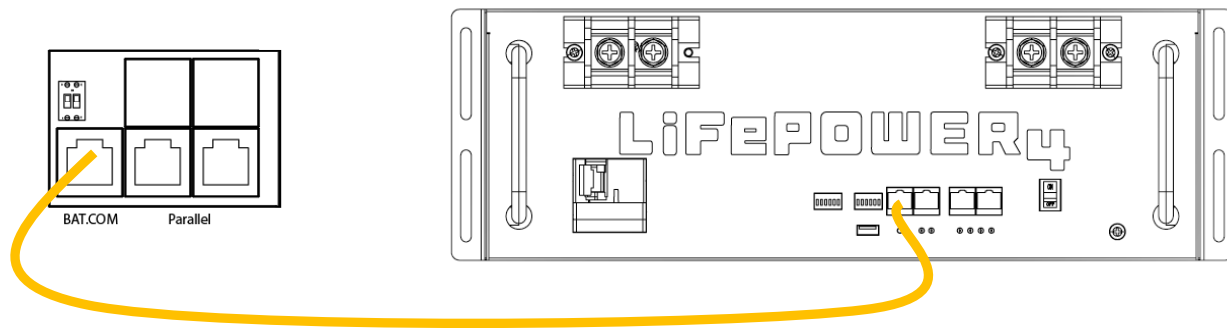

Multiple Inverters: If more than one inverter is installed, connect the battery communication cable to the inverter that will be used as the master inverter. All additional inverters will communicate with the master inverter through the parallel communication cable for all needed battery information.

Multiple Batteries: When using more than one battery, use the communication cable supplied with each battery to interconnect each battery, including the master battery. This allows the master battery to gather all battery data and provide it to the master inverter.



NOTE:

See battery product manuals at <https://eg4electronics.com/resources/downloads> for detailed information with configuring, connecting, and troubleshooting EG4® batteries.

8.3 AC CONNECTIONS

The inverter supports 100 amps of AC current on the Grid and EPS Load port. The loads (EPS) output can receive AC current directly from the AC input (bypass mode) or current inverted from PV and battery. There is also a smart load port that can be configured to either be a smart load output or an AC Coupled solar input. Smart loads can be programmed to either load shed, or power shed for individual appliances or whole subpanels. This smart port is either opened or closed based on the port configuration which is user defined.

It is recommended to install a separate AC breaker between inverter and AC input power source; this will ensure the inverter can be disconnected during maintenance and fully protected from over current AC input.



CAUTION:

- **Do not misconnect the grid input and loads output connections, which could cause damage to the inverter and attached devices.**
- **Be sure to connect AC wires with correct phasing. If L and N wires are connected in reverse, it may cause a utility short circuit when the inverters are working in parallel operation.**

INTEGRATED BREAKER	TERMINAL CONNECTION	MIN. WIRE SIZE	TORQUE VALUES
Mechanical Lug	GRID	3 AWG (27 mm ²)	97 – 106 in-lbs. (11 – 12Nm)
100A / 480VAC	LOAD	3 AWG (27 mm ²)	97 – 106 in-lbs. (11 – 12Nm)
63A / 480VAC	Smart Load	6 AWG (13 mm ²)	97 – 106 in-lbs. (11 – 12Nm)

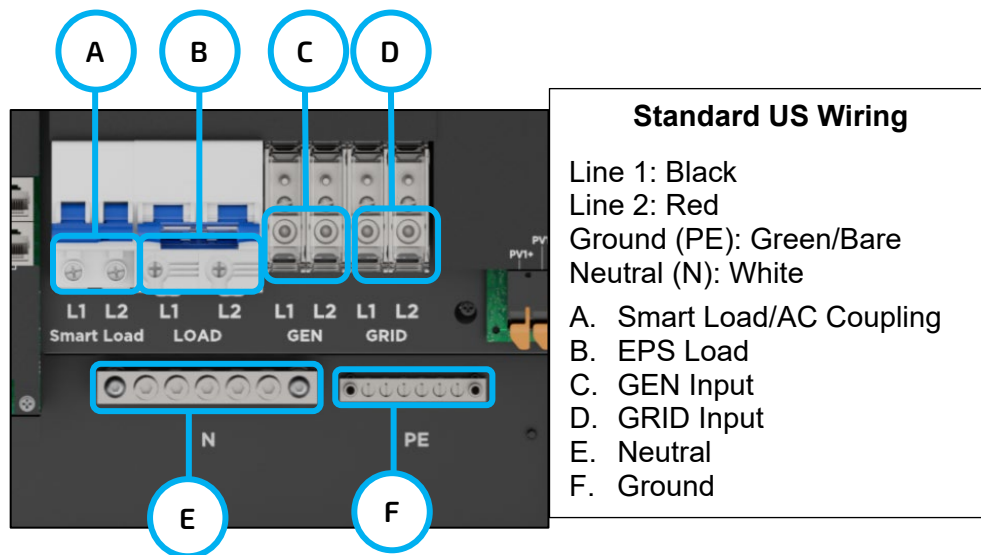

IMPORTANT:

Double check the neutral busbar for the inverter's internal neutral wire connection before making any connections. Do not install the neutral wire into the same lug as the inverter's neutral. This may disconnect the inverter's neutral from the bus and/or potentially create a double land scenario. This may lead to component damage.



NOTE:

- **Always be sure to connect the AC Output ground wire to the Ground terminal before installing the AC Outputs for L1 and L2.**
- **If using fine stranded wire, use ferrules to secure the connection.**
- **When installing multiple inverters in parallel, it is recommended to use equal length AC cables from each inverter to the main panel and from each inverter to the loads panel. This helps ensure that while in pass through mode, the load sharing between each inverter is as even as possible.**

Cable Installation

1. Before making any connections, ensure all breakers are open (OFF). Use a multimeter to confirm the AC input lines (L1, L2 and neutral) are not carrying current from the main panel. Verify the DC input lines are not carrying current. Verify the PV input lines are not carrying current.
2. Strip off 5/16 – 3/8 in. (8 – 10 mm) insulation from the AC cables.
3. Fasten the AC input wires into their respective mechanical lugs using the proper torque ratings shown in the table above. Fasten the neutral wire into the neutral bus (labeled N in the inverter).
4. Always be sure to connect the AC Output ground wire to the Ground terminal bus (labeled PE in the inverter) before installing AC Outputs L1 and L2.

8.4 NEUTRAL-GROUND BONDING

The information below describes the nature of the neutral and ground in the inverter and their relationship to the system. Always consult with the installer or a licensed electrician to ensure that the right configuration is being used:

- The neutral line is a solid connection between AC input and AC output (known as a Common Neutral Architecture).
- The neutral line between the AC input and AC output is never disconnected.
- This architecture assumes there is a single neutral-ground bond in the system. The system should have only one neutral-ground bond (this is typically the Main Bonding Jumper located at the first grid system disconnect. However, if there is no neutral-ground bond in the system, the 12000XP can be configured to create the bond internally (see *N-PE Connect setting, page 41*).



WARNING:

The 12000XP does not have the functionality to support a dynamic bond. The bond is either always enabled or always disabled.

8.5 GENERATOR CONNECTIONS

The EG4® 12000XP inverter has the ability to utilize a generator in two different ways. The first option is more traditional where the generator must be sized larger than the inverter output. In this case, a 15kW generator is recommended for backup power in the case of grid failure. The second option is to use a smaller generator in combination with batteries to provide power for the loads. This feature is called Gen Boost. See the LCD Settings Menu and Monitor Center Setting sections for more information on proper setting configuration.

When attaching generators directly to the generator port, the Total Harmonic Distortion (THD) of the generator must be <3%. To achieve this optimal THD value, it is recommended to size the generator for **at least** 1.5x the output of the inverter to allow for powering loads and charging batteries. The table below shows the recommended generator capacity for optimal operations. There is no need to size the generator larger than the loads when using the Gen Boost feature.



CAUTION:

Generators with >3% THD may not be compatible with the 12000XP.

NUMBER OF INVERTERS IN PARALLEL	RECOMMENDED GENERATOR CAPACITY
1	6kW – 15kW
2	12kW – 30kW

TERMINAL CONNECTION	MIN. WIRE SIZE	TORQUE VALUES
Generator	4 AWG (21 mm ²)	97 – 106 in-lbs. (11 – 12Nm)

Cable Installation:

1. Before making any wiring connections, be sure to have the inverter(s) powered off, the generator powered off, and all circuit breakers open (OFF) to prevent damage to the unit.
2. Properly identify the generator's output lines. By US wiring standards, L1 wire will be black, L2 will be red, neutral will be white, and ground will be green or bare. Once identified, remove 5/16 – 3/8 in. (8 – 10 mm) insulation from the wires.
3. Ground the generator's output ground to the ground bus (labelled PE) in the inverter.
4. Install L1 to the GEN port's L1 terminal, then install L2 to the GEN port's L2 terminal. Next, fasten the neutral wire from the generator into the N-BUS (Neutral Bus).

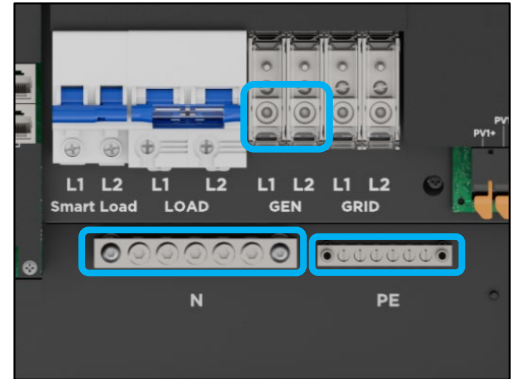

NOTE:

When connecting multiple inverters in parallel, the generator must connect to each inverter. Connecting to a single inverter in a multiple inverter configuration is not supported.



IMPORTANT:

Double check the neutral busbar for the inverter's internal neutral wire connection before making any connections. Do not install the neutral wire into the same lug as the inverter's neutral. This may disconnect the inverter's neutral from the bus and/or potentially create a double land scenario. This may lead to component damage.

Generator Auto-Start

When properly wired and configured, the generator will start automatically when the battery voltage is lower than the cut-off value or there is a charge request from the BMS. When the generator is running, it will charge the batteries and excess AC power will be diverted to the AC output (LOAD) to power loads. The pass-through relay on the inverter's generator terminal (GEN) is 90A. When the generator is on, ensure the total load and charge current does not exceed 90A. If the generator's power is not adequate to power all loads, the inverter will pull from batteries as supplemental power. When the battery voltage exceeds the threshold for AC charging, the generator will stop.

The dry port (NO2 and COM2) ports can deliver a signal to an external device when battery voltage/SOC reach the warning levels. The GEN port (NO1, COM1) is used to wake up the generator and then the generator can charge the battery.

UNIT STATUS	CONDITION		DRY PORT COM2 & NO2	GEN NO1 & COM1
Power Off	The inverter is off with no power output		Open	Open
Power On	Without Grid	Battery voltage/SOC < Generator Charge Start Voltage/SOC	Close	Close
		Battery voltage/SOC > Generator Charge End Voltage/SOC	Open	Open
Power On	With Grid	Battery voltage/SOC < Generator Charge Start Voltage/SOC	Close	Open
		Battery voltage/SOC > Generator Charge End Voltage/SOC	Open	Open

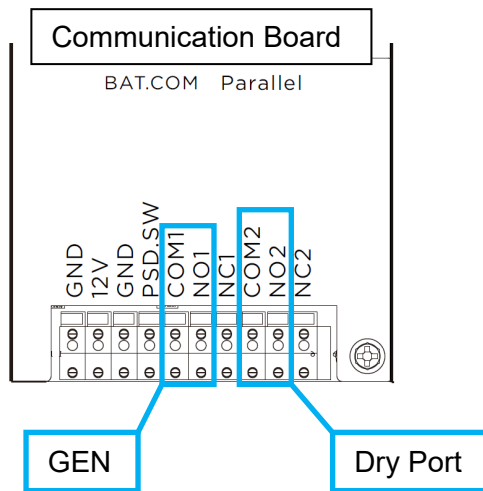

Dry Port Relay Maximum Specification: 250VAC 5A
Gen Port Relay Maximum Specification: 250VAC 5A
NO---Normal Open

Generator Start and Stop Settings

Using the LCD screen on the inverter, press the “Enter” button to wake up the display. When the display is activated, the display will show the home screen. Select “Enter” again to access the main menu, from there press the “Setting” button. Navigate to page 3 of the “Charge” tab for generator settings (*shown in the image below*). For more information navigating the LCD menu, see section 12.4, and for further information on the generator settings, see section 12.7.

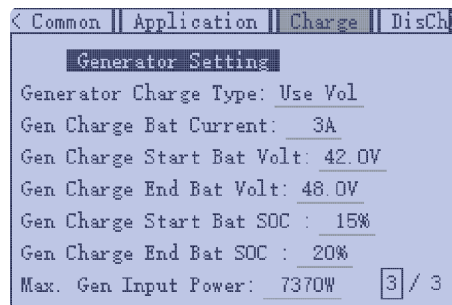

Using the EG4® Monitor Center, go to the “Maintenance” tab where “Remote Set” will be selected by default. Scroll to the “Generator Charge” section and select the “Generator Charge Type.” Normally, lead-acid batteries are charged according to voltage and lithium batteries are charged according to SOC. For more information on the EG4 Monitor Center and generator settings, see section 14.

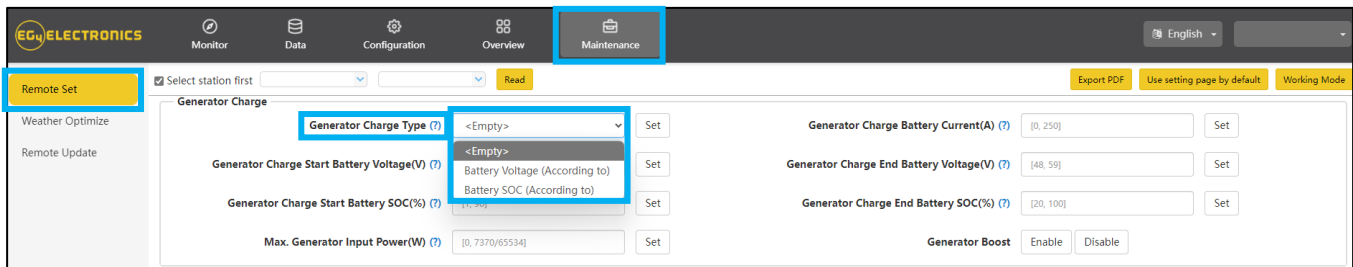

Generator Start Conditions:

The generator will start when the utility fails **and** the following condition is met:

- The battery voltage or SOC is lower than the “Generator Charge Start Battery Voltage(V) or SOC(%)”.

Generator Stop Conditions:

When battery voltage or SOC is higher than the “Generator Charge End Battery Voltage(V)/SOC(%)” settings.

8.6 OFF-GRID

The EG4® 12000XP inverter can fully function in off-grid mode. It does not need the utility or generator to function. Purely off-grid systems that do not have access to the utility should strongly consider having a 2-wire start backup generator for extended cloudy periods (6kW – 15kW per 12000XP). Off-grid systems should have adequately sized battery banks to ensure multiple days of power and to reduce generator run time.

The 12000XP can accept up to 63A (6kW – 15kW) of generator power and will pass through all available power to the loads. Therefore, the loads subpanel can be sized up to the size of the backup generator with 63A minimum per inverter.

9. FIRST TIME POWER UP

This section describes powering on a single or multiple inverters for the first time, including the related configurable settings on the LCD screen. These settings can also be configured using the mobile app or Monitor Center website after a user account is created. Follow the steps in section 13.2 to create a new user account and then section 13 for using Monitor Center.



WARNING:

If more than one inverter is installed and interconnected as one energy storage system, follow section 8.2. Each inverter must be properly configured to work together in parallel mode before outputting current on the load ports. If the proper configuration is not followed, damage could be caused to the inverter and the connected devices.

9.1 SINGLE INVERTER

1. Ensure each inverter circuit breaker is in the open (OFF) position. No voltage should be coming in or out of the inverter at this point.
2. Using a multimeter, check the following:
 - a. Check the battery bank voltage is within operating range at the inverter DC breaker, or the external DC disconnect.
 - b. Check the PV voltage is within operating range at input connections of the inverter.
 - c. If using AC input, double check each hot line to neutral connection supplying power to the inverter to ensure voltage is in operating range of the inverter.
3. Upon confirming all voltages are within the inverter's operating range, set the inverter battery breaker to the closed (ON) position. If equipped, close the external battery breaker installed between battery bank and inverter.
4. Power on each battery one at a time, starting with the master, then each additional battery in ≈ 5 second intervals.
5. Power on the inverter using the power switch on the lower right side of the unit.
6. Check for warnings and errors on the upper right corner on the front display panel. If the inverter shows "Normal" move ahead to the next step.

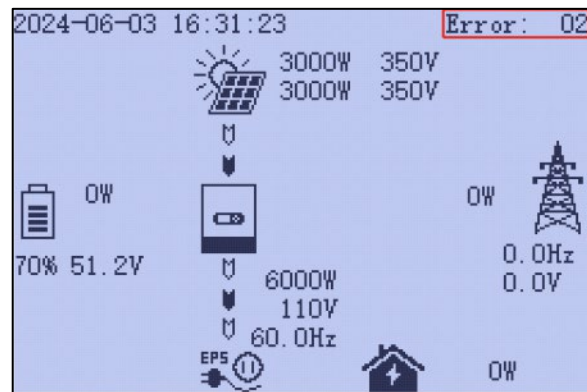
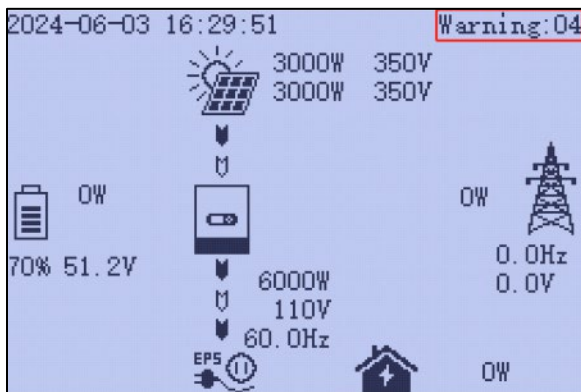

7. Move the external PV isolator switch to the closed (ON) position. Set the PV switch on the side of the inverter to the closed (ON) position. Again, check for errors or warnings on the front display panel. If the inverter shows "Normal" go ahead to the next step.
8. If using grid input, set the external breaker between input panel and inverter to the closed (ON) position. Next, move the inverter GRID breaker to the closed (ON) position. This should provide AC power to the inverter. Again, check for errors or warnings. If the inverter shows "Normal" proceed to the next step.
9. As best practice, configure the following settings using the inverter display panel (*see section 12 for more information on using the display panel*).

- **Common Tab (Pages 1 and 2)**

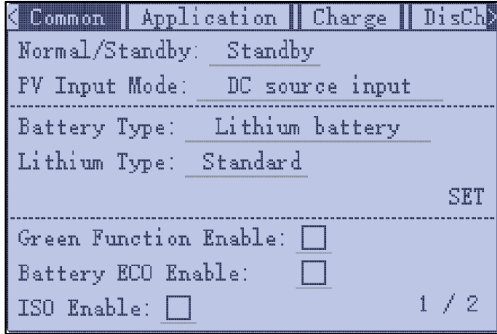

PV Input Mode: select one of the following:

- DC source input (caps the MPPT at 120V during startup)
- PV1 and PV2 independent
- PV1 and PV2 parallel

Battery Type: select No battery, Lead Acid or Lithium

Lithium Type: select a supported brand of battery (Select “1” if using an EG4® lithium battery.)



NOTE:

For communication with EG4 batteries ensure the battery firmware is up to date, by contacting the distributor for this file or navigate to <https://www.eg4electronics.com> for the most recent updates and documentation. After ensuring the firmware is up to date, select “Lithium” under “Battery Type” and then select “1” under “Lithium Type”.

- *If using LifePower4 V1 batteries or RS485 communications, use “0:EG4” under “Lithium Type”.*

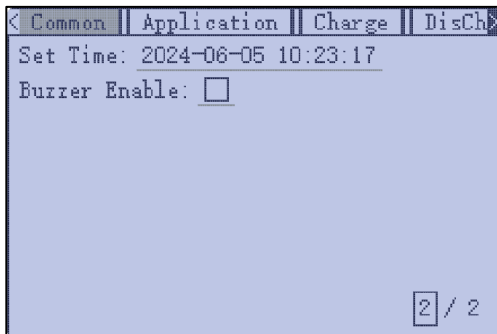

Set Time: Set or verify the current date and time.

Buzzer Enable: Remove the check mark to disable the beep when the display buttons are pressed.

- **Application Tab (Page 1)**

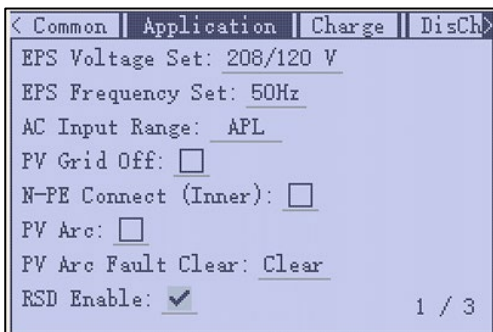

EPS Voltage Set: Verify the voltage is set to 240Vac

EPS Frequency Set: Verify frequency is set to 60Hz

AC Input Range: Choose APL or UPS. UPS: supports AC voltage range 170V – 280V and APL supports voltage range from 90V – 280V. UPS will have a faster switchover time.

N-PE Connect: Normally unchecked when using AC input from the grid. If there is not grid input, verify where the neutral ground bond is setup. Consult with a qualified electrician for help if needed.

10. Verify the loads panel is ready to accept current from the inverter. Set the input breaker at the loads panel to the closed (ON) position.
11. Set the output breaker on inverter to the closed (ON) position. Turn the EPS output switch to the closed (ON) position. The inverter should now be providing current to the loads panel.

9.2 MULTIPLE INVERTERS

The EG4® 12000XP Off-Grid inverter supports up to 16 units connected in parallel to reach a capacity of up to 192kW. To successfully connect inverters together in a parallel configuration, verify the following:

- A single string of solar panels cannot be shared between inverters.
- Each inverter must be cabled to the same single battery or battery bank.
- To support proper ventilation and cooling, ensure the inverters are installed with required clearances as shown in section 7.2.



CAUTION:

Only use the provided grey parallel cable when connecting the inverters together. Using the wrong cable could cause hardware damage. If a longer cable is required, see below for more information on creating a cable or contact the distributor.

1. Set the CAN communication PIN to ON position for the first and the last inverter. Set the PIN to the OFF position for any inverters between the first and last. Both switches in the “ON” position translates to address 1. Both switches in the “OFF” position translates to address 0.
2. Install the included parallel cable (grey in color) to the parallel port on each inverter as shown in the diagram below. If only two inverters are installed only one parallel cable is required. Two parallel cables will provide redundancy in the event one cable is disconnected or stops working.

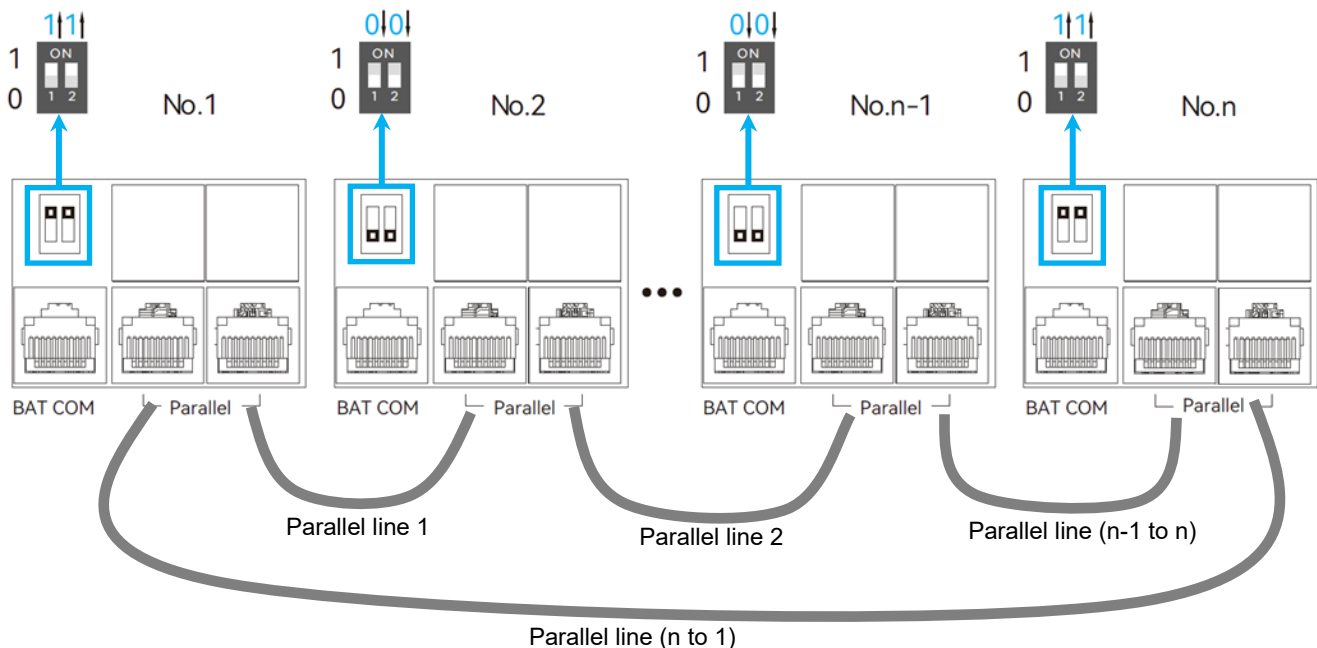

3. Ensure each inverter circuit breaker is in the open (OFF) position. No voltage should be coming in or out of the inverter at this point.

4. Using a multimeter, check the following:
 - a. Check the battery bank voltage is within operating range at the inverter DC breaker, or the external DC disconnect.
 - b. Check the PV voltage is within operating range at input connections of the DC isolation switch.
 - c. If utilizing AC input, double check each hot line to neutral connection supplying power to the inverter to ensure voltage is in operating range of the unit.
5. Upon confirming all voltages are within the inverter’s operating range, set the inverter battery breaker to the closed (ON) position. If equipped, set the external battery breaker installed between the battery bank and inverter to the closed (ON) position
6. Begin powering on each battery one at a time, starting with the master. Then power on each additional battery in ≈5 second intervals.
7. Move the external PV isolator switch to the closed (ON) position (if equipped). Set the PV switch on the side of the inverter to the closed (ON) position.
8. If using AC input, set the external breaker between input panel and inverter to the closed (ON) position. Next, set the inverter GRID breaker to the closed (ON) position.
9. Power on the master inverter (the inverter communicating with the battery bank) using the inverter power switch.
10. Configure the following settings using the inverter display panel (see section 12 for more information on using the display panel).

• **Common Tab (Pages 1 and 2)**

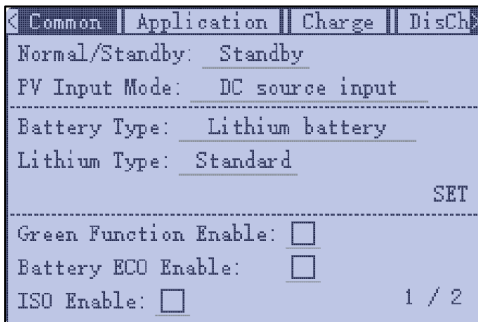

PV Input Mode: Select one of the following:

- DC source input (caps the MPPT at 120V during startup)
- PV1 and PV2 independent
- PV1 and PV2 parallel

Battery Type: Select No battery, Lead Acid or Lithium.

Lithium Type: Select a supported brand of battery. (Select “0:EG4” if using an EG4® lithium battery)



NOTE:

For communication with EG4 batteries ensure the battery firmware is up to date, by contacting the distributor for this file or navigate to <https://www.eg4electronics.com> for the most recent updates and documentation. After ensuring the firmware is up to date, select “Lithium” under “Battery Type” and then select “1” under “Lithium Type”.

- **If using LifePower4 V1 batteries or RS485 communications, use “0:EG4” under “Lithium Type”.**

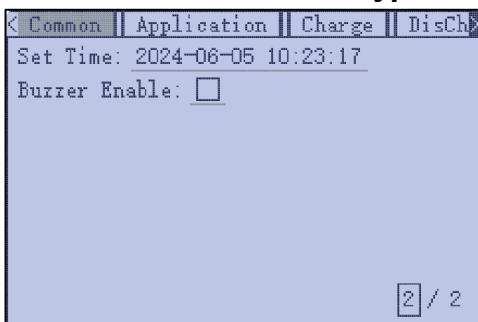

Set Time: Set the current date and time.

Buzzer Enable: Remove the check mark to disable the beep when the display buttons are pressed.

- **Application Tab (Pages 1 and 3)**

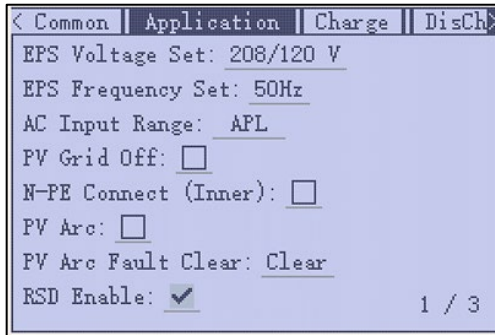

EPS Voltage Set: Verify the voltage is set to 240VAC.

EPS Frequency Set: Verify frequency is set to 60Hz.

AC Input Range: Choose APL or UPS. UPS: supports AC voltage range 170V – 280V and APL supports voltage range from 90V – 280V. UPS will have a faster switchover time.

N-PE Connect: Normally unchecked when using AC input from the grid. If there is not grid input, verify where the neutral ground bond is setup. Consult with a qualified electrician for help if needed.

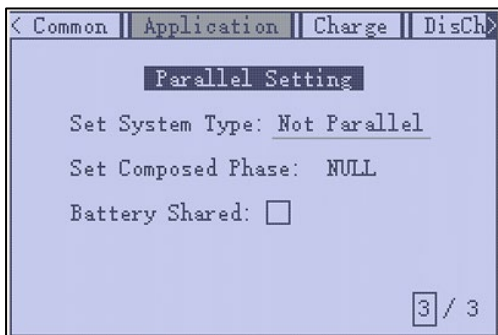

Set System Type: Change from Not Parallel to Parallel.

Battery Shared: Place a check mark in the battery shared box.

Note: Repeat the “Set System Type” and “Battery Shared” settings on each inverter connected in a parallel configuration. The rest of the settings will be copied to each inverter as they are set on the master inverter.

- **Discharge**

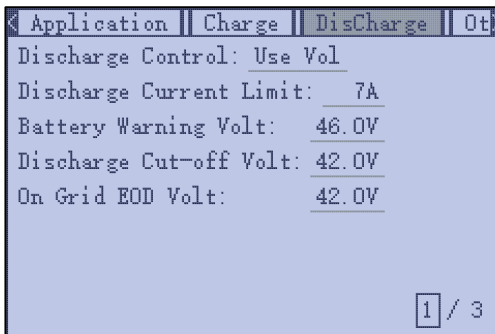

Discharge Current Limit: The discharge current limit is at 250A to support a single inverter. When running in parallel mode, set the max discharge to support the max current draw as a total from all connected inverters. If this setting is not adjusted and the inverter uses current greater than the default setting, the inverter will either shutdown or switchover to grid supplying the loads. Once the load returns to within specified settings, the inverter will switchover back to battery.

11. Power off all inverters. Then power on the master. Once the master inverter is powered up, power on each additional inverter.
12. After all the inverters are powered up, double check each inverter and verify the system type is set to “Parallel” and the battery shared option is selected.
13. Ensure the battery communications cable is properly connected from master battery to the master inverter.

- Using the inverter display panel, verify there are no faults or alarms (see section 12 for more information).

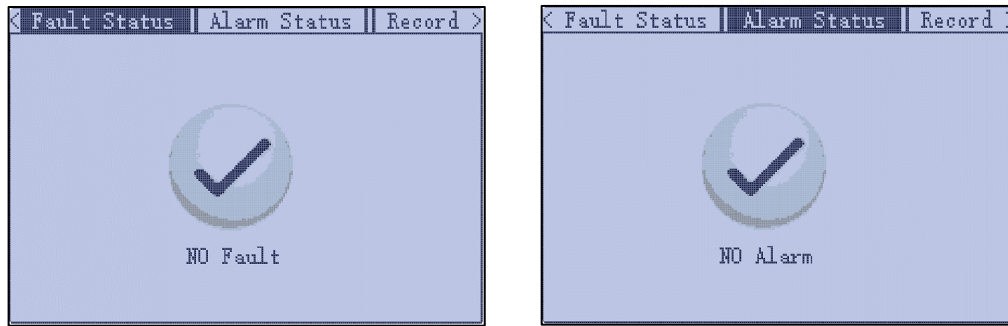

- Verify the loads panel is ready to accept current from the inverter. Set the input breaker at the loads panel to the closed (ON) position.
- Set the output breaker on inverter to the closed (ON) position. Turn the EPS output switch to the closed (ON) position. The inverter should now be providing current to the loads panel.

10. RAPID SHUTDOWN/ESS DISCONNECT

The inverter supports a rapid shutdown system that complies with 2017 and 2020 NEC 690.12 requirements. A rapid shutdown switch should be connected to the RSD terminals on the master inverter and mounted in a readily accessible location outdoors (check with the local AHJ for specific requirements). For paralleled systems, the RSD needs only to connect to the master inverter. When the switch is engaged, it will shut down all inverters in parallel past the master.



NOTE:

When using supported EG4® batteries in closed loop communications with the inverter, the RSD also initiates ESS Disconnect.

10.1 EXTERNAL RSD

The system can also utilize an External E-Stop Switch if the local AHJ deems it necessary.

- The external switch must be “Normally Open” by default, and “Closed” when the button is pressed for emergency shutdown.
- The external switch should be connected to the RSD terminals on the inverter and mounted in a readily accessible location outdoors (check with the local AHJ for requirements).
- Wire the E-Stop Switch into the RSD terminals according to the switch’s specifications.

External RSD Wiring

The image below showcases an example diagram using a Tigo RSD Transmitter (not included). Wire the E-Stop Switch into the RSD terminals on the master inverter, as shown below, following the specific switch’s specifications. Please refer to the switch’s manual for exact specifications and wiring instructions.

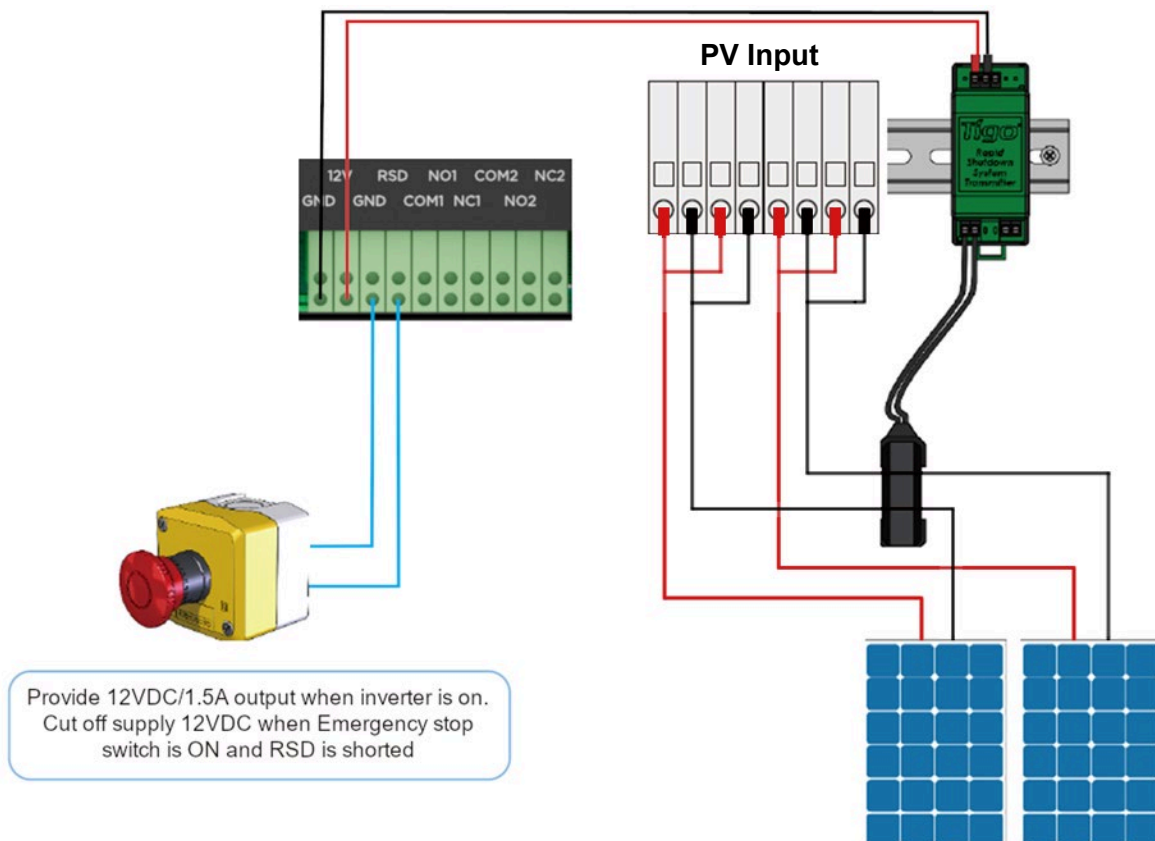

11. SMART PORT

The smart load port in the 12000XP is a programmable smart port that can either output to loads or be enabled to accept an AC coupled system as input. The settings to configure either Smart Load or AC Coupling is found in the discharge settings section on the LCD screen (shown in section 12.7), the EG4® Monitor Center (shown in section 14.4), or the EG4 Monitor App.

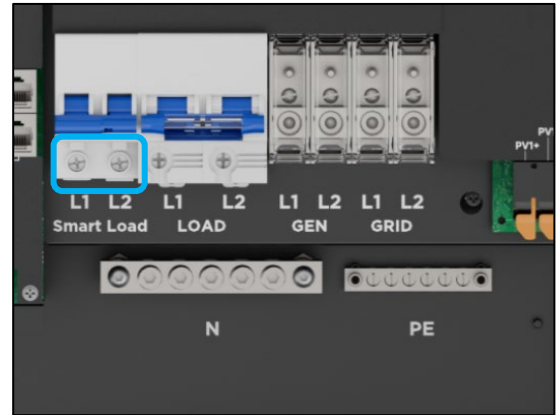

11.1 SMART LOAD

The smart load port enhances the efficiency and effectiveness of solar power systems by intelligently managing energy consumption. The smart port uses sensors, controllers, and communication technologies to adjust output in real-time. The port can be programmed to either load shed, or power shed for individual smart appliances or whole subpanels. If enabled, the inverter will supply power to the load when the battery SOC and PV power are above the user set values.

After Smart Load Enabled:

When PV power exceeds the set start PV power, and the battery SOC/voltage gets to the start SOC/voltage, the smart load port will automatically switch on to power the connected load. When the battery reaches the end SOC/voltage or PV drops below the start PV power value, the smart load port automatically switches off.

Smart Load Settings:

The “Smart Load” setting must be enabled when the end user is trying to use the configurable settings to control the smart port’s output. The inverter will provide power to this load based on set “Smart Load Start Volt/SOC”, “Smart Load End Volt/SOC” and “Start PV power” values (see section 12.7 for settings through the LCD, see section 14.4 for settings through the Monitor Center).



WARNING:

If the Smart Load function is enabled, an AC coupled system CANNOT be connected at the same time; otherwise, the device will be damaged.

11.2 AC COUPLING

The smart load port allows the user to AC couple, by adding onto an existing grid tied solar system. PV comes from the existing system while the AC coupled inverter controls battery charging and any extra PV coming into the system. This setting allows the user to still have power off-grid. The inverter can accept PV inputs to both MPPT channels and AC coupled solar input simultaneously. The AC coupled solar input can be up to 62.5A of AC power while the MPPT channels can handle up to 24kW of solar. Off-grid inverters such as the 12000XP are capable of AC coupling, but not of selling back energy to the grid. To enable AC coupling or configure AC coupling settings, ensure the inverter is in standby mode.

After AC Couple Enabled:

When battery SOC or voltage gets below the set parameters, AC coupling will engage and use PV from the existing solar system to charge the batteries. When the battery bank is charged to the set limit, the inverter will continue to control the loads without charging the battery bank. There will be about a 5-minute delay for AC coupling to turn on.

AC Coupling Settings:

The “AC Couple” setting must be enabled when connecting an existing on-grid system to the smart load port. It is recommended to keep the “Start SOC(%) / Voltage(V)” and the “End SOC(%) / Voltage(V)” within 5 – 10% of each other for optimal operations when utilizing AC coupling (see section 12.7 for settings through the LCD, see section 14.4 for settings through Monitor Center).

12. FRONT PANEL DISPLAY

The user can wake up the LCD screen by simply pressing the Enter button. System status, real-time power, and daily and accumulated energy information can all be conveniently viewed on the inverter’s LCD screen. Additionally, users can check the alarm and fault record on the display for troubleshooting.

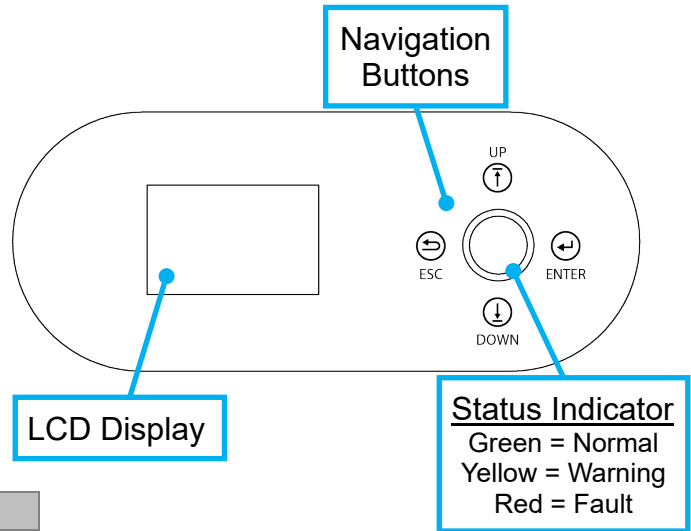

12.1 DISPLAY OVERVIEW

NO.	DESCRIPTION	COMMENTS
1	General Information Display Area	Displays the current time/date by default.
2	Photovoltaic (PV) Data	Displays the current PV data.
3	Working status text display area	This area displays the status code of the inverter, including rated running status text, errors codes, and alarms codes.
4	Battery information and data	This area displays the battery type, (lithium or lead acid), voltage, SOC, and input/output power.
5	UPS/EPS output information and data	This area displays LOAD voltage, frequency, power.
6	Grid and Generator information	Displays the grid information for voltage, frequency, input or output power, the Generator information of voltage, frequency, input power.
7	Load consumption	Displays the power consumption by the load in the On-grid Mode.

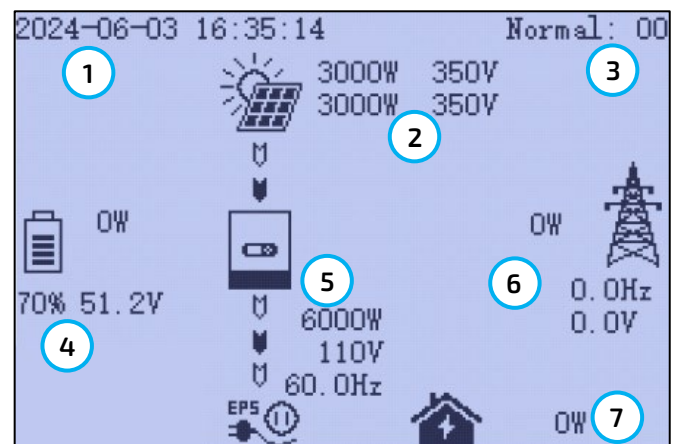

12.2 INVERTER STATUS



The information in the table below demonstrates the various status codes that can be displayed on the LCD panel.

<p>Normal/Running Status:</p>	<p>Warning Status:</p>
<p>Fault Status:</p>	<p>Flash Status:</p>
<p>Utility Grid Status:</p>	<p>Generator Grid Status:</p>

12.3 WORKING MODES

The table below describes how the inverter's LCD will display different modes of operation at a given scenario. The inverter logic will automatically operate in one of the modes listed in the table below without any required configuration. However, there are working mode settings that can be configured within Monitor Center to control when a particular working mode is used.

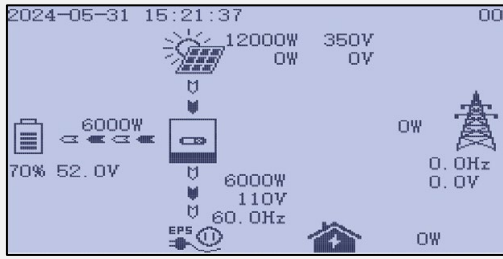
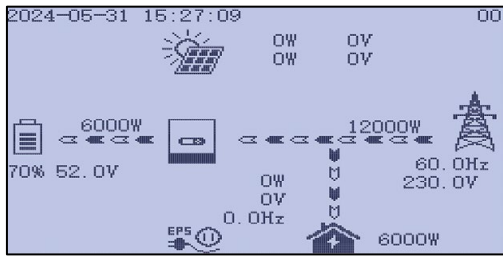
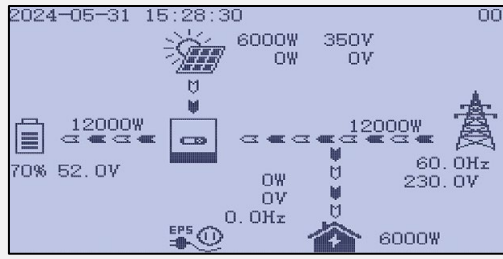
MODE	DIAGRAM	COMMENTS
Bypass Mode	<p>The LCD display shows the date and time as 2024-05-31 15:05:43. It features a sun icon for PV (0W, 0V) and a power line icon for AC (0W, 0V). A battery icon shows 0% charge (0.0V). A house icon at the bottom indicates 12000W power to the load. An AC tower icon shows 12000W power from the grid at 60.0Hz and 230.0V. An EPS icon is also present.</p>	AC powers the load
PV Charge Bypass	<p>The LCD display shows the date and time as 2024-05-31 15:06:37. It features a sun icon for PV (12000W, 350V) and a power line icon for AC (0W, 0V). A battery icon shows 70% charge (52.0V). A house icon at the bottom indicates 12000W power to the load. An AC tower icon shows 12000W power from the grid at 60.0Hz and 230.0V. An EPS icon is also present.</p>	PV charges the battery while AC powers the load
BAT Off-Grid	<p>The LCD display shows the date and time as 2024-05-31 15:15:48. It features a sun icon for PV (0W, 0V) and a power line icon for AC (0W, 0V). A battery icon shows 70% charge (52.0V) with 6000W being discharged. A house icon at the bottom indicates 6000W power to the load. An AC tower icon shows 0.0Hz and 0.0V. An EPS icon is also present.</p>	Battery powers the load
PV+BAT Off-Grid	<p>The LCD display shows the date and time as 2024-05-31 15:18:30. It features a sun icon for PV (3000W, 350V) and a power line icon for AC (0W, 0V). A battery icon shows 70% charge (52.0V) with 3000W being discharged. A house icon at the bottom indicates 6000W power to the load. An AC tower icon shows 0.0Hz and 0.0V. An EPS icon is also present.</p>	PV & Battery power the load
PV Charge	<p>The LCD display shows the date and time as 2024-05-31 15:20:37. It features a sun icon for PV (12000W, 350V) and a power line icon for AC (0W, 0V). A battery icon shows 70% charge (52.0V) with 12000W being charged. A house icon at the bottom indicates 0W power to the load. An AC tower icon shows 0.0Hz and 0.0V. An EPS icon is also present.</p>	<ol style="list-style-type: none"> 1. With EPS output switch off, the inverter charges the battery only 2. With battery power off, PV can wake up the battery automatically

<p>PV Charge+Off-Grid</p>		<p>PV charges the battery and powers the load</p>
<p>AC Charge</p>		<ol style="list-style-type: none"> 1. AC powers the battery from AC Input (Grid) or Generator Input (GEN) 2. When batteries reach low threshold, charge bank with Grid/GEN
<p>PV+AC Charge</p>		<p>PV & AC charge the battery. AC is from AC Input (Grid) or Generator Input (GEN)</p>
<p>PV Off-Grid</p>		<p>When setting without battery, the PV can power the load.</p> <p>NOTE: The output power depends on the PV energy input, if the PV energy is unstable, the output power will be unstable.</p>

12.4 LCD MENU NAVIGATION

There are four buttons on the front panel LCD screen used for navigation and setting changes.

BUTTON	FUNCTION
Return	Exit
Enter	Confirm, Enter Menu
UP	Previous Level, Increase
Down	Next Level, Decrease

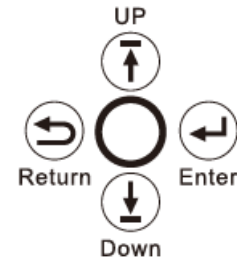

Pressing **Enter** on the home screen provides access to the main menu:

- Home
- Data
- Notice
- Setting

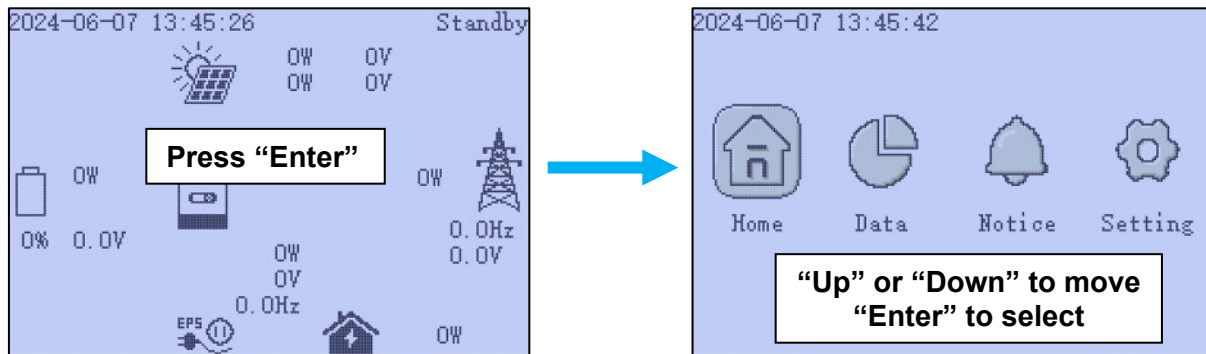

Press the "Down" arrow to move right, then press "Enter" to select. Once an item from the main menu is selected, use the following for navigation:

Moving between Tabs

- "Up" button to move right.
- "Down" button to move left.

Moving between pages within the tab

- "Enter" selects the page number area.
- "Down" moves to the next page.
- "Up" moves to the previous page.
- "Esc" exits the page selection.
- "Up" to previous tab or "Down" to next tab.
- "Esc" again goes back to the main menu.

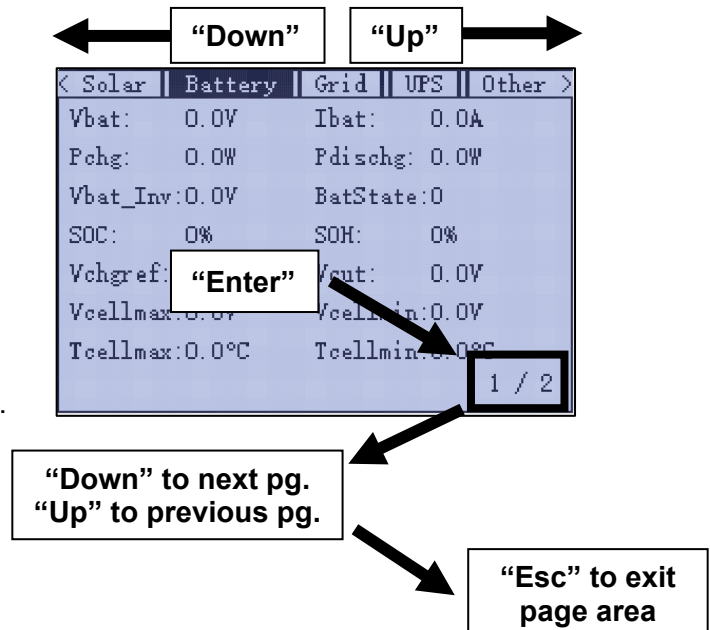

12.5 DATA MENU

Solar Tab

Vpv1: MPPT1 voltage
Vpv2: MPPT2 voltage
Ppv1: MPPT1 power
Ppv2: MPPT2 power
Epv1_day: MPPT1 power generation in one day
Epv2_day: MPPT2 power generation in one day
Epv1_all: MPPT1 total power generation
Epv2_all: MPPT2 total power generation

Solar		Battery		Grid		UPS		Other	
Vpv1:	0.0V	Ppv1:	0.0W						
Vpv2:	0.0V	Ppv2:	0.0W						
Epv1_day:	23.5kWh	Epv1_all:	34.5MWh						
Epv2_day:	64.3kWh	Epv2_all:	855.6kWh						

Battery Tab

(Page 1 / 2)

Vbat: Battery voltage
Ibat: Battery charge and discharge current
Pchg: Battery charge power
Pdischg: Battery discharge power
Vbat_Inv: Inverter sampling battery voltage
BatState: Battery state
SOC: Battery remaining power
SOH: Battery health
Vchgrf: Battery charge cut-off voltage
Vcut: Battery discharge cut-off voltage
Vcellmax: Highest cell voltage
Vcellmin: Lowest cell voltage
Tcellmax: Highest cell temperature
Tcellmin: Lowest cell temperature

Solar		Battery		Grid		UPS		Other	
Vbat:	0.0V	Ibat:	0.0A						
Pchg:	0.0W	Pdischg:	0.0W						
Vbat_Inv:	0.0V	BatState:	0						
SOC:	0%	SOH:	0%						
Vchgrf:	0.0V	Vcut:	0.0V						
Vcellmax:	0.0V	Vcellmin:	0.0V						
Tcellmax:	0.0°C	Tcellmin:	0.0°C						

1 / 2

(Page 2 / 2)

CycleCnt: Number of charge and discharge cycles of the battery
BatCapacity: Capacity of the battery
Imaxchg: Maximum charge current
Imaxdischg: Maximum discharge current
BMSEvent1: BMS event 1
BMSEvent2: BMS event 2
Echg_day: Charge power in a day
Edischg_day: Discharge power in a day
Echg_all: Total charge
Edischg_all: Total discharge power

Solar		Battery		Grid		UPS		Other	
CycleCnt:	0								
BatCapacity:	0.0Ah								
Imaxchg:	0.0A								
Imaxdischg:	0.0A								
BMSEvent1:	0								
BMSEvent2:	0								
Echg_day:	254.3kWh								
Edischg_day:	2453.7kWh								
Echg_all:	58.2kWh								
Edischg_all:	89.7MWh								

2 / 2

Grid Tab

(Page 1 / 2)

Vgrid: Grid voltage

Fgrid: Grid frequency

VgridL1N: Split phase L1-N voltage

VgridL2N: Split phase L2-N voltage

Vgen: Generator voltage

Fgen: Generator frequency

Pimport: Power input from the grid to the inverter

Pexport: Power output from the inverter to the grid. The output should be 0kWh since this is an off-grid inverter.

Pinv: Inverted power

Prec: Rectified power

Pload: Load power

< Solar	Battery	Grid	UPS	Other >
Vgrid:	0.0V	Fgrid:	0.0Hz	
VgridL1N:	0.0V	VgridL2N:	0.0V	
Vgen:	0.0V	Fgen:	0.0Hz	
Pimport:	0.0W	Pexport:	0.0W	
Pinv:	0.0W	Prec:	0.0W	
Pload:	0.0W			1 / 2

(Page 2 / 2)

Eexport_day: Power the inverter has exported to the grid during the day. The output should be 0kWh since this is an off-grid inverter.

Eexport_all: Total power the inverter has exported to the grid. The output should be 0kWh since this is an off-grid inverter.

Eimport_day: Power imported from the grid to the inverter during the day

Eimport_all: Total power imported from the grid to the inverter

Einv_day: Amount of inverted power in a day

Erec_day: Amount of rectified power in a day

< Solar	Battery	Grid	UPS	Other >
Eexport_day:		0kWh		
Eexport_all:		0kWh		
Eimport_day:		0kWh		
Eimport_all:		0kWh		
Einv_day:	0kWh	Einv_all:	0kWh	
Erec_day:	0kWh	Erec_all:	0kWh	
				2 / 2

UPS Tab

(Page 1 / 2)

Veps: Load voltage

Feps: Load frequency

VepsL1N: L1-N voltage of load

VepsL2N: L2-N voltage of load

Peps: The active power of load

Seps: The apparent power of load

PepsL1N: L1-N active power of load

SepsL1N: L1-N apparent power of load

PepsL2N: L2-N active power of load

SepsL2N: L2-N apparent power of load

< Solar	Battery	Grid	UPS	Other >
Veps:	0.0V	Feps:	0.0Hz	
VepsL1N:	0.0V	VepsL2N:	0.0V	
Peps:	0.0W	Seps:	0.0VA	
PepsL1N:	0.0W	SepsL1N:	0.0VA	
PepsL2N:	0.0W	SepsL2N:	0.0VA	
				1 / 2

(Page 2 / 2)

Eeps_day: Daily load (L1-L2) power output

Eeps_all: Total load (L1-L2) power output

EepsL1N_day: Load (L1-N) output power in a day

EepsL1N_all: Total power output of load (L1-N)

EepsL2N_day: Load (L2-N) output power in a day

EepsL2N_all: The total power output of load (L1-N)

< Solar	Battery	Grid	UPS	Other >
Eeps_day:	24.3kWh			
Eeps_all:	8753.5kWh			
EepsL1N_day:	5.4kWh			
EepsL1N_all:	3574.0kWh			
EepsL2N_day:	15.6kWh			
EepsL2N_all:	5676.3kWh			

2 / 2

Parallel Tab

Parallel Role: Role of the inverter in the parallel state (master and slave)

Parallel Type: Type of parallel connection, single phase or three phase

Parallel Phase: Parallel phase (U, V, or W) for three phase configurations

Parallel Num: Number of parallel inverters

Parallel Addr: Inverter parallel address

< Battery	Grid	UPS	Parallel	Oth >
Parallel Role:	Master			
Parallel Type:	Single phase			
Parallel Phase:	U phase			
Parallel Num:	0			
Parallel Addr:	0			

Other Tab

Status: Current status of the inverter

NextStatus: Next status of the inverter

FaultCode: Inverter error code

AlarmCode: Inverter alarm code

Vbus1: Voltage of BUS1

Vbus2: Voltage of BUS2

VbusP: Positive BUS voltage

VbusN: Negative voltage of the BUS

T1: Temperature of the I/O board (the highest value). Normal <87°C; Warning >87°C; Fault ≥95°C

T2: Temperature of the motherboard (take the highest value). Normal <90°C; Warning >90°C; Fault ≥105°C

ExitReason1: Used by engineering for debugging. This should be blank unless there is an issue.

ExitReason2: Used by engineering for debugging. This should be blank unless there is an issue.

Run_Trace: Used by engineering for debugging. This should be blank unless there is an issue.

< Solar	Battery	Grid	UPS	Other >
Status:	PVCharge			
NextStatus:	Standby			
FaultCode:	0000 0000			
AlarmCode:	0000 0000			
Vbus1:	0.0V	Vbus2:	0.0V	
VbusP:	0.0V	VbusN:	0.0V	
T1:	0.0°C	T2:	0.0°C	
ExitReason1:	0000 0000			
ExitReason2:	0000 0000			
Run_Trace:	0			

12.6 NOTICE MENU

Fault Status Tab

When the inverter has an internal fault, this page displays the corresponding fault code.

If there is no fault, no fault is displayed.

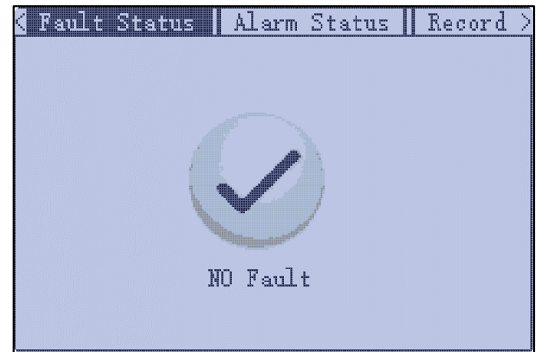

Alarm Status Tab

When the inverter goes into alarm status, this page will display the corresponding alarm code.

If there is no alarm, NO Alarm is displayed.



Record Tab

There are eight pages that contain informational history of Failures and alarms along with the specific time and date of the failure or alarm.

The fault history is displayed on pages 1 to 4. Pages 5 to 8 displays record history.

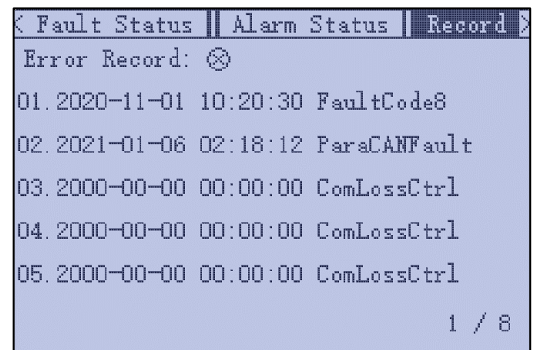

12.7 SETTINGS MENU

The information below describes each setting that can be configured by the end user. The default value for each setting will be underlined in the examples below.

Common Tab

(Page 1 / 2)

Normal/Standby: Standby | Normal

When the inverter is set to Standby mode, PV input and battery charging/discharging are inoperable. If the grid power is available, the Grid bypass relay will close, and the grid will power the loads.

PV Input Mode: DC source input | Two MPPT connect to same string | Two MPPT connect to different strings

Select “Two MPPT to same string” when connecting strings to the same MPPT. This will parallel both strings into one at the inverter. Two MPPT connected to different strings will keep each string as an individual string.

Battery Type: No battery | Lead acid | Lithium

Select the battery type connected to the inverter.

Lithium Type: EG4 | (See battery compatibility list on EG4® Electronics web site for more info)

Select the battery brand to support closed-loop battery communication.

Green Function Enable: Disable | Enable

When enabled, the inverter will work in green mode if EPS power output is less than 1W for 10 seconds. When in green mode, the EPS will only output for 200 ms every 3 seconds to save energy. If a load is detected to be greater than 7W on a single phase or a total of 12W between two phases, the inverter will exit green mode and return to normal EPS output.

Battery ECO Enable: Disable | Enable

When enabled, the inverter will switch to bypass mode if the battery has reached the On-Grid EOD value and AC charging is disabled. The inverter will stay in bypass mode until the battery is being charged again. When enabled, switch over time may be increased up to 15 ms.

ISO Enable: Disable | Enable

Detects and protects when the input insulation of the solar panels is lower than the required value set by safety regulations.

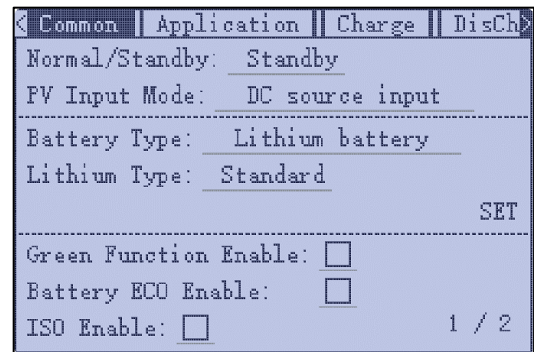

(Page 2 / 2)

Set Time: [year–month–day] [hour: minute: second]

When the inverter is online, the time is based on the set Time Zone. The time zone can be set using Monitor Center by going to Configuration Tab, Station, Station Management, Edit page, then set the time zone and daylight savings time

Buzzer Enable: Enable | Disable

Enable or disable the alarm (includes navigation key presses).

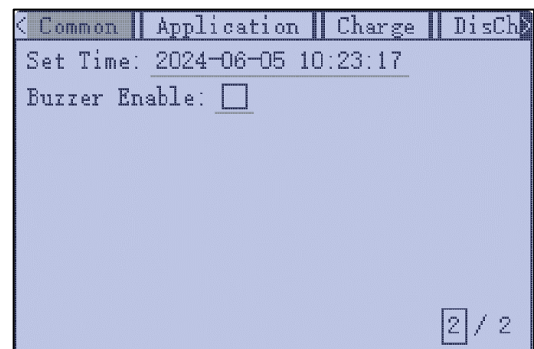

Application Tab

(Page 1 / 3)

EPS Voltage Set: 120/240 | 127/220 three phase | 100/200 split phase | 120/208 | 110/220 | 115/230

Set the inverter output voltage.

EPS Frequency Set: 60Hz | 50Hz

Set the inverter output frequency.

AC Input Range: UPS: 170-280 | APL: 90-280

Set the voltage range for AC Input. Switch over time will typically, be slower when APL is selected.

PV Grid Off: Disable | Enable

When enabled, provides off-grid functionality without using battery backup. Note, AC output is only supplied by solar which can cause output voltage instability due to fluctuating voltages from the solar modules. It is always recommended to install a battery or battery bank to keep the inverter output voltage stable.

N-PE Connect (Inner): Disable | Enable

Enable or disable the neutral ground bond inside the inverter. This is not a dynamic bond, meaning it is only disabled or enabled.

PV Arc: Disable | Enable

Enable detection of arcs on the PV input circuits and provides protection from PV circuit arcs.

PV Arc Fault Clear: Clear

Clears a fault detected due to arcs on the PV input circuit to the inverter.

RSD Enable: Enable | Disable

Enable or disable the Rapid Shut Down feature.

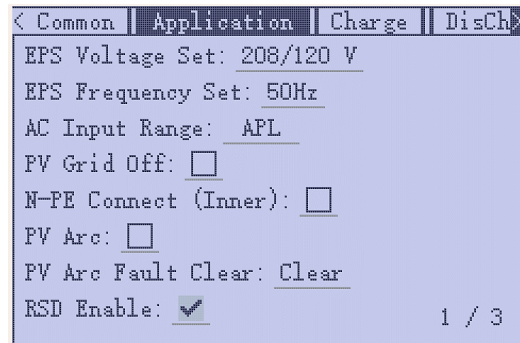

(Page 2 / 3)

AC First: Start 00:00 - End 00:00

The time at which the inverter will use only AC to power loads and uses all PV input to charge the battery.

The range is 00:00 – 23:59.

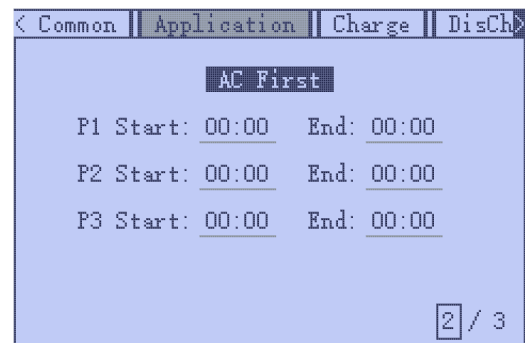

Application Tab (Cont.)

(Page 3 / 3)

Set System Type: Not Parallel | Single Phase Parallel | Three Phase Parallel

Set to “Not Parallel” when using a single inverter. Set to “Single Phase Parallel” when connecting two or more inverters using split-phase 120/240VAC. “Set to Three Phase Parallel” when composing a three-phase system using three or more inverters. This set setting can only be configured in standby mode or while in fault mode.

Set Composed Phase: Phase U | Phase V | Phase W

If the system is connected to the grid, the inverter will detect the phase it connects to automatically, record it and output the phase as it detected. If the user setting is different from the phase the inverter detected; it will still output the phase detected. The output phase record will be cleared if the customer clears it. If the system is not connected to the grid, the inverter will use the user output phase setting to compose the three-phase output. If the customer sets the wrong phase, i.e., 2 U phase and no W phase, the system will report errors. This setting can only be changed in standby mode or while in fault mode.

Battery Shared: Disabled | Enabled

Enable or disable the battery sharing functionality. Enable battery sharing when configuring more than one inverter in parallel mode sharing a battery bank.

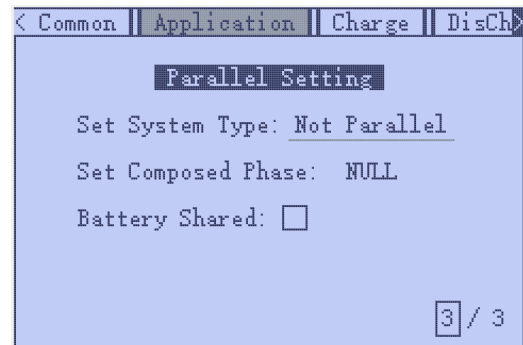

Charge Tab

(Page 1/3)

Charge Current Limit: 250A

Set the current charge limit in amps. Range is 0 – 250.

Lead-Acid Charge Voltage: 57.4V

Sets the lead acid charge voltage. See the battery manufacturer’s recommendation for setting this value. In order for lead-acid batteries to enter the absorption charge stage set the absorption voltage below Stop AC Charge Volt -1V. Range is 50 – 59V.

Lead-Acid Floating Voltage: 54.0V

Sets the lead acid floating voltage. See the battery manufacturer’s recommendation for setting this value. The inverter will enter float charge mode when the charge current is less than 0.01C. The float charge voltage should be less than Absorb Voltage. Range is 50 – 58V.

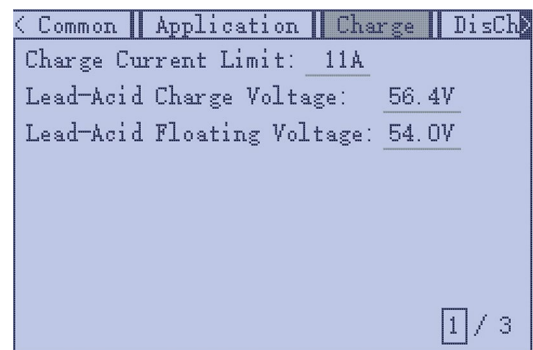

(Page 2 / 3)

AC Chg Based On: Disable | According to Time | According to Bat Voltage | According to Bat SOC | Battery Volt and Time | Battery SOC and Time

Enable and set AC charging method. This setting has multiple different sub options based on the charging method selected. See below for more information.

AC Chg Battery Current: 30A

Sets the current used for AC to charge the battery. Set according to the battery requirements. Range is 0 – 250A.

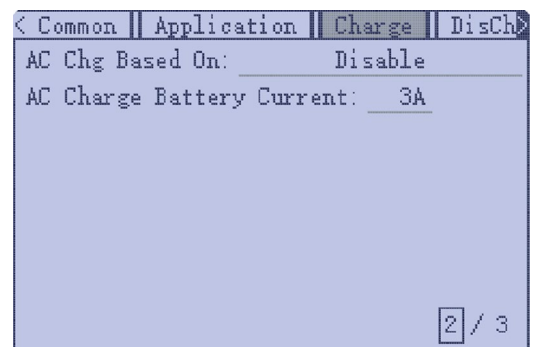

Charge Tab (Cont.)

(Page 2 / 3)

AC Chg Based On: According to time

AC charging is configured according to time using up to threetime periods. If one of the three time periods is met, AC will charge the battery. If only one time period is needed, it is recommended to set all time periods to the same value. Range is 00:00 – 23:59.

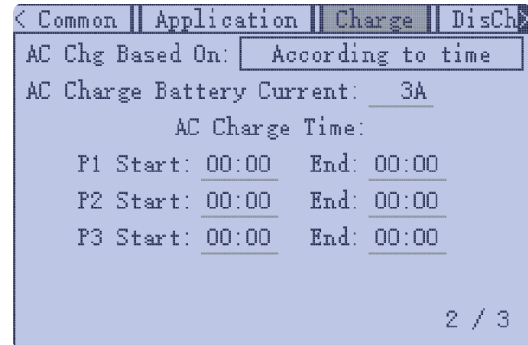

AC Chg Based On: According to Bat Volt

AC charging based on according to battery voltage. The starting charge voltage and ending charge voltage can be configured. If the battery voltage is within the start voltage and end voltage, AC will charge the battery. If using battery communications, it is recommended to use SOC instead of voltage (*see next setting*). Range is 38.4 – 57V for start a 48 – 59V for end.

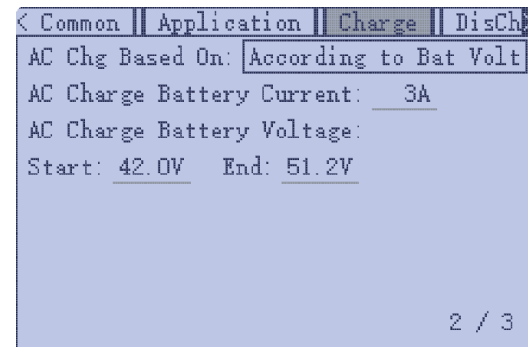

AC Chg Based On: According to Bat SOC

AC charging configured according to battery SOC. Start charge SOC and stop charge SOC can be set. If the battery SOC is within the start and end SOC, AC will charge the battery. Range is 1 – 90% for start and 20 – 100% for end.

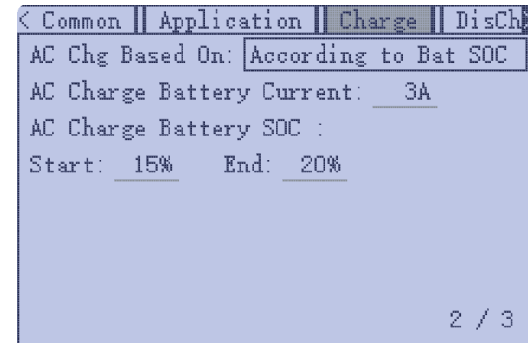

Charge Tab (Cont.)

(Page 2 / 3)

AC Chg Based On: Battery Volt and Time

AC charging is configured according to battery voltage and time. When one of the three time periods and the battery voltage is met, AC charging will begin. Once the time period and voltage are outside the configured range, AC charging will end. Voltage range is 38.4 – 57V for start and 48 – 59V for end. Time range is 00:00 – 23:59.

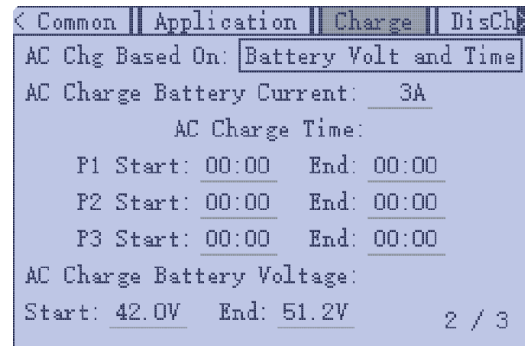

AC Chg Based On: Battery SOC and Time

AC charging is set according to battery SOC and time. AC will charge batteries when in one of the three time periods and when battery SOC is between the start charge SOC and the cut-off charge SOC, the battery will charge. SOC range is 1 – 90% for start and 20 – 100% for end. Time range is 00:00 – 23:59.

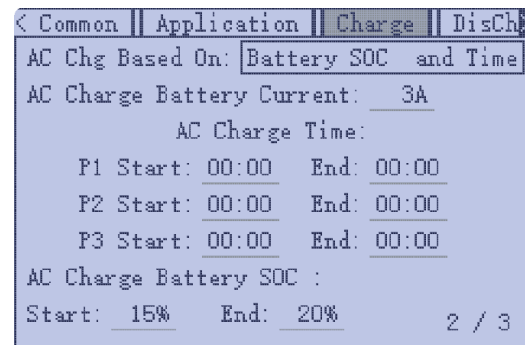

(Page 3 / 3) – **Generator Setting**

Generator Charge Type: Use Vol | Use SOC

Generator charging is set according to the battery voltage or battery SOC.

Gen Charge Bat Current: 30A

Set generator battery charging current. Range is 0 – 250A.

Gen Charge Start Bat Volt: 46.4V

Starts the generator using dry contacts when the battery voltage is below the generator charge battery voltage. Set according to the battery requirements. Range is 38.4 – 57V.

Gen Charge End Bat Volt: 38.4V – 57V

Stops generator using dry contacts when the battery voltage is above generator charge end battery voltage is above the set battery voltage. Set this according to the battery requirements. Range is 48 – 59 VDC.

Gen Charge Start Bat SOC: 20%

Starts the generator using dry contacts when battery SOC% is below the generator charge start battery SOC%. Set this according to the battery requirements. Range is 0 – 90%.

Gen Charge End Bat SOC: 100%

Stops the generator using dry contacts when battery SOC% is above the generator charge end battery SOC%. Set this according to the battery requirements. Range is 20 – 100%.

Max. Gen Input Power: 15000W

Set the maximum generator input power. The inverter will limit the power from the generator to 90% of the total generator capability to prevent overloading. Range is 0 – 15,000 watts for a single inverter and 0 – 65,534 watts for paralleled inverters.

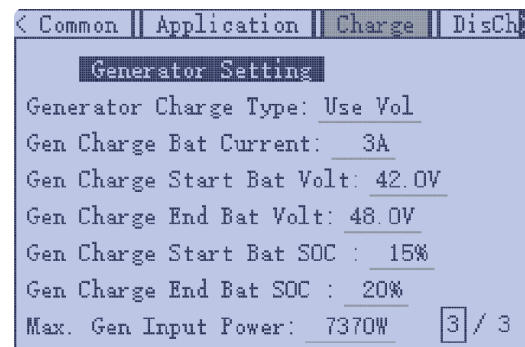

Discharge Tab

(Page 1 / 3)

Discharge Control: Use Vol | Use SOC

Battery discharge can be based on voltage or SOC. Set to “According to Voltage” when using a lead-acid battery or a lithium battery in lead-acid mode. Set to “According to SOC” when using a compatible Lithium battery.

Discharge Current Limit: 250A

Set the discharge current for lead-acid batteries. Set this according to the battery requirements. Range is 1 – 250A.

Battery Warning Volt: 44.0V

The inverter will display a battery low warning when the battery voltage falls to this value. Set this according to the battery requirements. Range is 40 – 56 VDC.

Discharge Cut-off Volt: 42.0V

Voltage at which the batteries will stop discharging in off-grid mode. When the battery reaches the cut-off voltage, the inverter will force charge +2V when grid available. Discharge will be restored after forced charge completes the 2V charging unless the battery voltage is still below 48V. The battery needs to be above 48V to allow discharge. Set this according to the battery requirements. Range is 40 – 56 VDC.

On Grid EOD Volt: 42.0V

When the set voltage is met, the inverter will change to on-grid mode. For example, if the voltage is set to 51 volts, the inverter will remain in off grid mode until the set battery voltage. At that point, the inverter will require power from the grid or from solar.

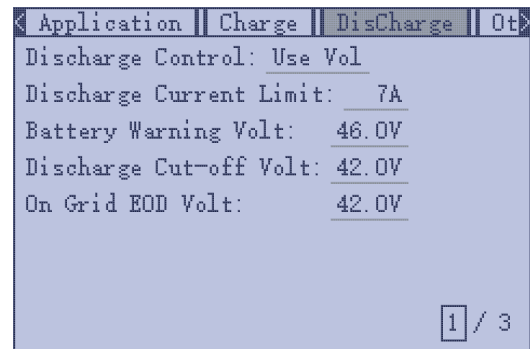

(Page 2 / 3) - **Smart Load**

Smart Load Enable: Disable | Enable

Turns the smart load feature on or off.

Start PV Power: 0.5kW

When the actual PV input power is greater than the value, the smart load function takes effect.

Grid Always On: Disable | Enable

Normally its enabled when connected to the grid.

Smart Load Start Volt: 54V

Set the voltage point at which smart load will take effect.

Smart Load End Volt: 48V

Smart load end voltage point.

Smart Load Start SOC: 90%

The SOC value smart load is enabled.

Smart Load End SOC: 60%

The SOC value smart load is disabled.

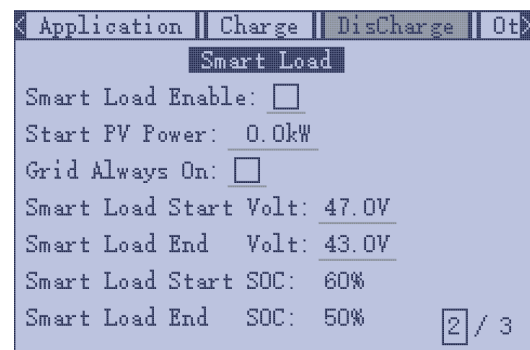

Discharge Tab

(Page 3 / 3) - **AC Coupling**

AC Couple Enable: Disable | Enable

Enables the AC coupling function.

AC Couple Start SOC: 50%

Sets the start state of charge (SOC) for AC coupling.

AC Couple End SOC: 90%

Configure the SOC for AC coupling.

AC Couple Start Volt: 50.0V

Configure the start voltage for the AC coupling.

AC Couple End Volt: 54.0V

Configure the end voltage for AC coupling.

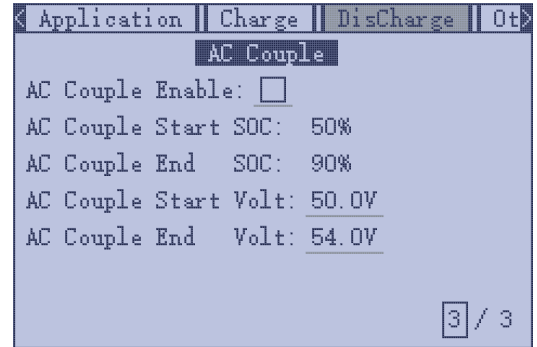

Other Tab

CT Power Offset: 0W

Configure the CT power offset.

Fan1 – Fan5 Slope: 70%

Enable or disable a custom fan speed slope for each fan. Range is 10 – 100%.

Fan1 – Fan5 Max Speed: 70%

Configure the maximum fan speed for each fan. Range is 0 – 100%.

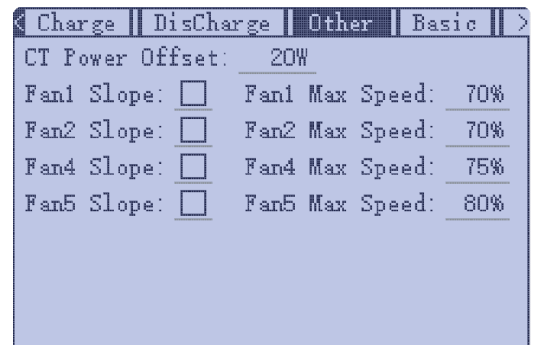

Basic Tab

SN: [inverter serial number]

Displays the inverter serial number.

FW: [inverter firmware version]

Displays the inverter firmware version.

Model: [inverter model number]

Displays the inverter model number.

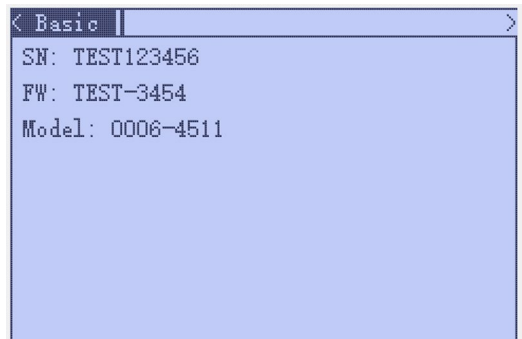

13. REMOTE MONITORING AND CONFIGURATION

The inverter can be remotely monitored and configured using the EG4® mobile app or by using EG4 Monitor Center with a web browser. This section describes configuring the inverter’s hardware (dongle) for access to the internet to support remote connectivity with the EG4 app or Monitor Center. For more information on using the EG4 app or the web browser, see the *EG4 Device Monitoring & Settings Guide*.



13.1 DONGLE INSTALLATION

There are three different hardware versions of the dongle that allow remote connectivity to the inverter. The first is a Wi-Fi dongle that is included with each inverter which connects to a local wireless network. The second hardware version is a LAN dongle that connects directly to a switch or router using an ethernet cable. The third hardware option is a 4G dongle that connects over a cellular network.

Installation Steps

1. Write down the dongle serial number and pin for easy access.
2. Attach the dongle to the inverter by plugging it into the dongle connector as shown in the image to the right.
3. Secure the dongle with the included 4 Phillips head screws.
4. The dongle Wi-Fi LED "📶" should illuminate after the dongle is plugged in and the inverter is powered on.
5. Once the dongle is plugged and the Wi-Fi LED is on, follow the steps in the next section to complete the dongle configuration for use with a user account.

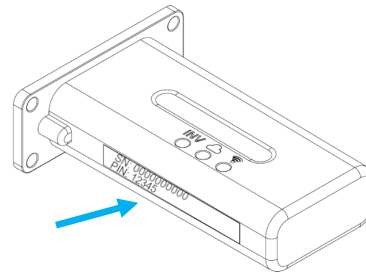

NOTE:

If the dongle Wi-Fi LED does not illuminate, see section 15 Dongle Troubleshooting.

New EG4 users will need to create a new account. Existing users can add the new dongle to an existing account, which is shown in section 13.3.

13.2 CREATE A NEW USER ACCOUNT

Using EG4 Monitor Center

1. Using a web browser, connect to “monitor.eg4electronics.com” and select on “Register”.

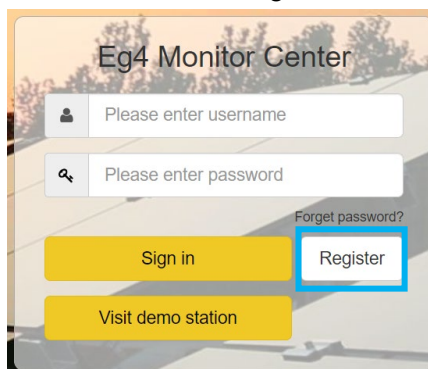

2. Complete the online form. Contact the distributor for the customer code. The dongle serial number (SN) and dongle PIN can be found on the sticker attached to the side of the dongle.

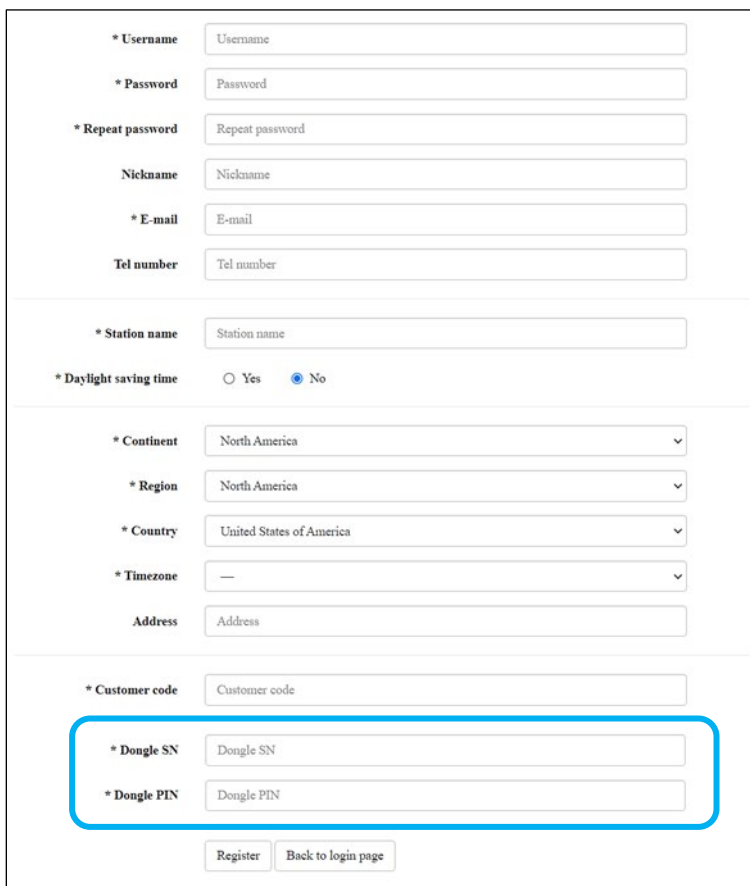

The registration form contains the following fields and options:

- * Username: Username
- * Password: Password
- * Repeat password: Repeat password
- Nickname: Nickname
- * E-mail: E-mail
- Tel number: Tel number
- * Station name: Station name
- * Daylight saving time: Yes No
- * Continent: North America
- * Region: North America
- * Country: United States of America
- * Timezone: —
- Address: Address
- * Customer code: Customer code
- * Dongle SN: Dongle SN
- * Dongle PIN: Dongle PIN

Buttons: Register, Back to login page

3. Once the registration is complete, return to the EG4® Monitor Center web page and login using the username and password created during the registration process.

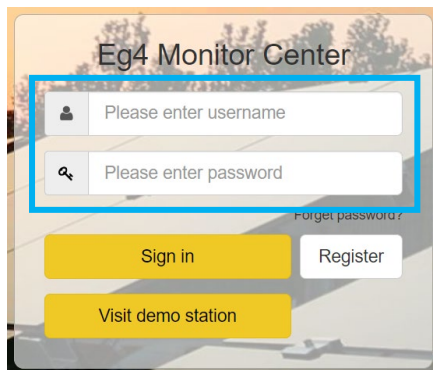

The login page features the following elements:

- Header: Eg4 Monitor Center
- Username field: Please enter username
- Password field: Please enter password
- Link: Forget password?
- Buttons: Sign in, Register, Visit demo station

Using the Phone App

1. Download the “EG4 Monitor” app for iOS or Android. After installation is complete, open the app.
2. Select “Register”, then complete the required information and press “Register”. Contact the distributor for the installer code.

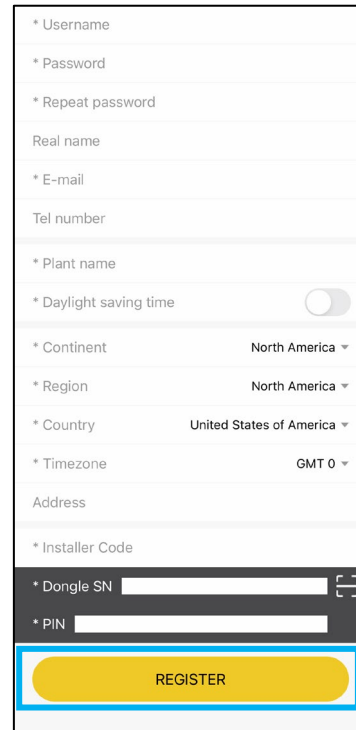
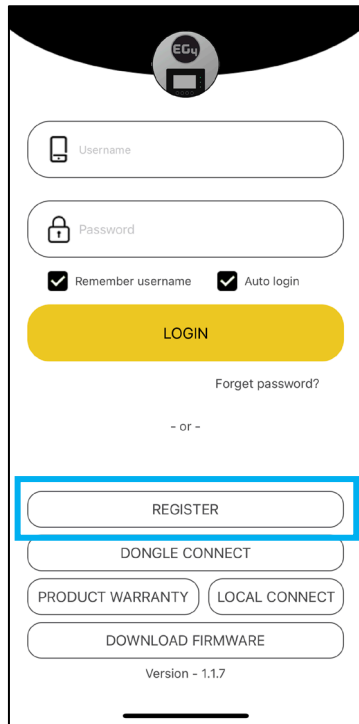

3. Once the registration is complete, return to the login page and login using the username and password created during the registration process.

13.3 EXISTING USER ACCOUNTS

When an EG4® account already exists, new EG4 hardware that uses a dongle can be added to the existing account. This can be completed using the Monitor Center or using the phone app.

Using EG4 Monitor Center

1. Using a web browser, open “monitor.eg4electronics.com” and login with the existing username and password.

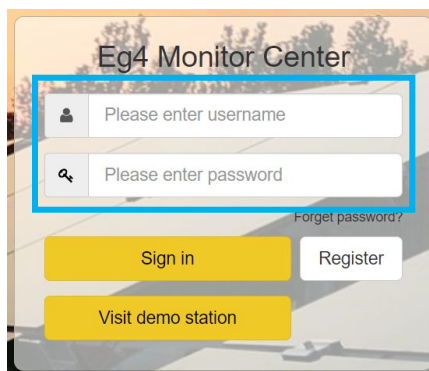

- Navigate to the “Configuration” tab, then select “Dongles”.
- Select “Add Dongle”.
- Enter the new dongle serial number and pin, select the station to assign the dongle to, then click” Add”.
- The EG4® 12000XP Off-Grid inverter should now be available in Monitor Center.

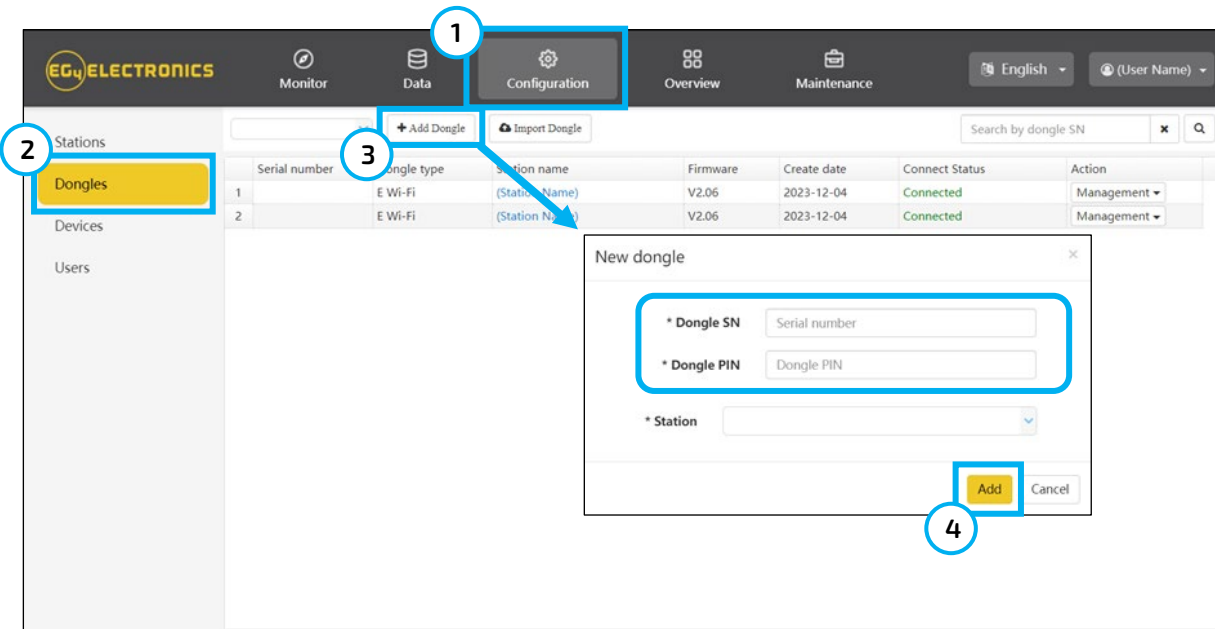

Using the Phone App

- Open the “EG4 Monitor” app and login using an existing name and password.
- Select the back arrow in the upper left corner of the screen.
- Select “Add Dongle”. Scan or enter the dongle information located on the dongle sticker, then press “Add Dongle”.

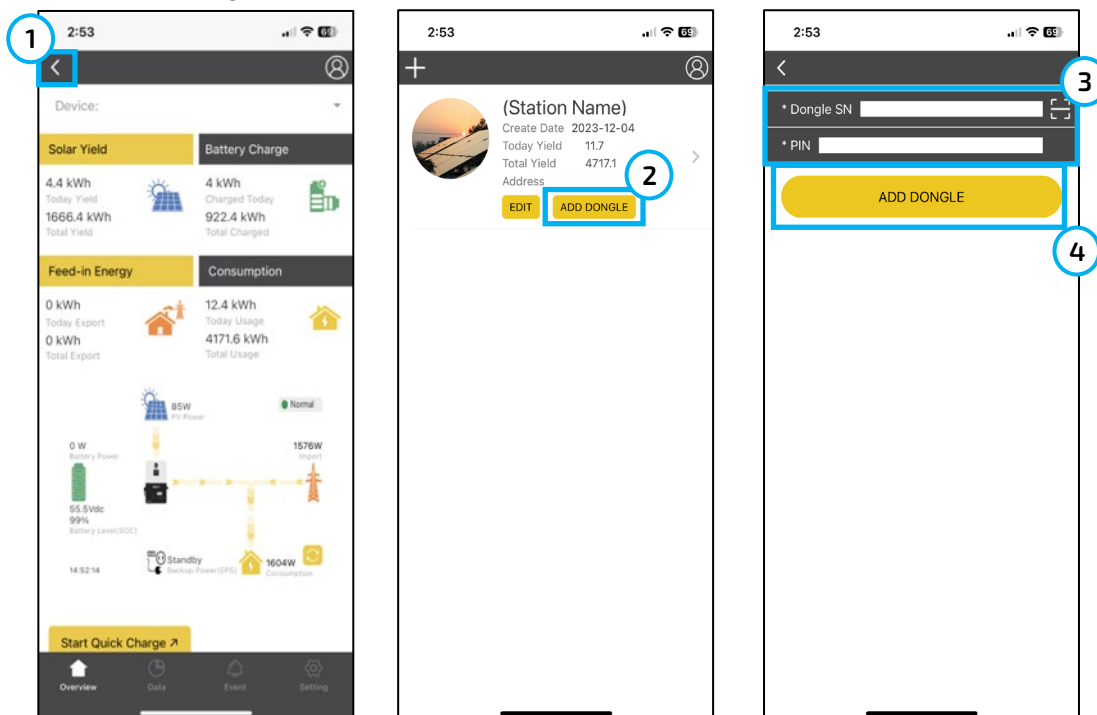

14. MONITOR CENTER SETTINGS

This section describes using Monitor Center to configure basic settings as well as settings that may be specific to the 12000XP. For assistance using additional settings and features within Monitor Center, see the EG4® Monitor Center Overview available on the EG4 website or by scanning the code below.

EG4 Monitor Center Overview



14.1 COMMON SETTING

Common Setting

Time (?) Set

PV Input Mode (?) Set

Model

Battery Type (?)

Lithium Type (?) Set

Lead-acid Capacity (?)

Normal / Standby (?)

Battery ECO Enable (?)

Buzzer Enable (?)

Restart Inverter (?)

- **Time:** Set the time/date of the inverter. The input format is 2019-02-14 14:44:00 (YYYY-MM-DD HH:MM:SS).
- **PV Input Mode:** The connection type of solar modules.
- **Battery Type:** Choose the “Battery Type” and then select Lithium Brand (for closed-loop communications), or battery capacity for lead-acid/lithium batteries with no communications. *Note: after setting the battery type, all other settings will reset to default.*
- **Lithium Type:** This setting allows the user to select from a list of compatible batteries for closed-loop communications.
- **Lead-acid Capacity:** Select the total battery capacity for lead-acid battery banks.
- **Normal / Standby:** When the inverter is set to Standby mode, PV input and battery charging/discharging are inoperable. If the grid power is available, the Grid bypass relay will close, and the grid will power the loads.
- **Battery ECO Enable:** When enabled, the inverter will switch to bypass mode if the battery has reached the On-Grid EOD value and AC charging is disabled. The inverter will stay in bypass mode until the battery is charged again. When enabled, switch over time may be increased up to 15 ms.
- **Buzzer Enable:** Enable or disable the alarm.
- **Restart inverter:** Restarts the inverter.

14.2 APPLICATION SETTING

Application Setting

EPS Voltage Set(V) (?) <Empty>

AC Input Range (?) <Empty>

PV Arc

RSD

EPS Frequency Set(Hz) (?) <Empty>

PV Grid Off (?)

PV Arc Fault Clear

N-PE Bond (?)

AC First (?)

AC first Start Time 1 (?) [0, 23] : [0, 59]

AC first End Time 1 (?) [0, 23] : [0, 59]

AC first Start Time 2 [0, 23] : [0, 59]

AC first End Time 2 [0, 23] : [0, 59]

AC first Start Time 3 [0, 23] : [0, 59]

AC first End Time 3 [0, 23] : [0, 59]

Parallel Settings

Set System Type (?) <Empty>

Set Composed Phase (?) <Empty>

Battery Shared (?)

Grid Loss Warning Clear

- **EPS Voltage Set(V):** Set the voltage to accommodate the rated grid voltage.
- **EPS Frequency Set(Hz):** Set the inverter output frequency.
- **AC Input Range:** Set the voltage range for AC Input. Switch over time will typically, be slower when APL is selected.
- **PV Grid Off:** When enabled, provides off-grid functionality without using battery backup. Note, AC output is only supplied by solar which can cause output voltage instability due to fluctuating voltages from the solar modules. It is always recommended to install a battery or battery bank to keep the inverter output voltage stable.
- **PV Arc:** The inverter will detect when there is an arc fault on the PV inputs in order to protect itself from potential damage.
- **PV Arc Fault Clear:** Clear the records of PV arc fault.
- **RSD:** The rapid shut-down detection of the PV inputs.
- **N-PE Bond:** Enable or disable the neutral ground bond inside the inverter. This is not a dynamic bond, meaning it is only disabled or enabled.

AC First

- **AC first Start Time (1 – 3):** The time at which the inverter starts to use only AC to power loads and uses all PV input to charge the battery. The range is 00:00 – 23:59.
- **AC first End Time (1 – 3):** The time at which the inverter ends the use of only AC to power loads and all PV input to charge the battery. The range is 00:00 – 23:59.

Parallel Settings

- **Set System Type:** Set to “No Parallel” when using a single inverter. Set to “Single Phase Parallel” when connecting two or more inverters using split-phase 120/240VAC. “Set to Three Phase Parallel” when composing a three-phase system using three or more inverters. This setting can only be configured in standby mode or while in fault mode.
- **Battery Shared:** Enable or disable the battery sharing functionality. Enable battery sharing when configuring more than one inverter in parallel mode sharing a battery bank.
- **Set Composed Phase:** If the system is connected to the grid, the inverter will detect the phase it connects to automatically, record it and output the phase as it detected. If the user setting is different from the phase the inverter detected; it will still output the phase detected. The output phase record will be cleared if the customer clears it. If the system is not connected to the grid, the inverter will use the user output phase setting to compose the three-phase output. If the customer sets the wrong phase, i.e., 2 U phase and no W phase, the system will report errors. This setting can only be changed in standby mode or while in fault mode.

14.3 CHARGE SETTINGS

Charge Setting

Charge Current Limit(Adc) (?) [0, 250/65534] Set

Lead Acid

Charge Voltage(V) (?) [50, 59] Set

Floating Voltage(V) (?) [50, 56] Set

Equalization Voltage(V) (?) [50, 59] Set

Equalization Period(Days) (?) [0, 365] Set

Equalization Time(Hours) (?) [0, 24] Set

AC Charge

AC Charge Based On (?) <Empty> Set

AC Charge Battery Current(A) (?) [0, 250] Set

AC Charge Start Time 1 [0, 23] : [0, 59] Set

AC Charge Start Time 2 [0, 23] : [0, 59] Set

AC Charge Start Time 3 [0, 23] : [0, 59] Set

AC Charge End Time 1 [0, 23] : [0, 59] Set

AC Charge End Time 2 [0, 23] : [0, 59] Set

AC Charge End Time 3 [0, 23] : [0, 59] Set

AC Charge Start Battery Voltage(V) (?) [38.4, 57] Set

AC Charge End Battery Voltage(V) (?) [48, 59] Set

AC Charge Start Battery SOC(%) (?) [1, 90] Set

AC Charge End Battery SOC(%) (?) [20, 100] Set

Generator Charge

Generator Charge Type (?) <Empty> Set

Generator Charge Battery Current(A) (?) [0, 250] Set

Generator Charge Start Battery Voltage(V) (?) [38.4, 57] Set

Generator Charge End Battery Voltage(V) (?) [48, 59] Set

Generator Charge Start Battery SOC(%) (?) [1, 90] Set

Generator Charge End Battery SOC(%) (?) [20, 100] Set

Max. Generator Input Power(W) (?) [0, 7370/65534] Set

Generator Boost Enable Disable

- **Charge Current Limit(Adc):** Set the charge current limit in amps according to battery requirements. Range is 0 – 250 for a single inverter and 0 – 4480 for paralleled inverters.

Lead Acid

- **Charge Voltage(V):** Sets the lead acid charge voltage. See the battery manufacturer’s recommendation for setting this value. Range is 50 – 59V.
- **Floating Voltage(V):** Set the lead acid floating voltage according to the battery manufacturer’s recommendation. When using lead acid batteries, this value must be set lower than the charge voltage. Range is 50 – 58V.
- **Equalization Voltage(V):** When using lead acid batteries, range is 50 – 59V. When using lithium batteries in lead acid mode, set to 0.
- **Equalization Period(Days):** When using lead acid batteries, range is 0 – 365. When using lithium batteries in the lead acid mode, set to 0.
- **Equalization Time(Hours):** When using lead acid batteries, range is 0 – 24. When using lithium batteries in lead acid mode, set to 0.

AC Charge

- **AC Charge Based On:** According to Time: Set a preferred time period to charge the battery. Range is 00:00 – 23:59. According to Voltage: Set AC to charge the battery when it drops to a pre-set voltage. Range is 38.4 – 57V for start and 48 – 59V for end. According to SOC: Set AC to charge the battery when it drops to the pre-set SOC. Range is 1 – 90% for start and 20 – 100% for end. According to Time and Voltage/SOC: set a preferred time period and voltage/ SOC range to begin charging.
- **AC Charge Battery Current(A):** Sets the current used for AC to charge the battery. Set according to the battery requirements. Range is 0 – 100A.
- **AC Charge Start Time (1 – 3):** Start AC Charging according to these time settings. Range is 00:00 – 23:59.
- **AC Charge End Time (1 – 3):** Stop AC Charging according to these time settings. Range is 00:00 – 23:59.
- **AC Charge Start Battery Voltage(V):** Limit of voltage at which the system will start charging batteries from AC. Range is 38.4 – 57V for start.

- **AC Charge End Battery Voltage(V):** Limit of voltage at which system will stop charging batteries from AC. Range is 48 – 59V for end.
- **AC Charge Start Battery SOC(%):** Limit of SOC at which the system will start charging batteries from AC. Range is 1 – 90% for start.
- **AC Charge End Battery SOC(%):**Limit of SOC at which the system will stop charging batteries from AC. Range is 20 – 100% for end.

Generator Charge

- **Generator Charge Type:** Generator charging is set according to the battery voltage or battery SOC.
- **Generator Charge Battery Current(A):** Set the generator battery charging current. Range is 0 – 250A.
- **Generator Charge Start Battery Voltage(V):** Starts the generator using dry contacts when the battery voltage is below the generator charge battery voltage. Set according to the battery requirements. Range is 38.4 – 57V
- **Generator Charge End Battery Voltage(V):** Stops generator using dry contacts when the battery voltage is above generator charge end battery voltage is above the set battery voltage. Set this according to the battery requirements. Range is 48 – 59 VDC.
- **Generator Charge Start Battery SOC(%):** Starts the generator using dry contacts when battery SOC% is below the generator charge start battery SOC%. Set this according to the battery requirements. Range is 0 – 90%.
- **Generator Charge End Battery SOC(%):** Stops the generator using dry contacts when battery SOC% is above the generator charge end battery SOC%. Set this according to the battery requirements. Range is 20 – 100%.
- **Max. Generator Input Power(W):** Set the maximum generator input power. The inverter will limit the power from the generator to 90% of the total generator capability to prevent overloading. Range is 0 – 15,000 watts for a single inverter and 0 – 65,534 watts for paralleled inverters.
- **Generator Boost:** Enable or disable the generator boost feature. Enable to allow the inverter to pull supplemental power from both PV and battery whenever the generator power is not sufficient to handle all loads.

14.4 DISCHARGE SETTINGS

Discharge Setting

Discharge Control (?) <Empty> [Set]	Discharge Current Limit(Adc) (?) [0, 250/65534] [Set]
Battery Warning Voltage(V) (?) [40, 56] [Set]	Battery Warning SOC(%) (?) [0, 90] [Set]
Discharge Cut-off Voltage(V) (?) [40, 56] [Set]	Discharge Cut-off SOC(%) (?) [0, 90] [Set]
On Grid EOD Voltage(V) (?) [40, 58] [Set]	On Grid EOD SOC(%) (?) [10, 90] [Set]

AC Couple

AC Couple (?)

AC Couple Start Volt(V) [40, 59.5] [Set]	AC Couple Start SOC(%) [0, 80] [Set]
AC Couple End Volt(V) [42, 80] [Set]	AC Couple End SOC(%) [0, 100] [Set]

Smart Load

Smart Load (?)

Start PV Power(kW) (?) [0, 25.5] [Set]	Grid Always On (?) <input type="button" value="Enable"/> <input type="button" value="Disable"/>
Smart Load Start Volt(V) [40, 59] [Set]	Smart Load Start SOC(%) [0, 100] [Set]
Smart Load End Volt(V) [40, 59] [Set]	Smart Load End SOC(%) [0, 100] [Set]

- **Discharge Control:** Battery discharge can be based on voltage or SOC. Set to “According to Voltage” when using a lead-acid battery or a lithium battery in lead-acid mode. Set to “According to SOC” when using a compatible Lithium battery.
- **Discharge Current Limit(Adc):** Set the discharge current for lead-acid batteries. Set this according to the battery requirements. Range is 1 – 250A.
- **Battery Warning Voltage(V):** The inverter will display a battery low warning when the battery voltage falls to this value. Set this according to the battery requirements. Range is 40 – 56 VDC.
- **Battery Warning SOC(%):** The inverter will display a battery low warning when the battery SOC falls to this value. Set this according to the battery requirements. Range is 0 – 90%.
- **Discharge Cut-off Voltage(V):** Voltage at which the batteries stop discharging in off-grid mode. When the battery reaches the cut-off voltage, the inverter will force charge +2V when grid is available. Discharge will be restored after forced charge completes the 2V charging, unless the battery voltage is still below 48V. The battery needs to be above 48V to allow discharge. Set this according to the battery requirements. Range is 40 – 56 VDC.
- **Discharge Cut-off SOC(%):** SOC at which the batteries will stop discharging in off-grid mode. Off-grid cut-off SOC should be ≤ on-grid cut-off SOC. When the battery reaches the cut-off SOC, the inverter will force charge 3%. Discharge will be restored after forced charge completes 5% charging. Range is 0 – 90%.
- **On Grid EOD Voltage(V):** When the set voltage is met, the inverter will change to on-grid mode. For example, if the voltage is set to 51 volts, the inverter will remain in off grid mode until the set battery voltage. At that point, the inverter will require power from the grid or from solar.
- **On Grid EOD SOC(%):** When the set SOC is met, the inverter will change to on-grid mode.

AC Couple

- **AC Couple:** Enables the AC coupling function. Connect existing on-grid inverter to the smart loads port as an AC Coupled system.
- **AC Couple Start Volt(V):** Configure the start voltage for the AC Coupling.
- **AC Couple Start SOC(%):** Configure the start SOC for AC Coupling.
- **AC Couple End Volt(V):** Configure the end voltage for AC Coupling.
- **AC Couple End SOC(%):** Configure the end SOC for AC Coupling.

Smart Load

- **Smart Load:** Turns the smart load feature on or off.
- **Start PV Power(kW):** When the actual PV input power is greater than the value, the smart load function takes effect.
- **Grid Always On:** Enable for continuous AC power on the GEN port when connected to the grid.
- **Smart Load Start Volt(V):** Set the voltage point at which smart load will take effect.
- **Smart Load Start SOC(%):** The SOC percentage that smart load is enabled.
- **Smart Load End Volt(V):** Smart load end voltage point.
- **Smart Load End SOC(%):** The SOC percentage that smart load is disabled.

14.5 OTHER SETTING

Other Setting

Fan 1 Max Speed(%) (?)	<input type="text" value="[10, 100]"/>	<input type="button" value="Set"/>	Fan speed slope 1	<input type="button" value="Default"/>	<input type="button" value="New Slope"/>
Fan 2 Max Speed(%) (?)	<input type="text" value="[10, 100]"/>	<input type="button" value="Set"/>	Fan speed slope 2	<input type="button" value="Default"/>	<input type="button" value="New Slope"/>

- **Fan 1 – 5 Max Speed:** Sets the cooling fans maximum speed for fans 1 – 5. Range is 10 – 100%.
- **Fan speed slope 1 – 5:** Set to default or new slope.

14.6 RESET

Reset

- **All to Default:** Resets all settings on the inverter to default.

14.7 WORKING MODES

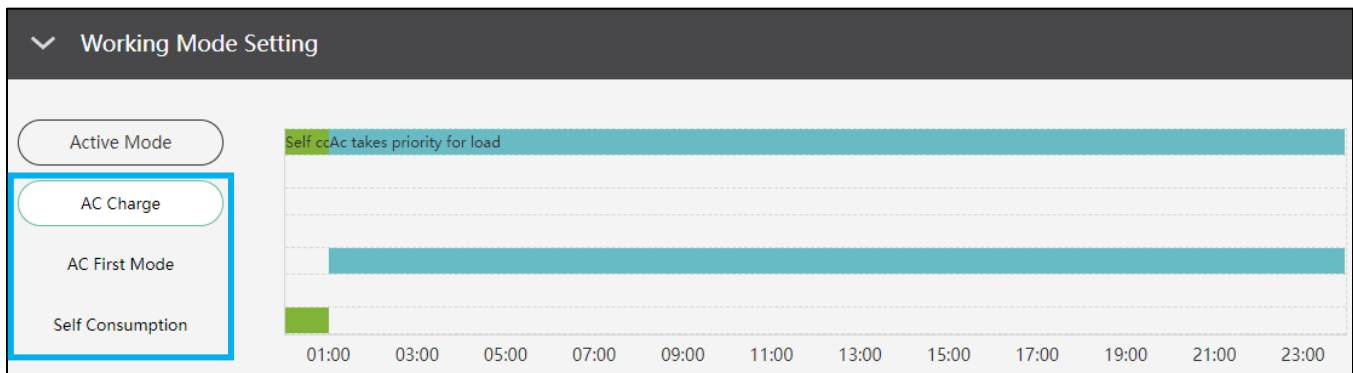

The “Working Mode” feature has several different preset working modes that allow the user to configure the system to meet their needs through customizing settings. Working modes for the EG4® 12000XP include AC Charge, AC First Mode, and Self Consumption.

- **AC Charge:** Used to charge battery bank with the grid while loads are supported by PV. Batteries can then be used when electricity prices are high.
- **AC First Mode:** Used to have AC power loads before using battery or PV. PV will charge while bypassing grid power.
- **Self Consumption:** The inverter will default to Self Consumption mode. Used to significantly lower grid consumption. Solar arrays power loads, then, when PV is insufficient, batteries power loads, and AC is only used as a last resort.

14.8 FIRMWARE UPDATE

To update the inverter firmware, follow the steps below:

1. The firmware can be updated by using the EG4® Electronics Monitor Center website. Contact EG4 to ensure the files are correct.
2. Log in to the Monitor Center. Select the “Maintenance” tab, and then select “Remote Update”.
3. Choose the inverter by serial number to update and then select “Standard Update”. The Monitor Center will begin updating both firmware files in the inverter. The latest version of the firmware will be displayed at the bottom right of the window.

The screenshot shows the EG4 Electronics Monitor Center interface. The top navigation bar includes Monitor, Data, Configuration, Overview, and Maintenance (selected). Below the navigation bar, there are options for 'Remote Set' and 'Weather Optimize'. A search bar for 'Serial number' is highlighted. Below the search bar, there is a table with columns: Serial number, Dongle, Firmware version, Connect Statu, and Action. The table contains one row with the following data: Serial number: 1, Dongle: (empty), Firmware version: ceaa-0202, Connect Statu: Connected, and Action: Standard Update (highlighted). A 'Remote Update' button is highlighted in the bottom left corner.



IMPORTANT:

Throughout the update, the inverter will automatically cycle power as it moves from one update to the next, however, if at any time an “Update Failed” alert appears, restart the full update from the first task. The “Update Failed” alert will only appear in the Monitoring Center. The software may need more than one attempt to update. If unable to successfully update the firmware, contact the distributor.

15. DONGLE TROUBLESHOOTING

15.1 LEDS & BUTTON FUNCTIONALITY

LEDs: Each of the three LEDs on the dongle will illuminate green when the boot/configuration process is complete.

1. **Wi-Fi LED:** Dongle has power, and the Wi-Fi hotspot is on.
2. **Cloud LED:** Dongle is communicating with the monitoring server.
3. **INV LED:** Dongle to inverter communication is established and functioning.

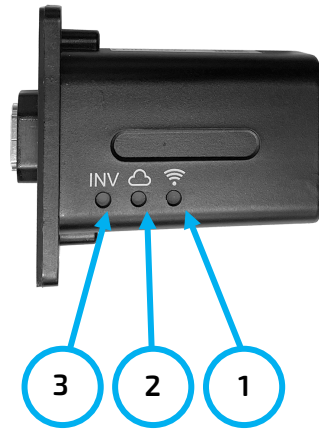

Bottom Button: When using dongle firmware version 2.0 or later, press the button on the bottom of the dongle to perform the following:

- Reboot the dongle - Hold down the button for 5 seconds, then release.
- Disable encryption - Hold down the button for 10 seconds, then release.

NOTE: It is recommended to use a small Phillips screwdriver or similar object to press the button to ensure it is being pressed in far enough to make the change. The dongle will not reboot until the button is pressed and held for 5 seconds.

15.2 DONGLE BOOTUP STEPS

The following steps describe the Wi-Fi dongle bootup sequence:

1. After the Wi-Fi Dongle receives power from the inverter and completes the first step in the bootup process, the Wi-Fi LED should be on. The dongle then creates a hotspot (*see image*) for supported devices to connect to.

NOTE: The dongle should automatically power-on if the inverter is on and the dongle is plugged into the dongle connector. If the Wi-Fi LED is not on, check the physical connection to ensure the dongle is completely seated into the connector on the inverter.

The dongle is hot-pluggable, meaning it can be removed and re-inserted with the inverter on.

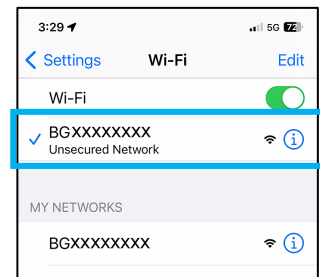

2. Once the dongle is properly configured, it should successfully connect to the home Wi-Fi network and then to the internet. The Cloud LED will illuminate once the dongle connects to the monitoring server via the internet.
3. Once the dongle has a connection to the monitoring server, it will then set up an internal connection to the inverter. When internal communication is successful, the INV LED is solid on.
4. When all three dongle LEDs are on, the inverter can be configured and monitored using the EG4® mobile app or the EG4 monitor website.

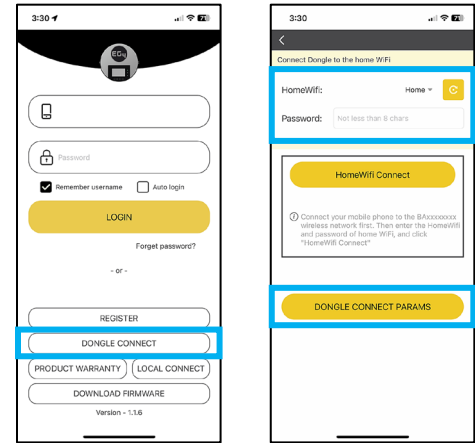

15.3 CONNECTIVITY REQUIREMENTS

Due to certain limitations of the Wi-Fi Dongle, ensure that the home Wi-Fi network signal and security settings meet the following requirements:

- The Wi-Fi Dongle only supports wireless networks in the 2.4GHz frequency band. If the router supports the 5GHz or 6GHz network frequencies, confirm the router supports the 2.4GHz network frequency band and it is enabled.
- The Wi-Fi Dongle is compatible with WPA1, WPA2, and WPA3 security protocols on the 2.4GHz network only.
- Ensure the Wi-Fi Dongle can obtain an IP Address by verifying the home Wi-Fi router has DHCP (Dynamic Host Configuration Protocol) setup and it is enabled.
- It is recommended the home Wi-Fi network name length does not exceed 19 characters, and the password length does not exceed 24 characters. It is not recommended to use any of the following special symbols in the password: @, #, \$, %, &, *, ?, _, /, or using a space “keyboard space bar”.

15.4 DONGLE PARAMETERS

The dongle network parameters can be used for troubleshooting various configuration and connectivity issues. This section describes the steps to view the dongle parameters along with a brief description for each parameter.

1. Verify the Wi-Fi LED is solid on. If the LED is not on, see section 15.2.
2. Using an iOS or Android device, connect to the Wi-Fi network created by the dongle, generally it's named as dongle serial number (i.e., BEXXXXXXXXX, BJXXXXXXXX, BGXXXXXXXX).

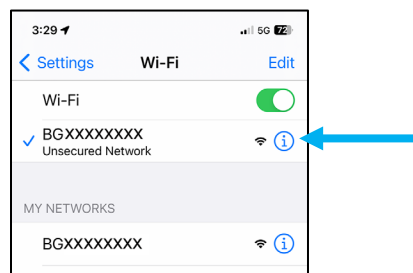

3. Open the EG4® app and select “Dongle Connect”. Then select “Dongle Connect Params”.

NOTE: If the home screen is bypassed after opening the EG4 app, press the user icon in the upper right of the screen and then select logout.

NOTE: After selecting Dongle Connect, give the dongle time to respond to the EG4 monitor mobile app. This could take up to 60 seconds based on connectivity strength.

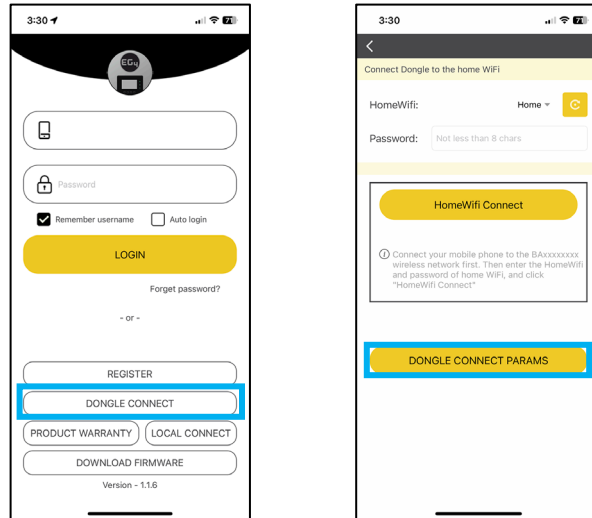

4. The configuration parameters used by the dongle when connecting and communicating over the Wi-Fi network are described below:

AP State		<p>This is the dongle’s IP address of the when it is acting as the access point to other Wi-Fi devices (i.e., phones, tablets, etc). This is also the gateway address attached devices use when communicating to the dongle via Wi-Fi. The dongle IP address 10.10.10.1/24 is pre-set at the factory and will always be the same.</p>
Function	Enable	
Ip	10.10.10.1	
Netmask		255.255.255.0
STA State		<p>This is the DHCP IP address the dongle received from the home Wi-Fi network. The gateway listed here is the IP address of the home Wi-Fi router. If the user knows the home Wi-Fi router password, the gateway address can be used to connect to the router if network parameters need to be changed. If the STA State area does not populate with an IP address, the dongle is not properly connecting to the home Wi-Fi router (network).</p>
Function	Enable	
Ip	192.168.1.74	
Netmask	255.255.255.0	
Gateway	192.168.1.1	
AP Parameter		<p>This area displays encryption information for the dongle’s Wi-Fi network, including the SSID of the dongle, if encryption mode is enabled or disabled, the encryption password, and a button to restart the dongle. Enabling encryption mode provides a level of security when connecting a device directly to the dongle. By default, any device can connect to the dongle without requiring a password (no security).</p>
SSID	BGXXXXXXX	
Encryption Mode	<input type="checkbox"/>	
AP Password	<input type="password"/> SET	
Restart Dongle	SET	
Station Parameter		<p>The SSID of the home Wi-Fi network, password, and connection state.</p>
SSID	Home	
Password	<input type="password"/>	
Connection State	Connected	
Network 1 State		<p>The protocol and address used to communicate with the EG4 monitoring server over the internet.</p>
Protocol	TCPClient	
Remote Port	3.1017.137	
Server Address(ip or domain)	4346	
TCP Client State	Connected	
Network 2 State		<p>Protocol and port used for internal communication between dongle and inverter.</p>
Protocol	TCPServer	
Local Port	8000	

15.5 TROUBLESHOOTING DONGLE NETWORK CONFIGURATION

Error: “Set failed” and/or “Set parameter failed”

Description: This error message may appear after selecting any button in the app that performs an action. For example, selecting the “HomeWiFi Connect” button as shown below.

Fix: Confirm the phone is connected to the dongle’s Wi-Fi network and the dongle’s wireless LED is illuminated. If those two conditions are met, wait a few minutes and retry the last step that failed. At times the dongle can become busy or slow to respond to the app.

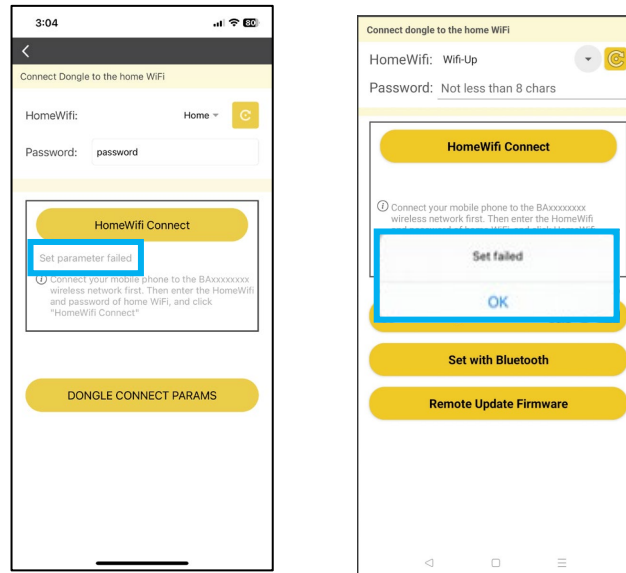

Error: Lost Hotspot Connection

Description: This error will occur when there is an issue connecting to the dongle hotspot properly, or the mobile device has disconnected from the dongle hotspot and is trying to connect using the mobile Cellular Network.

Fix: Verify the phone is not set up to connect to a cellular network when Wi-Fi connectivity is poor or is not providing a connection to the internet. The WLAN/Wi-Fi assist can be disabled or the Cellular can be temporarily disabled during the dongle setup process.

To disable WLAN and W-Fi assist perform the following:

- Android – Select Settings → select Cellular, then scroll down the page (screen). Locate ‘WLAN assistant’ and disable this setting.
- iOS – Select Settings → select Cellular, then scroll to the bottom of the page (screen). Locate “Wi-F- Assist” and disable this setting.

15.6 NETWORK SECURITY

Enabling:

The following steps describe the process of configuring and enabling WPA2 security for the dongle's wireless network:

1. Verify the Wi-Fi LED is solid on. If the LED is not on, see section 15.2.
2. Using a supported device, connect the Wi-Fi network created by the dongle, generally it's named as dongle serial number (i.e., BEXXXXXXXXX, BJXXXXXXXX, BGXXXXXXXX).
3. Open the EG4® mobile app and select "DONGLE CONNECT". Then select "DONGLE CONNECT PARAMS".

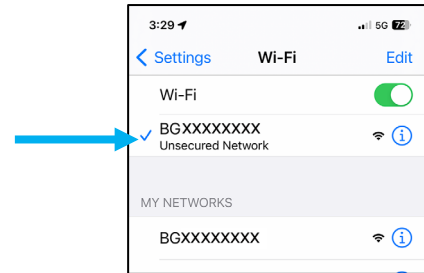

NOTE: If the home screen is bypassed when opening the EG4 app, press the user icon in the upper right of the screen and then select logout.

NOTE: After selecting "DONGLE CONNECT", give the dongle time to respond to the Phone app. This could take up to 60 seconds based on connectivity strength.

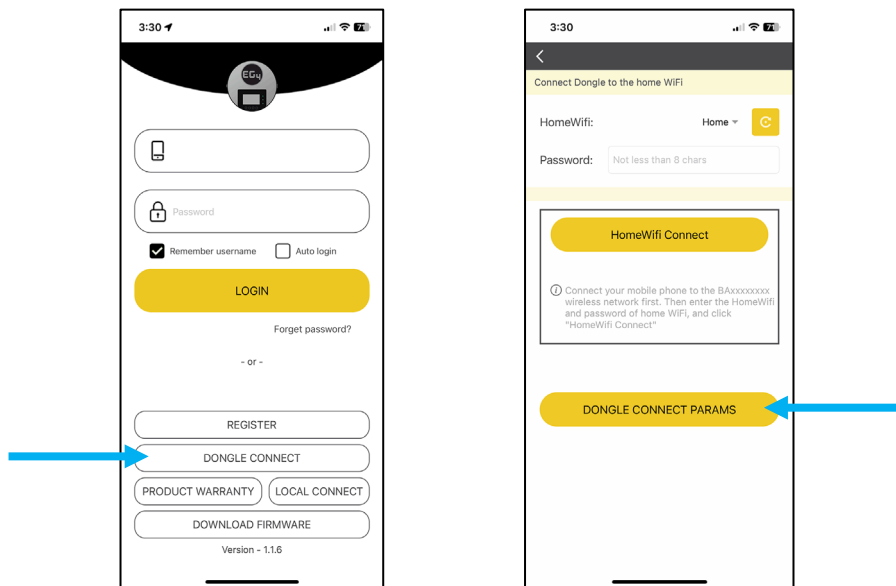

4. Select the Encryption Mode slider to start the configuration process. This step alone will not enable encryption. If the app is closed or the back arrow is pressed to move to the previous screen, this step will need to be completed again.

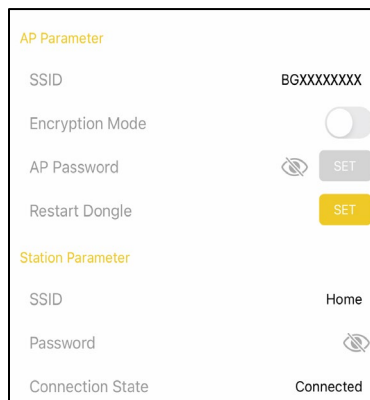

5. Select the “eye” icon and enter the verification code 123123. The “OK” button may need to be selected twice, depending on communication and/or software lag.

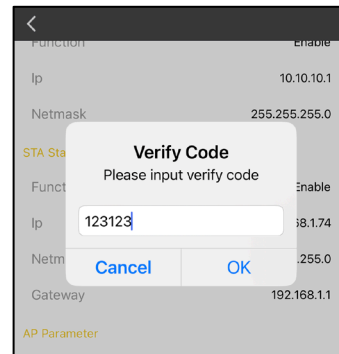
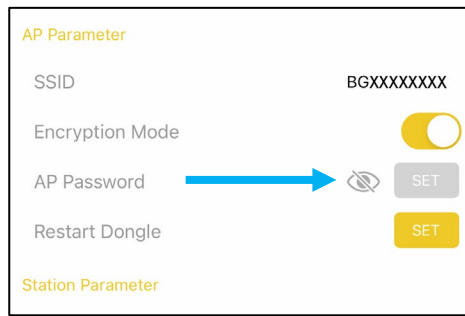

6. The default WPA2 password set at the factory is “12345678”. To change the default password, select inside the password area and over-write the existing password using the desired password. In the example below, the password is set to “Passw0rd!”. It’s also recommended to follow the password guidelines described in section 15.3.

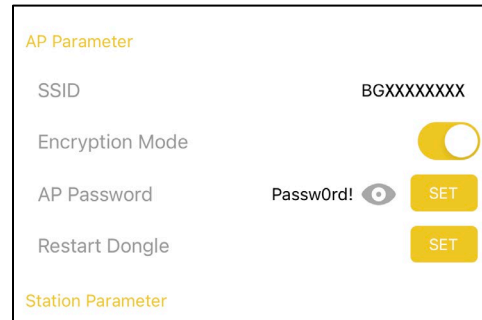
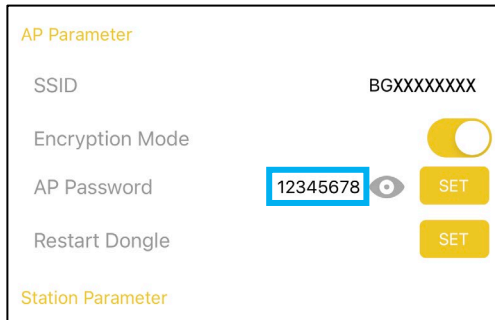

7. Select “SET” to save the password which will also enable WPA2 security. There may be a short pause after selecting the SET button. Press “OK” to verify the setup is complete. The dongle will reboot and should be back online within a couple minutes.

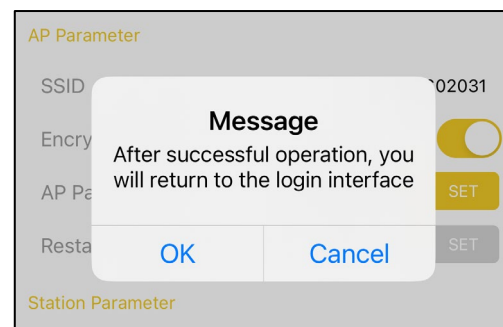
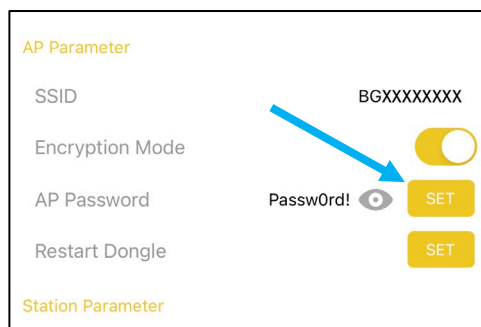

- Go to the phone's Wi-Fi settings and re-select the dongle's Wi-Fi network. The lock icon should appear next to the dongle's wireless network which means security is enabled. Enter the password created in the previous step.

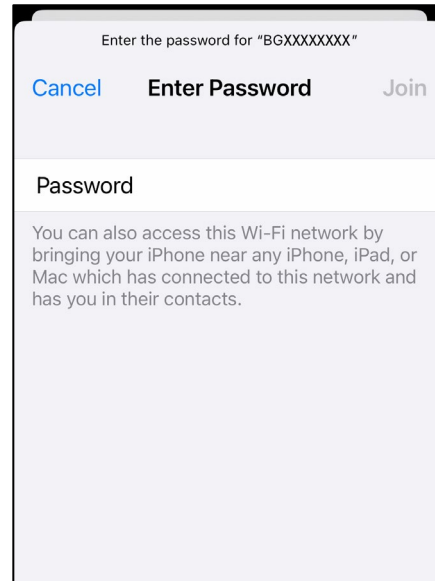
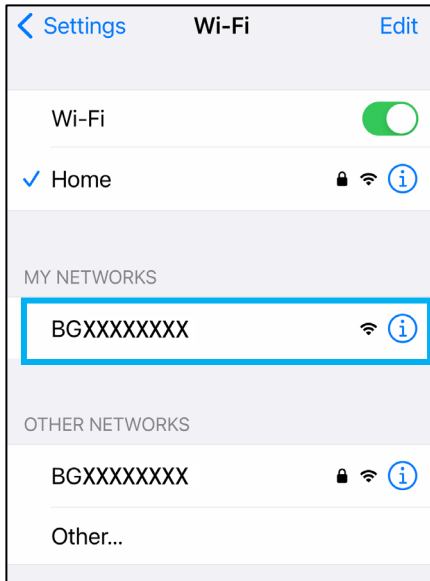

- The EG4® mobile app can now be used as it was previously when security was not enabled. Also note, enabling and setting up WPA2 security on the dongle's Wi-Fi network will not change the dongle's ability to connect to the home Wi-Fi network.

Disabling:

There are two options to disable the security settings for the dongle's network.

- Option 1:** Hold down the reset button on the bottom of the dongle for at least 10 seconds and release. This is the quickest and easiest option because it does not require using the currently set WPA2 password set on the dongle's Wi-Fi network.
- Option 2:** Use the EG4 App to disable the security settings on the dongle. This option can only be used if the WPA2 password is known. Follow the step list below:
 - Connect a phone to the dongle's Wi-Fi network. If the network was not previously saved on the current phone, enter the dongle's WPA2 password when prompted.
 - Open the EG4 app and select "DONGLE CONNECT".
 - Under AP Parameter area, select the slider button next to Encryption Mode to disable security.

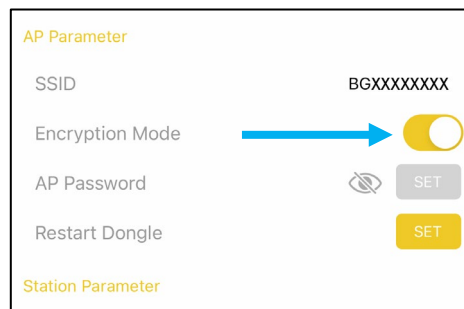

4. Press the “eye” icon and enter the verification code 123123.

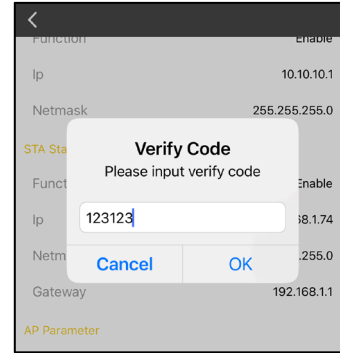
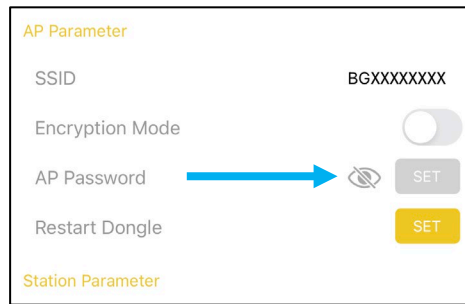

5. Select the “SET” button. There may be a short pause after selecting SET. If this step is not completed, security will NOT be disabled. Press “OK”, when prompted. The dongle will reboot, and security will be disabled after the reboot is complete.

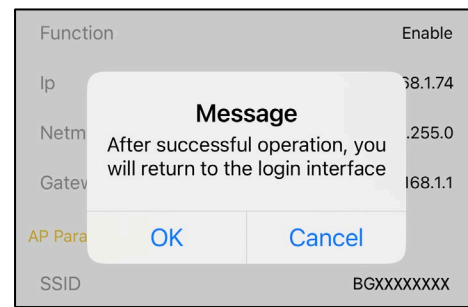
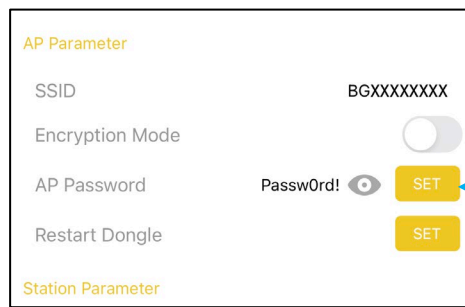

6. When selecting the dongle’s Wi-Fi network, the lock icon should no longer be displayed, and a password should not be required to connect to the dongle’s network.

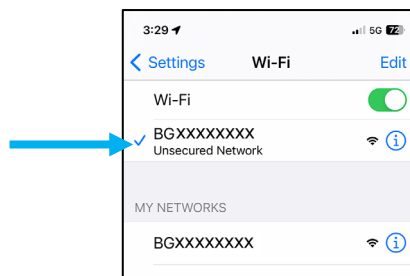

15.7 UPDATE DONGLE FIRMWARE USING APP

Before starting a dongle firmware update, verify all three LEDs are on and the dongle is online and has access to the monitoring server (EG4® Monitor Website). Dongle updates require downloading firmware from the server over the internet. If there are any issues connecting to the monitoring server, refer to section 13. Then connect the phone to the dongle's wireless network.



NOTE:

Before starting a firmware update, verify the EG4 mobile app is Android version 1.3.1 or later. Apple iOS does not currently support dongle FW updates.



REMINDER:

Before starting a dongle firmware update, verify all 3 LEDs are ON, the dongle is online, and the mobile device is connected to the dongle's Wi-Fi.

1. Connect the mobile device to the dongle's wireless network.
2. Open the EG4® app and select "DONGLE CONNECT".
3. The current dongle firmware will be displayed on the Update firmware button. Select the "Vx.xx Update Firmware" button to start the upgrade process. The EG4 app will automatically locate the latest firmware version available. At the time of this writing, the latest version in the image below is 2.06.
4. Select "Vx.x.x UPDATE FIRMWARE" to load the new firmware to the dongle.
5. The dongle FW should immediately load to the dongle followed by the message shown below. Press "OK" and wait for the dongle to reboot, which should not take more than a couple minutes. Once rebooted, verify the dongle firmware was updated using the dongle connect option in the app, or by using Monitor Center.

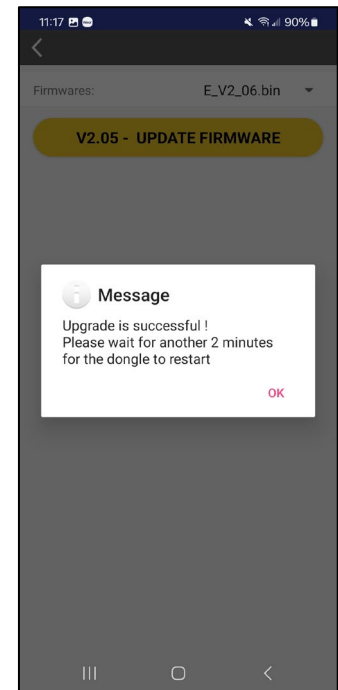
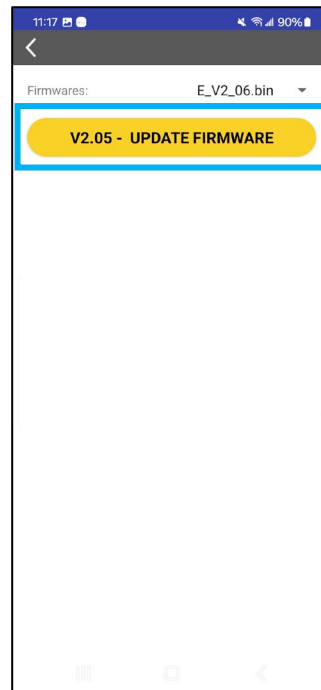
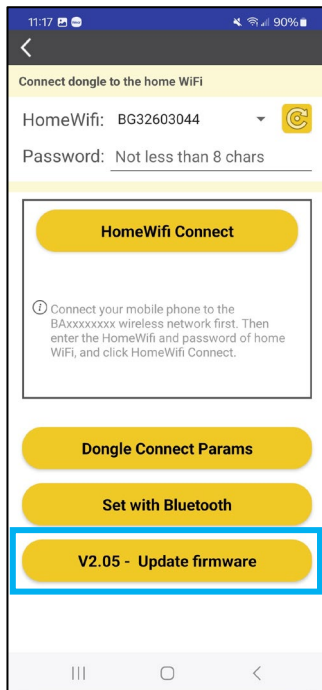

16. INVERTER TROUBLESHOOTING

16.1 ERROR DEFINITIONS AND TROUBLESHOOTING

CODE	DESCRIPTION	TROUBLESHOOTING
E000	Internal Communication Fault	Restart the inverter. If the error persists, contact the distributor.
E001	Model Fault	Restart the inverter. If the error persists, contact the distributor.
E003	CT Fail	Restart the inverter. If the error persists, contact the distributor.
E008	CAN communication error in parallel systems	Ensure the parallel cables are connected to proper ports between inverters.
E009	No master in parallel system	Check the parallel setting on each inverter to ensure there is only one inverter configured as the Master.
E010	Multi master in parallel system	There can be only one master in a parallel system. Check the parallel setting on each inverter to ensure there is only one inverter configured as the Master.
E012	Off-grid, short-circuit of the Load or Smart Load.	Check if the load has a short circuit. If not, turn the loads off and reset the system.
E013	UPS reserve current	Restart the inverter. If the error persists, contact the distributor.
E014	BUS short circuit	Restart the inverter. If the error persists, contact the distributor.
E015	Phase Error in three phase parallel system	Check if the AC connection is right for three phase system, there should one at least one inverter in each phase
E016	Relay fault	Restart the inverter. If the error persists, contact the distributor.
E017	Internal communication fault 2	Restart the inverter. If the error persists, contact the distributor.
E018	Internal communication fault 3	Restart the inverter. If the error persists, contact the distributor.
E019	Bus voltage too high	Check if PV input voltage is higher than 495V.
E020	LOAD connection fault	Check if LOAD and AC connection is in wrong terminal.
E021	PV voltage too high	Check PV input connection and if PV input voltage is higher than 480V.
E022	Hardware Over current	Restart the inverter. If the error persists, contact the distributor.
E023	Neutral fault	Verify the system is properly grounded.
E024	PV short	Check PV connections for short circuit.
E025	Temperature over range	The internal temperature of inverter is too high, turn off the inverter for 10 minutes, restart the inverter, if the error still exists, contact the distributor.
E026	Internal Fault	Restart the inverter. If the error persists, contact the distributor.
E028	Sync signal lost in parallel system	Ensure the CAN parallel cable is connected to proper ports between inverters.

E029	Sync trigger signal lost in parallel system	Ensure the CAN cable connection is connected to the correct COM port.
E031	Internal communication fault 4	Restart the inverter. If the error persists, contact the distributor.

16.2 WARNING DEFINITIONS AND TROUBLESHOOTING

CODE	DESCRIPTION	TROUBLESHOOTING
W000	Communication failure with battery	Check the inverter battery settings to ensure they are set for the specific battery type. Check the battery communications cable for proper pinning/installation.
W001	AFCI Com failure	Restart the inverter. If the error persists, contact the distributor.
W002	AFCI High	Check each PV string for correct open circuit voltage and short circuit current. If the PV strings are in good condition, clear the fault on inverter LCD.
W003	Meter communication failure	Check communications cable. If the error persists, contact the distributor.
W004	Battery BMS fault	Inverter is receiving a fault from the battery's BMS. Restart the battery and ensure the communication cables are installed correctly. If the error persists, contact the distributor.
W006	RSD Active	Check if the RSD switch is pressed.
W007	LCD communication fault	Restart the inverter. If the error persists, contact the distributor.
W008	Firmware mismatch	Contact the distributor for a firmware update.
W009	Fan Stuck	Verify the fans are operable.
W011	Stack overflow	Restart the inverter. If the error persists, contact the distributor.
W013	Over temperature	The temperature of the inverter is nearing the high limit.
W014	Multi-Master set in parallel system	There can be only one master in a parallel system.
W015	Bat Reverse	Double check battery connections to inverter are properly installed. If the error persists, contact the distributor.
W017	AC voltage out of range	Verify AC voltage is within operating range.
W018	AC Frequency out of range	Verify AC frequency is within operating range.
W019	AC inconsistent in parallel system	Ensure the AC input is from a common source and installed to each inverter in parallel. Restart the inverter. If the error persists, contact the distributor.
W020	PV Isolation low	Restart the inverter. If the error persists, contact the distributor.
W022	DC injection high	Restart the inverter. If the error persists, contact the distributor.
W025	Battery voltage high	Battery voltage is nearing the high limit.
W026	Battery voltage low	Battery voltage is nearing the low limit.

W027	Battery open	Check the battery for voltage using a multimeter. Ensure all wires are correctly installed to inverter and battery.
W028	Inverter overload	Inverter is running beyond maximum output.
W029	Inverter voltage high	Restart the inverter. If the error persists, contact the distributor.
W031	Load VDC high	Restart the inverter. If the error persists, contact the distributor.

CODE	STATUS	DESCRIPTION
0×00	Standby	Inverter is in standby status
0×02	FW Updating	Inverter is updating firmware
0×04	PV On-grid	When grid-tied, the PV system operates in two modes: 1. Excess solar power is fed into the grid when production exceeds demand. 2. It draws power from the grid when solar generation is less than demand.
0×08	PV Charge	Solar power exclusively charges the battery, with a maximum capacity limited by the battery's charging power. This mode commonly activates when the EPS switch is turned off.
0×0C	PV Charge On-grid	In hybrid mode with "PV & AC Take Load Jointly" enabled, when solar power surpasses load requirements, it's initially utilized to power the load. Any solar energy surplus beyond the load is then directed to charge the battery.
0×10	Battery On-grid	In hybrid mode with 'PV & AC Take Load Jointly' enabled, the inverter uses the battery to supply power to the load. If the battery capacity is insufficient to meet the load demand, the deficit is supplemented by drawing power from the grid.
0×11	Bypass	In off-grid mode, the inverter solely relies on grid power to supply the load. Solar power is dedicated exclusively to charging the battery, limited by the maximum charging capacity of the battery.
0×14	PV & Battery On-grid	In hybrid mode with 'PV & AC Take Load Jointly' enabled: 1. When solar power is less than the load power, both solar and battery sources jointly supply the load. 2. The inverter operates in the AC First time period. 3. During the AC Charge time period, if the AC Charge requirement is not fulfilled, the inverter continues in the AC Charge mode.
0×19	PV Charge + Bypass	In off-grid mode with 'PV & AC Take Load Jointly' disabled, the load is exclusively supplied by grid power. Solar power is dedicated solely to charging the battery and is limited to the maximum charging capacity of the battery.
0×20	AC Charge	Grid power is supplying load and charging battery simultaneously.
0×28	PV & AC Charge	Battery is being charged by solar and grid power simultaneously while the load is supplied by grid power.
0×40	Battery Off-grid	Grid power is cut, and battery power is used to supply the load.
0×80	PV Off-grid	Grid power is cut, and the inverter supplies the load with available solar power.

0xC0	PV & Battery Off-grid	Grid power is cut, and the inverter supplies the load with a combination of solar and battery power.
0x88	PV Charge Off-grid	Grid power is cut, and solar power is used to supply the load and charge batteries simultaneously.

17. INVERTER MAINTENANCE

Electrical equipment must be properly maintained to increase longevity and consistency. Follow the steps below to help prevent component damage/deterioration.

1. Inspect the inverter every month to confirm nothing covers the inverter heatsink. If it is covered, shut down the inverter and clear the heat sink to restore proper cooling.
2. Inspect the inverter every 3 months to verify the operating parameters are normal, and there is no abnormal heating or noise from any components in the system.
3. Inspect the inverter every 6 months to check for any damaged cables, accessories, or terminals.

If unable to identify the source of any potential abnormal operations, contact the distributor's technical support team for additional information.

17.1 INVERTER START-UP AND SHUT DOWN PROCEDURE

After the inverter has been commissioned, use the following steps to properly start up and shut down the inverter as needed.

Start-Up

Follow the steps outlined below to ensure proper start-up and shut down procedures to avoid potential component damage.

1. Power on the batteries one at a time, starting with the master, in ≈5 second intervals. Close the external battery breaker (if equipped).
2. Close (power on) the battery breaker on the master inverter.
3. Close (power on) the external PV isolator switch (if equipped). Close (power on) the PV switch on the side of the unit.
4. If using AC input, close (power on) the external breaker between panel and inverter. Next, close (power on) the GRID breaker on the front of the inverter.
5. Power on the inverter via the power switch on the side of the unit.
6. Close external AC Output breaker (if equipped) going to panel. Turn ON EPS Output (AC Output) switch on side of unit to begin powering loads.



DANGER:

Never disconnect battery, PV, or AC input power under loads. If there is an emergency where the inverter must be shut down, follow the steps outlined below.

Shut Down

1. Turn off EPS output on side of inverter.
2. Open (turn OFF) the GRID and GENERATOR breaker on front of unit.
3. Open the LOAD breaker on front of unit. Open the external AC output breaker (if equipped).
4. Open the external PV isolator switch. Open the PV switch on the side of the inverter.
5. Open Battery Breaker on front of unit. Open external battery breaker (if equipped).
6. Power down batteries one at a time starting with the master.
7. Turn power switch on side of the inverter to OFF.

18. WARRANTY INFORMATION

For information regarding warranty registration on EG4® Electronics products, please navigate to <https://eg4electronics.com/warranty/> and select the corresponding product to begin the registration process.

19. CHANGELOG

Version 1.2.0

- Updated multiple section references throughout document.
- Corrected section 10.1 to show relay contact description from “Normally Closed” to “Normally Open”.

Version 1.1.9

- Modified Max. Continuous Output Current to accommodate system update that allows 15000W continuous output.*
- Modified Nominal Power Output to accommodate system update that allows 15000W output.*
*This only applies to the updated model #: IV-15000-XP-IN-01
- Added footnotes to display output current and power output values for previous models.

Version 1.1.8

- Added additional information regarding “PV Input Mode” in sections 9.1 and 9.2
- Added battery wire strip length
- Added Max. PV Input Voltage to spec sheet and added additional footnotes regarding PV sizing.

Version 1.1.7

- Modified KO sizes in section 6.3 from 1 inch nominal to $\frac{3}{4}$ inch nominal
- Modified PV wire strip length requirement to $\frac{4}{5}$ ” (20 mm)
- Updated description of ISO Enable setting

Version 1.1.6

- Added Note quick-part in section 9.1 and 9.2 on communication protocol selection
- Modified verbiage in section 10.1 for External RSD
- Updated section number callouts to reflect TOC reorder

Version 1.1.5

- Updated images of PV terminals
- Updated images of physical unit to reflect changes
- Modified PV wire installation steps to accommodate new hardware
- Modified spec sheet to include updated certifications
- Added Locked Rotor Amps value to spec sheet
- Added additional wiring warning note to section 8.3 regarding neutrals
- Added French safety section
- Updated images for AC charge settings to more accurately reflect website

Version 1.1.4

- Modified verbiage on Packing List
- Modified low end battery charging setting from 39V to 38.4V
- Modified max. generator input power from 18000W to 15000W

11-25-24

- Modified external RSD wiring image in section 9
- Modified parallel switching time to 10ms in parallel, lowered from 20ms
- Modified max. number of units in parallel to 16
- Corrected minor spelling & formatting issues

11-12-24

- Published v1.1.3

11-11-24

- Minor formatting changes for consistency
- Modified Recommended Tools section
- Added callout for terminal block in Sec. 5.2
- Modified spec sheet
- Added Sec. 6.3 for Recommended Tools

11-4-24

- Added wiring information and wiring image to Sec. 9.1
- Modified Warranty Information section

11-2-24

- Published v1.1.2
- Modified opening paragraph in RSD section 9

10-31-24

- Altered spacing values in Sec. 6.2
- Moved Packing List section
- Minor formatting changes

10-15-24

- User manual published



CONTACT US

support@eg4electronics.com

(903) 609-1988

www.eg4electronics.com